

Spatial, Temporal, and Interpretive Limits of Functional MRI

Peter A. Bandettini, Ph.D

Unit on Functional Imaging Methods
&
3T Neuroimaging Core Facility

Laboratory of Brain and Cognition
National Institute of Mental Health

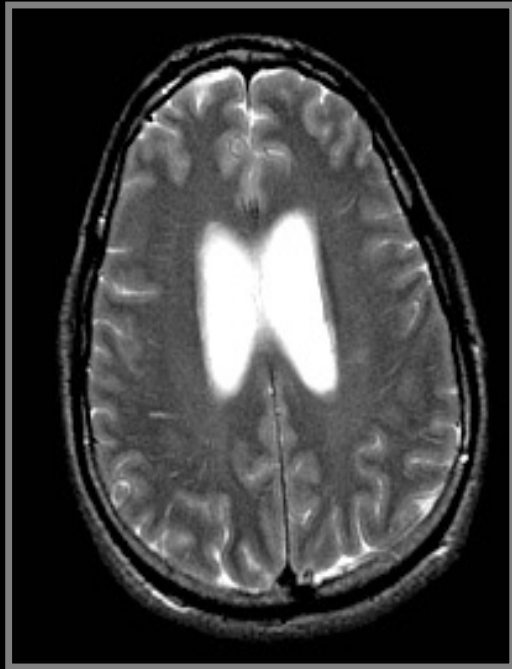

Anatomic

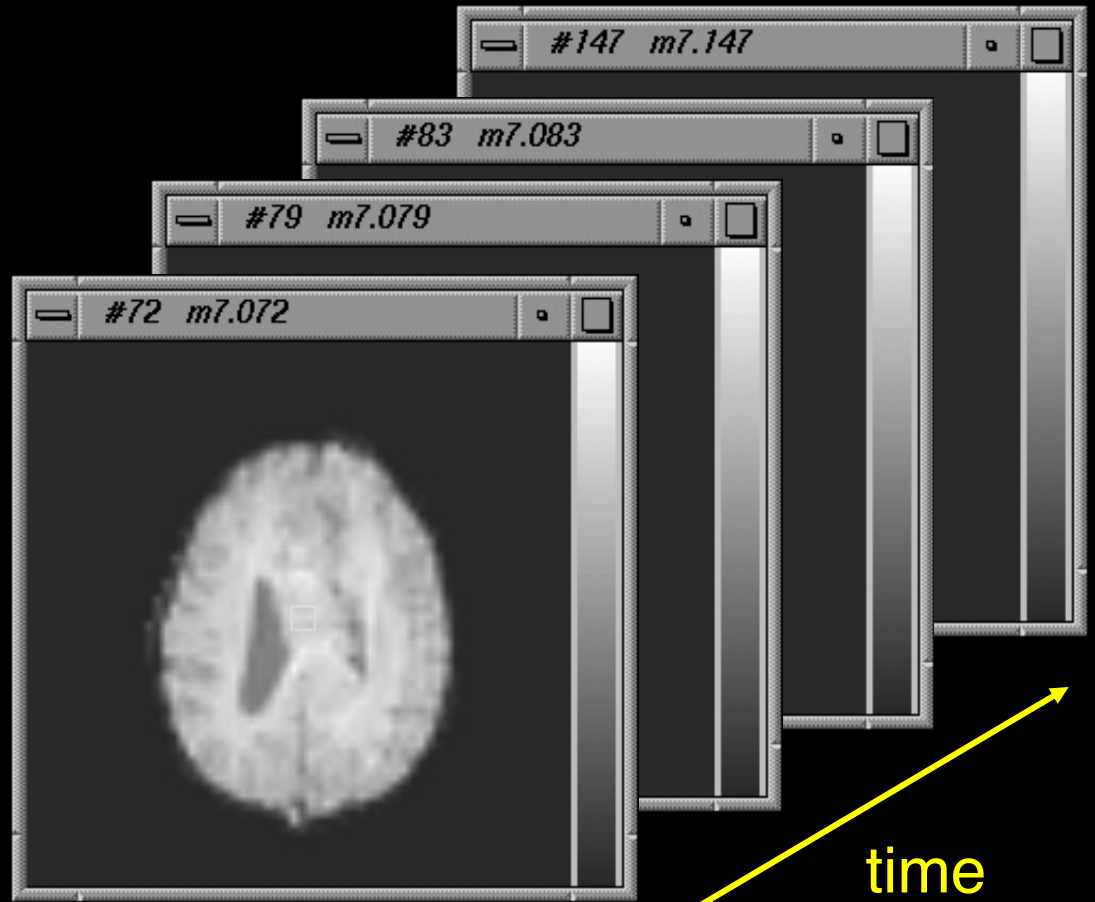

Functional

Echo-Planar Imaging

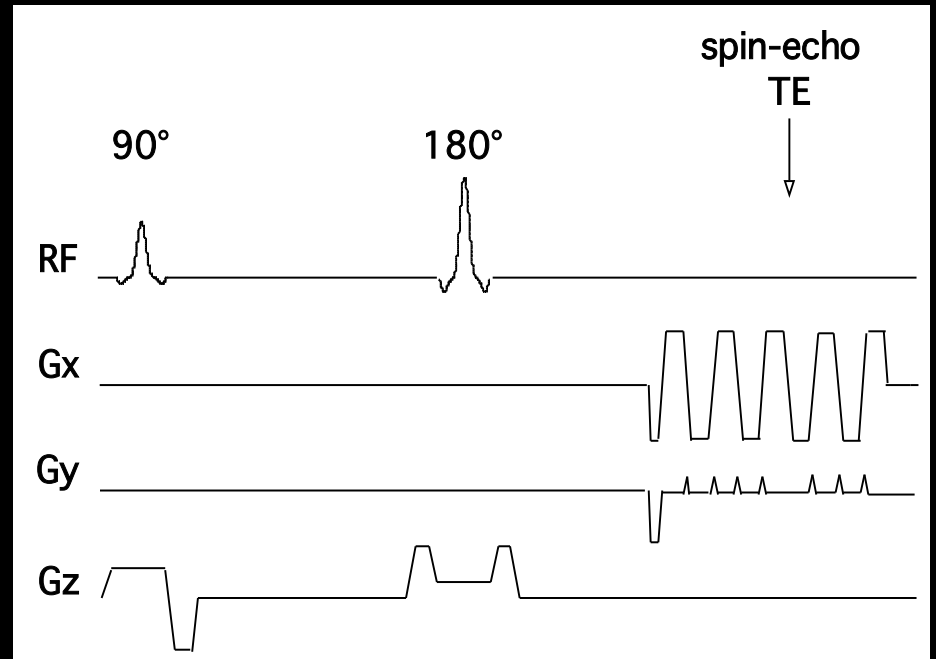
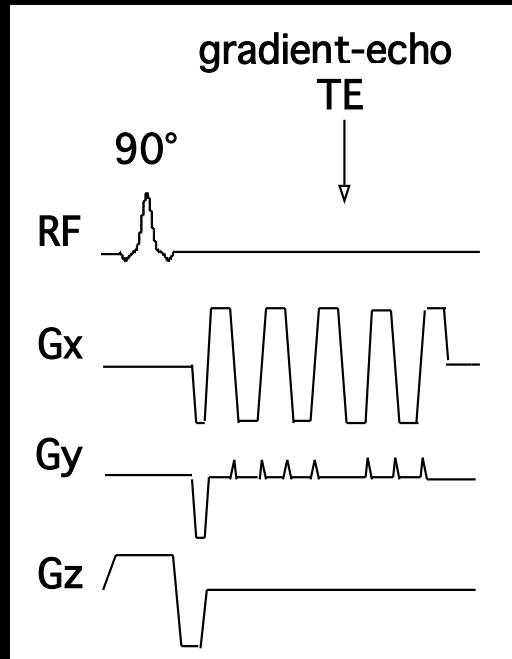

Single Shot Imaging

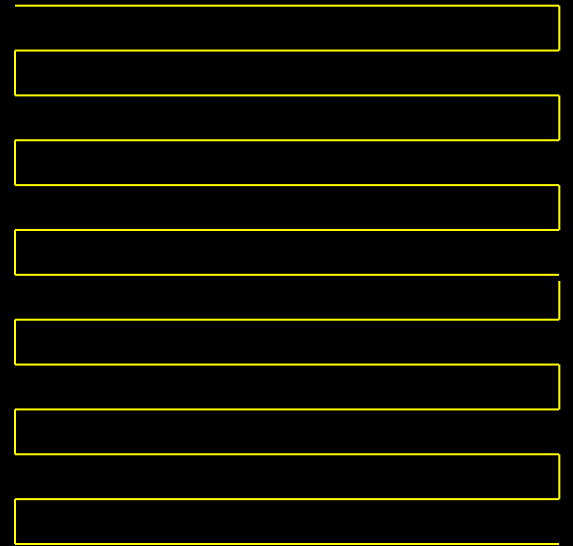
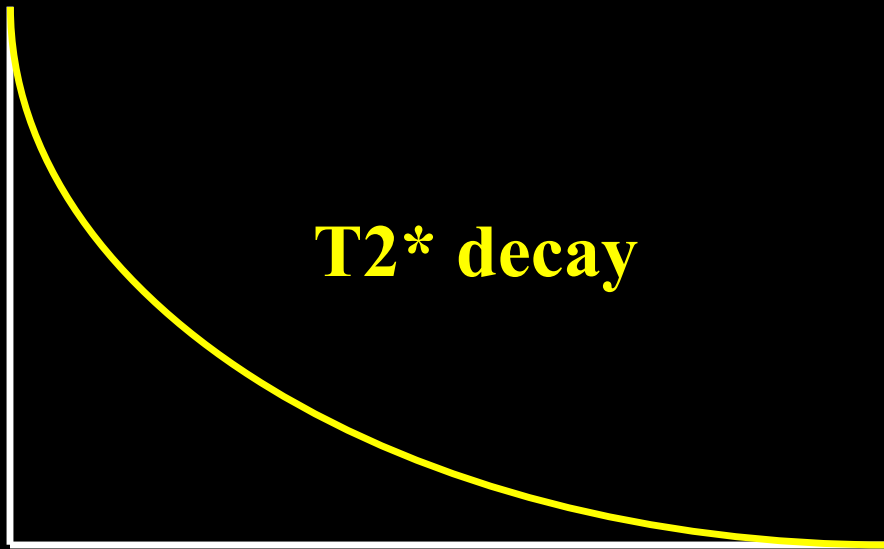

EPI Readout Window

≈ 20 to 40 ms

Imaging System Components

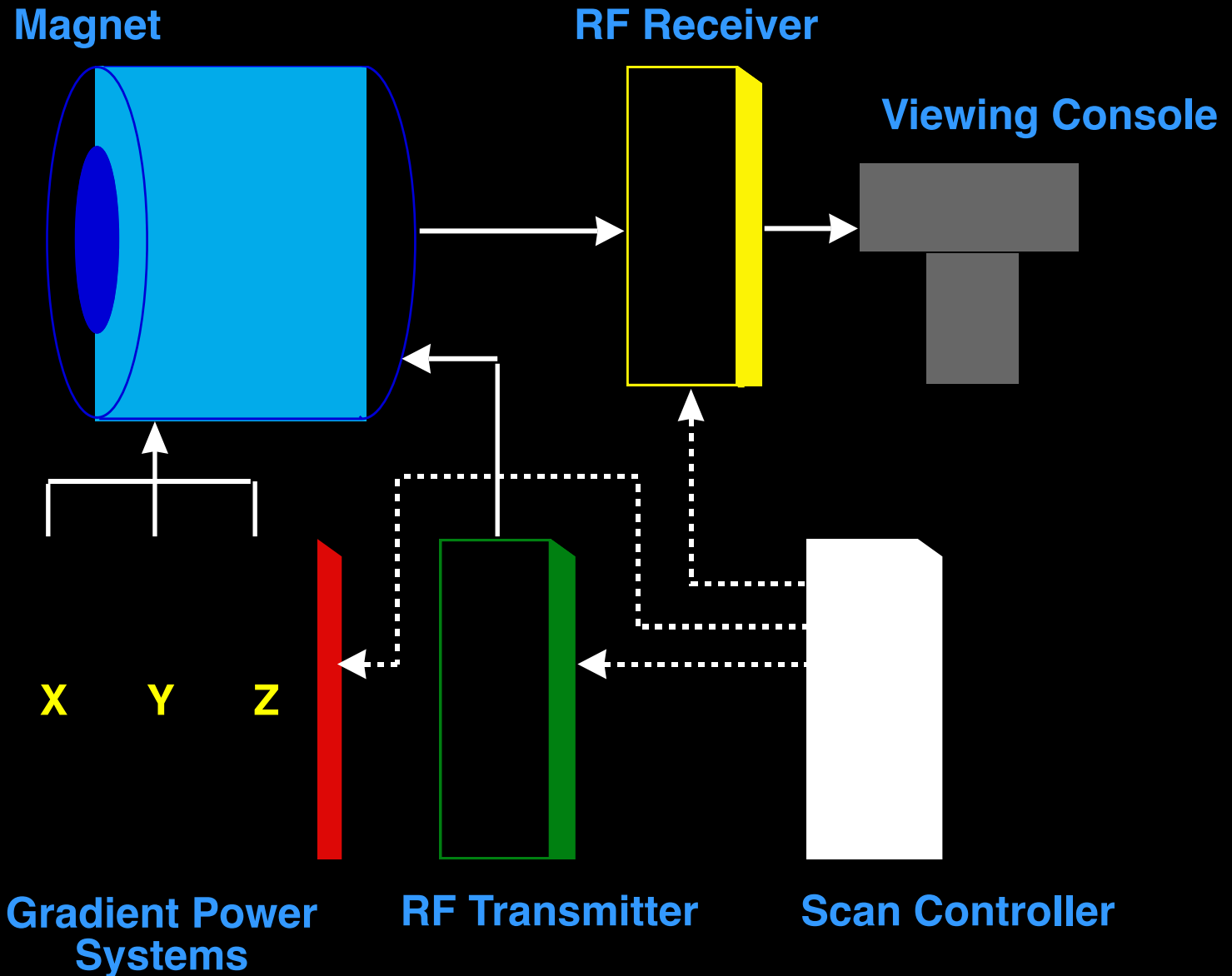

1991-1992



1992-1999



2 G/cm, 350 T/m/s

4 G/cm, 150 T/m/s

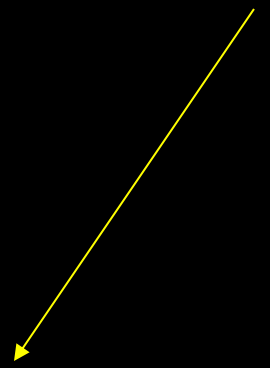
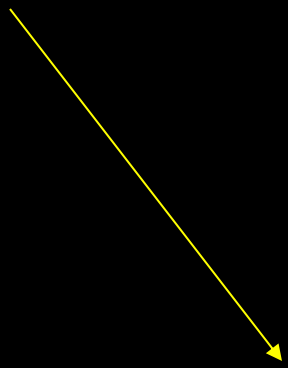
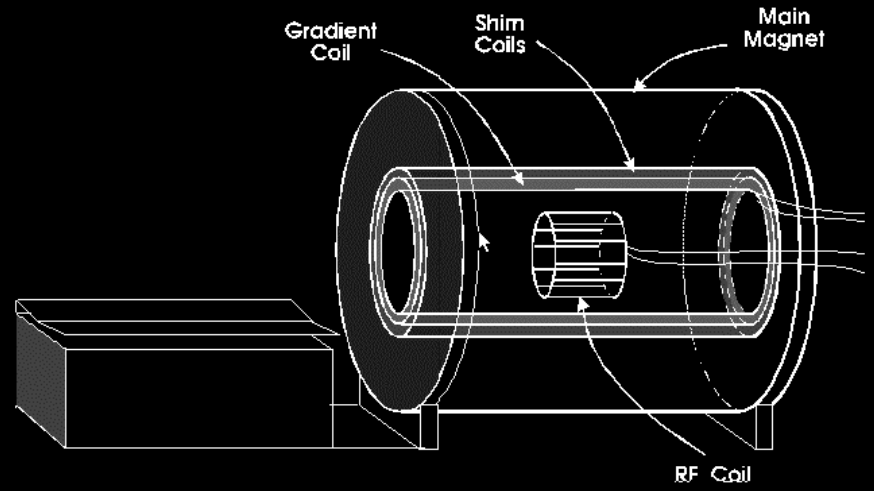

10 G/cm, 1000 T/m/s

The use of fMRI to Investigate Brain Function

Where?

When?

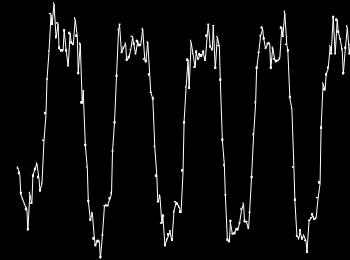
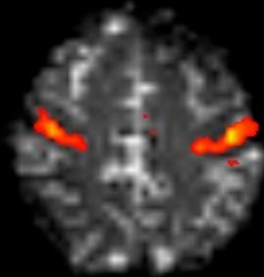

How much?

How to get the brain to do what we want it to do in the context of an fMRI experiment?

A Primary Challenge:

...to make progressively more precise inferences using fMRI without making too many assumptions about non-neuronal physiologic factors.

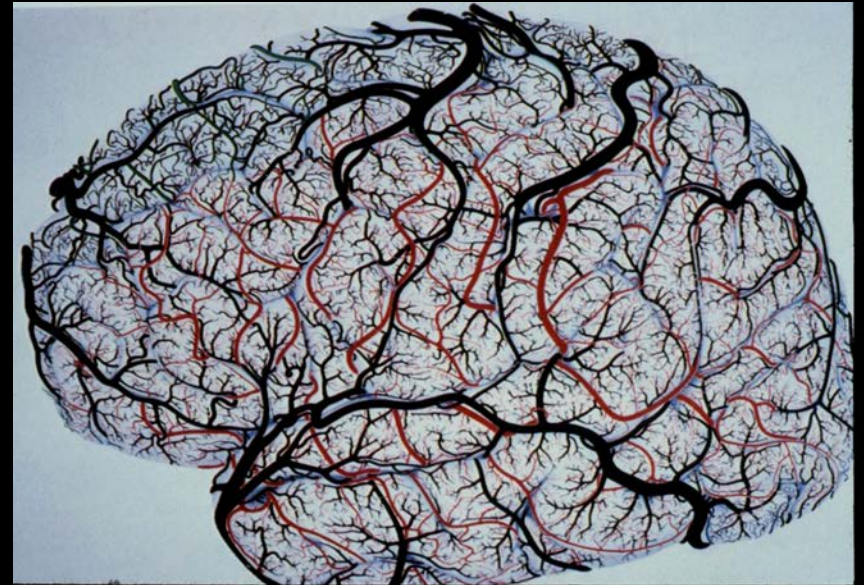
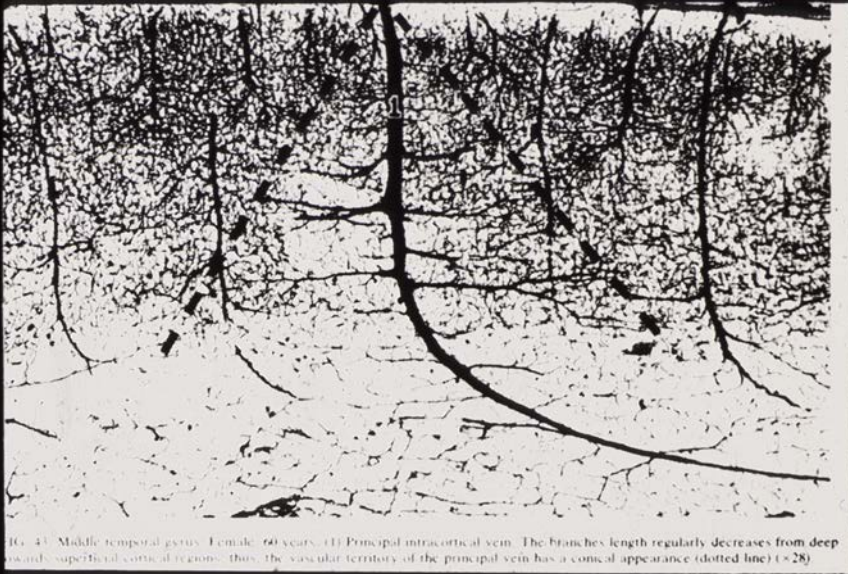

- **Contrast in fMRI**

Hemodynamic Specificity

- **The Hemodynamic Transfer Function**

Location, Latency, Magnitude

- **Best Results So Far**

Temporal Resolution, Spatial Resolution

- **Neuronal Activation Input Strategies**

Block Design

Phase and Frequency Encoding

Orthogonal Designs

Parametric Designs

Event-Related Designs

Free Behavior Designs

- **Contrast in fMRI**

Hemodynamic Specificity

- **The Hemodynamic Transfer Function**

Location, Latency, Magnitude

- **Best Results So Far**

Temporal Resolution, Spatial Resolution

- **Neuronal Activation Input Strategies**

Block Design

Phase and Frequency Encoding

Orthogonal Designs

Parametric Designs

Event-Related Designs

Free Behavior Designs

Contrast in Functional MRI

- **Blood Volume**

- Contrast agent injection and time series collection of T2* or T2 - weighted images

- **BOLD**

- Time series collection of T2* or T2 - weighted images

- **Perfusion**

- T1 weighting
- Arterial spin labeling

- **CMRO₂**

- BOLD and Perfusion w/
Normalization to Global Perfusion Change

Resting

Active

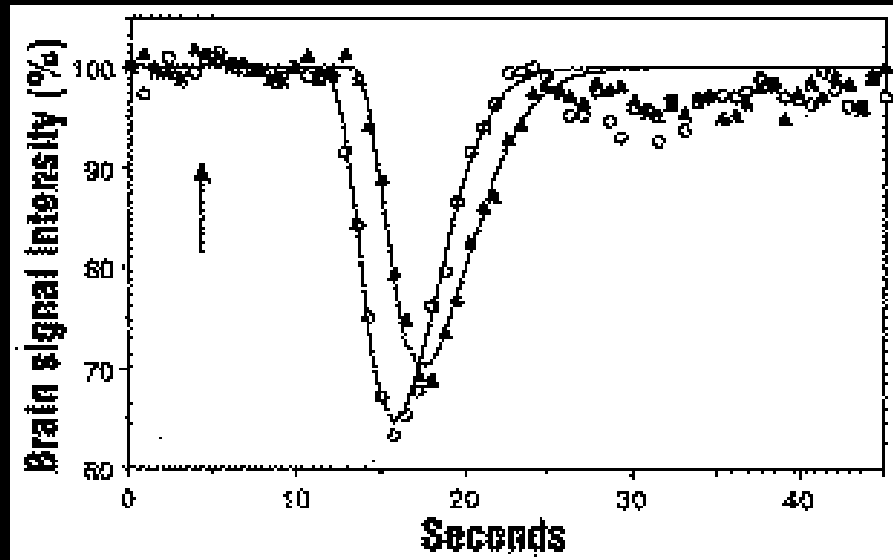
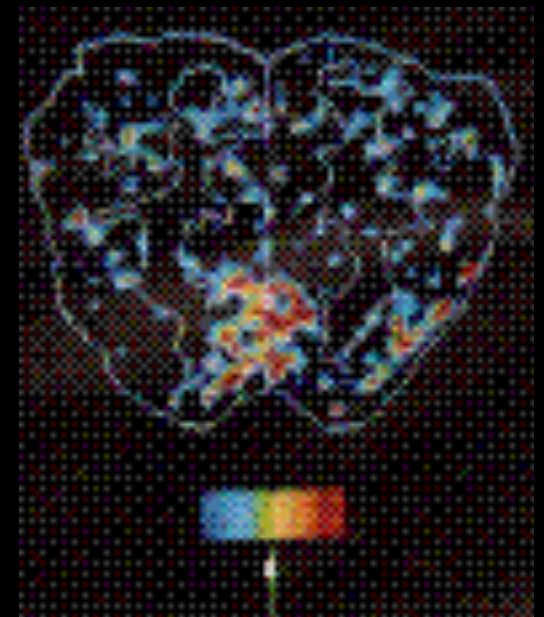
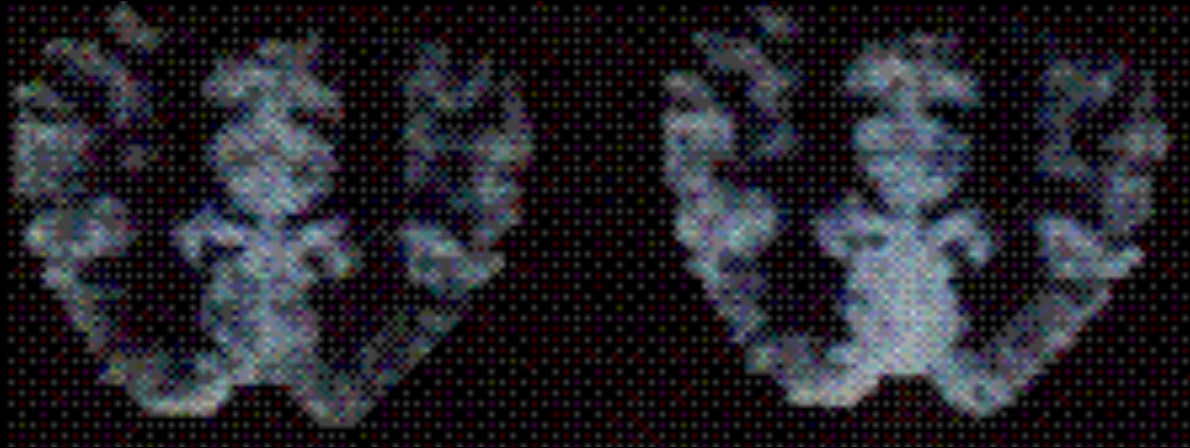

Photic Stimulation

MRI Image showing
activation of the
Visual Cortex

From Belliveau, et al.
Science Nov 1991

MSC - perfusion

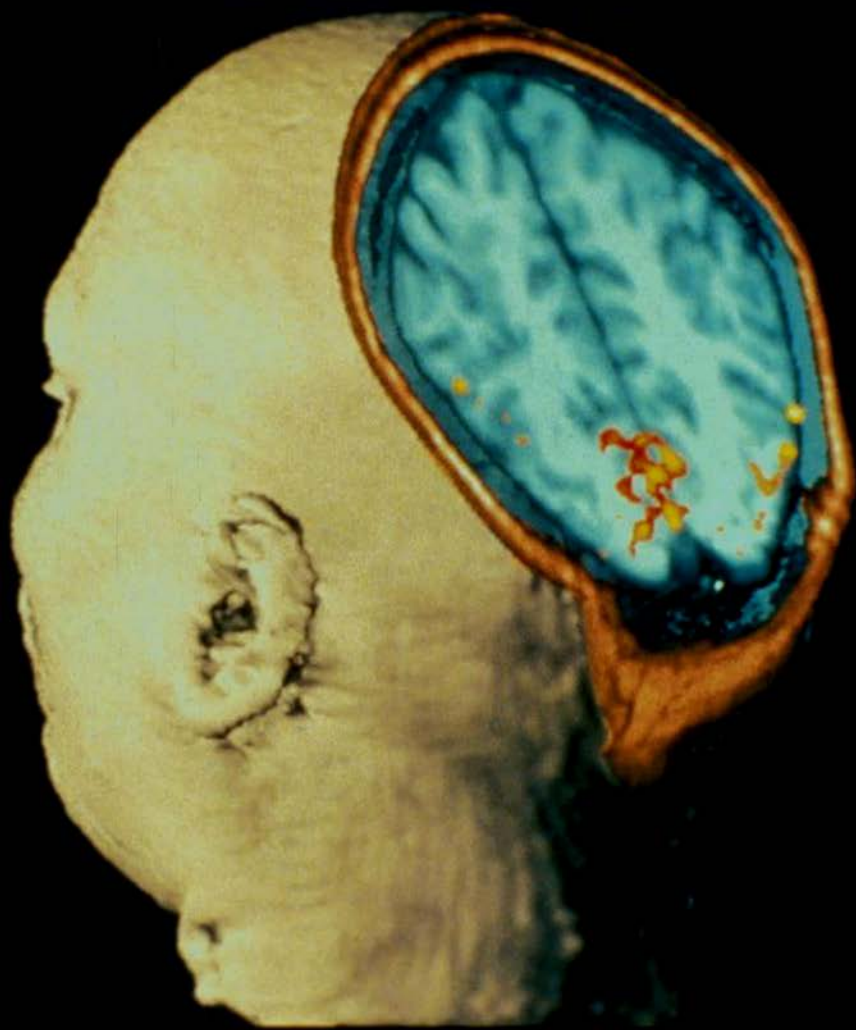

Susceptibility-Induced Field Distortion in the
Vicinity of a Microvessel \perp to B_0 .

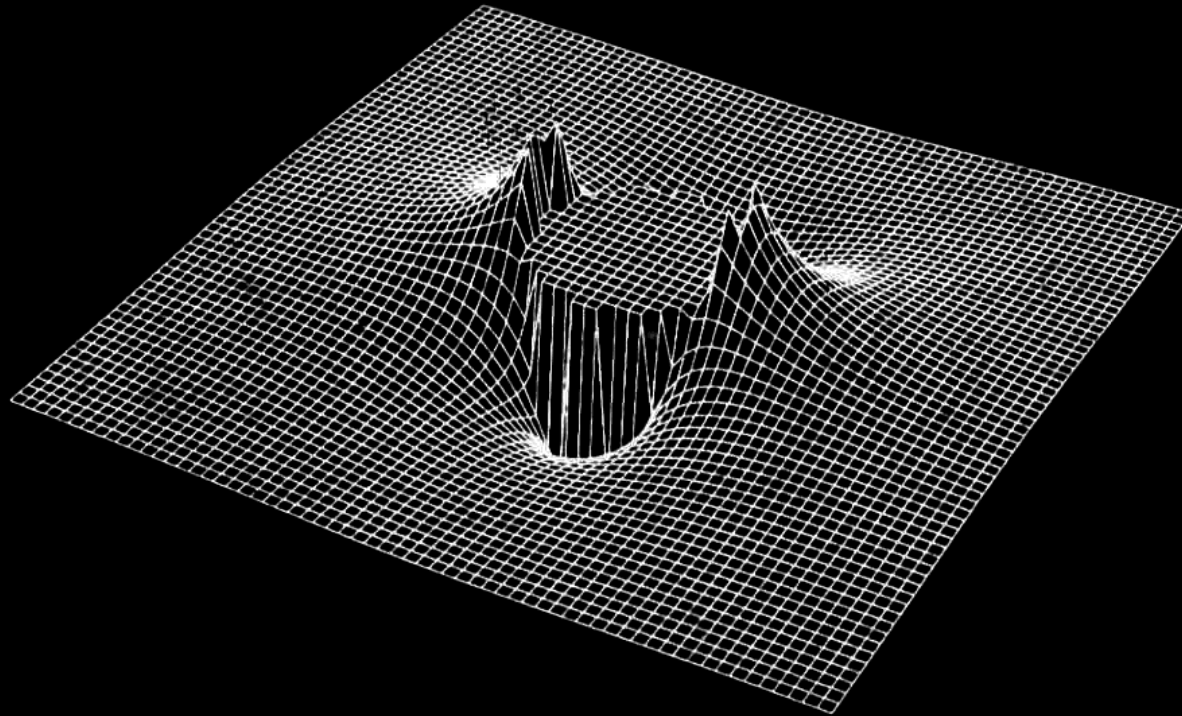

BOLD Contrast in the Detection of Neuronal Activity

Cerebral Tissue Activation



Local Vasodilation



Increase in Cerebral Blood Flow and Volume



Oxygen Delivery Exceeds Metabolic Need



Increase in Capillary and Venous Blood Oxygenation



Decrease in Deoxy-hemoglobin

Deoxy-hemoglobin: paramagnetic
Oxy-hemoglobin: diamagnetic



Decrease in susceptibility-related intravoxel dephasing



Increase in T2 and T2*



Local Signal Increase in T2 and T2* - weighted sequences

The BOLD Signal

Blood Oxygenation Level Dependent (BOLD) signal changes

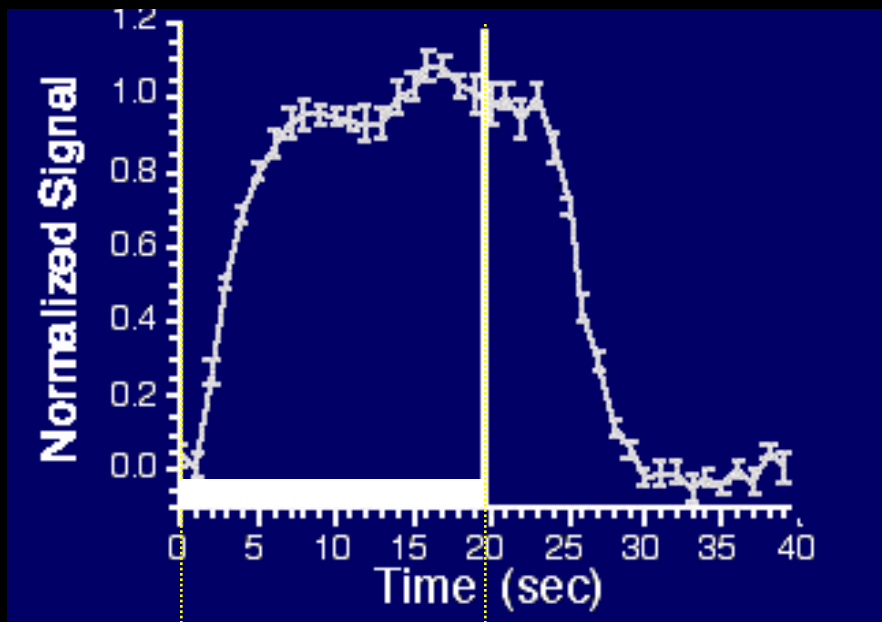

task

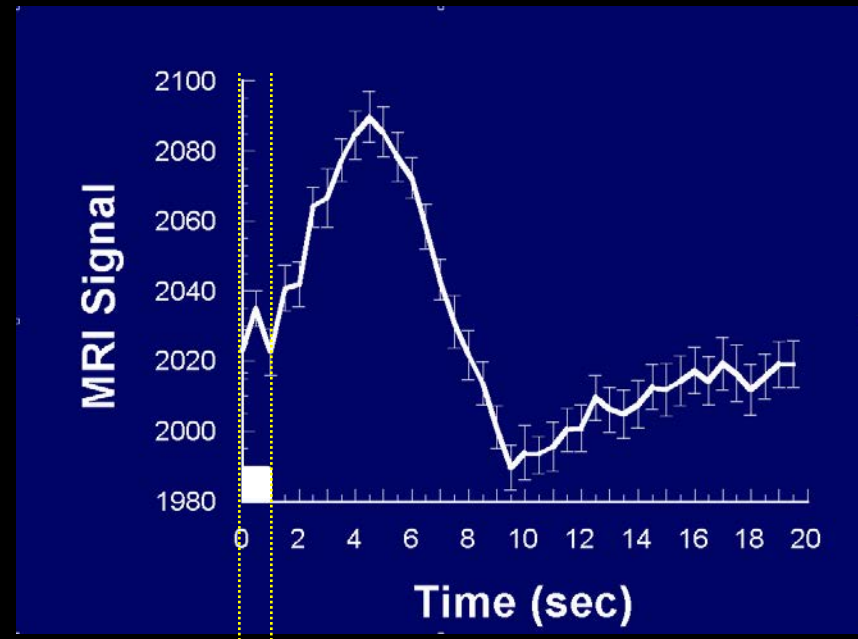

task

Alternating Left and Right Finger Tapping



~ 1992

Creating a Functional Image

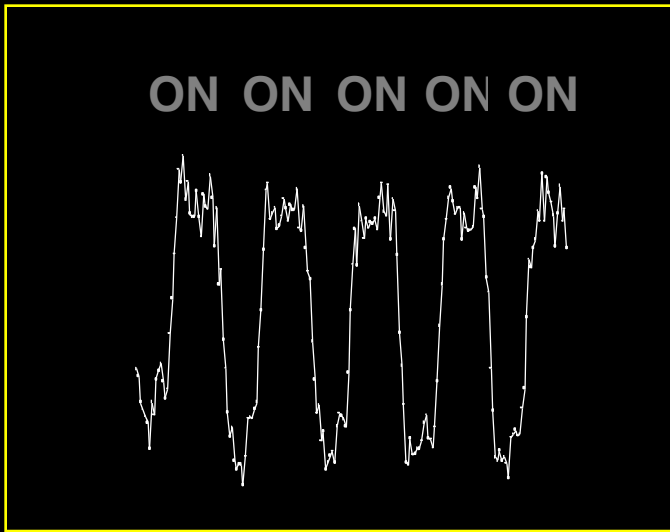

Signal Time Course

X

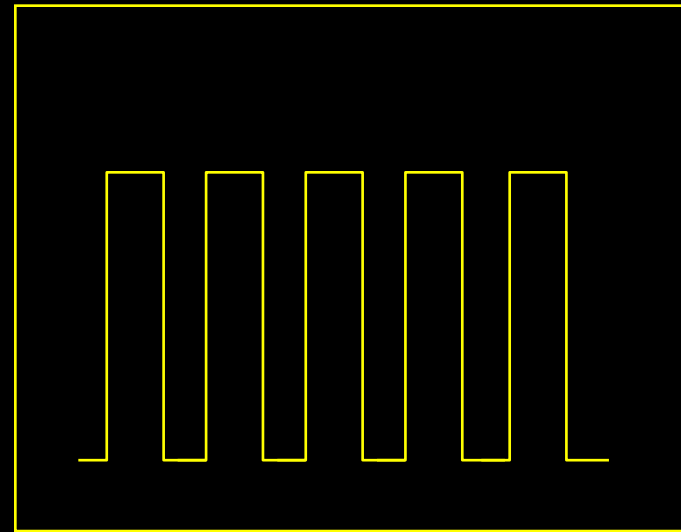

Reference Function

=





Cross Correlation Image

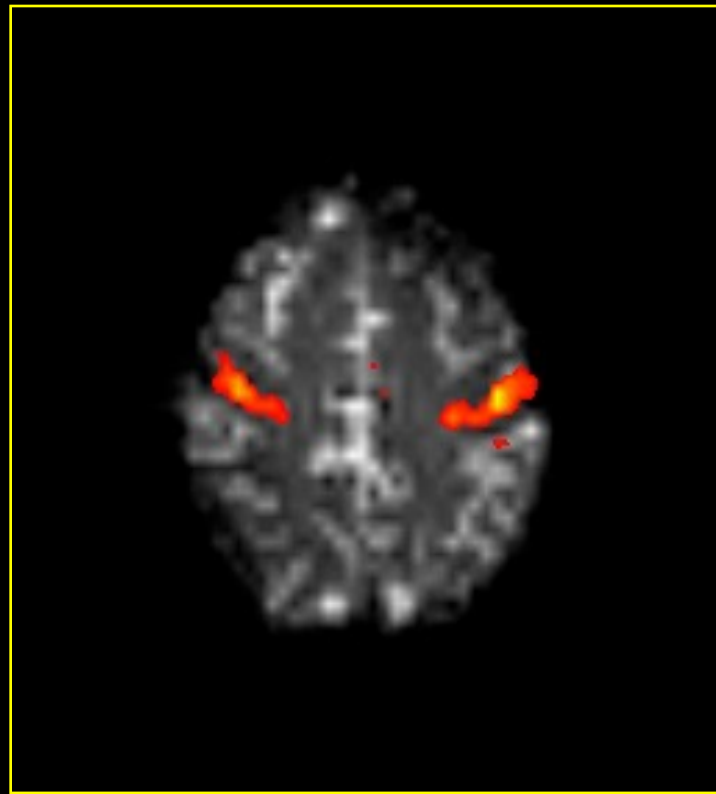

Cross Correlation Image
Anatomical Image



Perfusion / Flow Imaging

EPISTAR

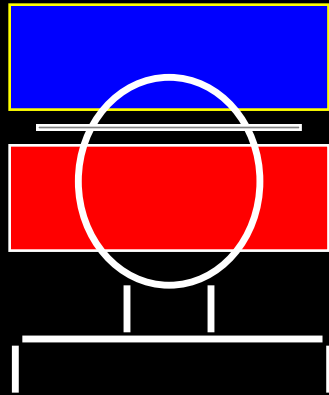

FAIR

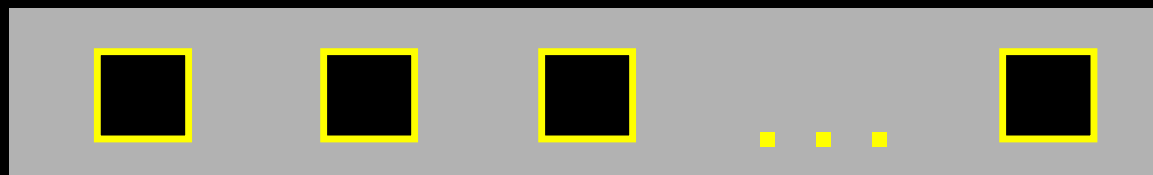
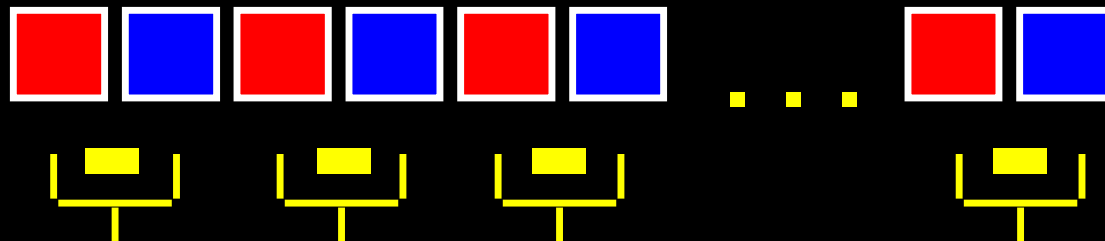
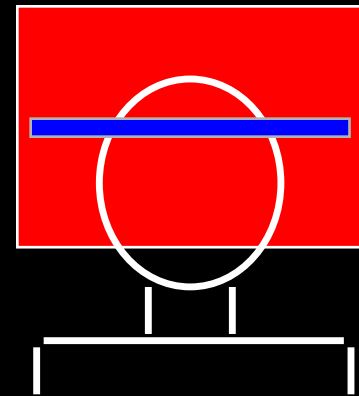

**Perfusion
Time Series**

TI (ms)

FAIR

EPISTAR

200

400

600

800

1000

1200

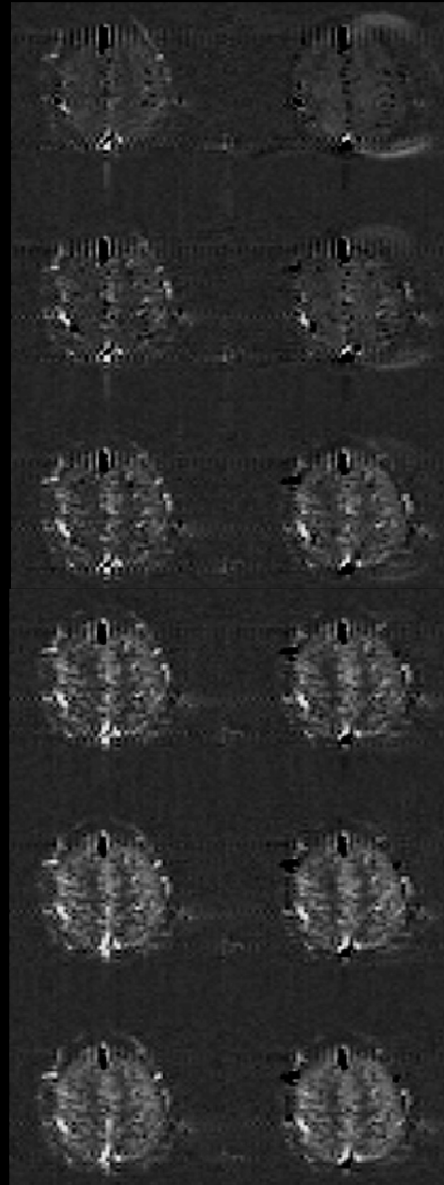

Resting ASL Signal

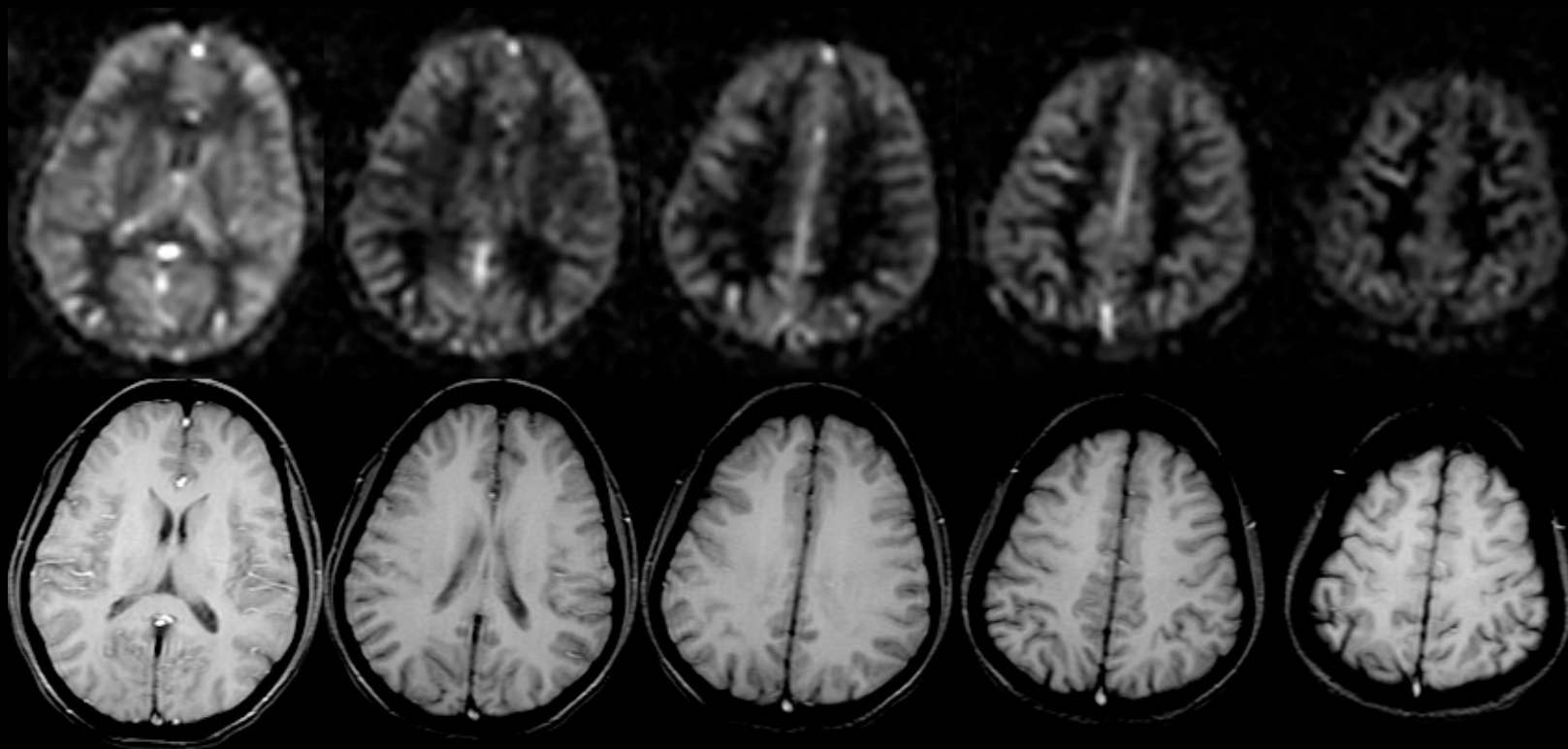

Comparison with Positron Emission Tomography

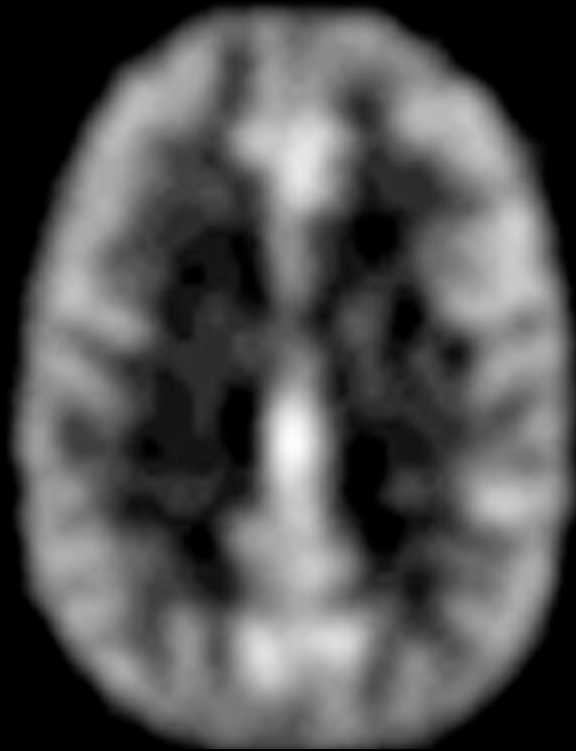

PET: H_2^{15}O

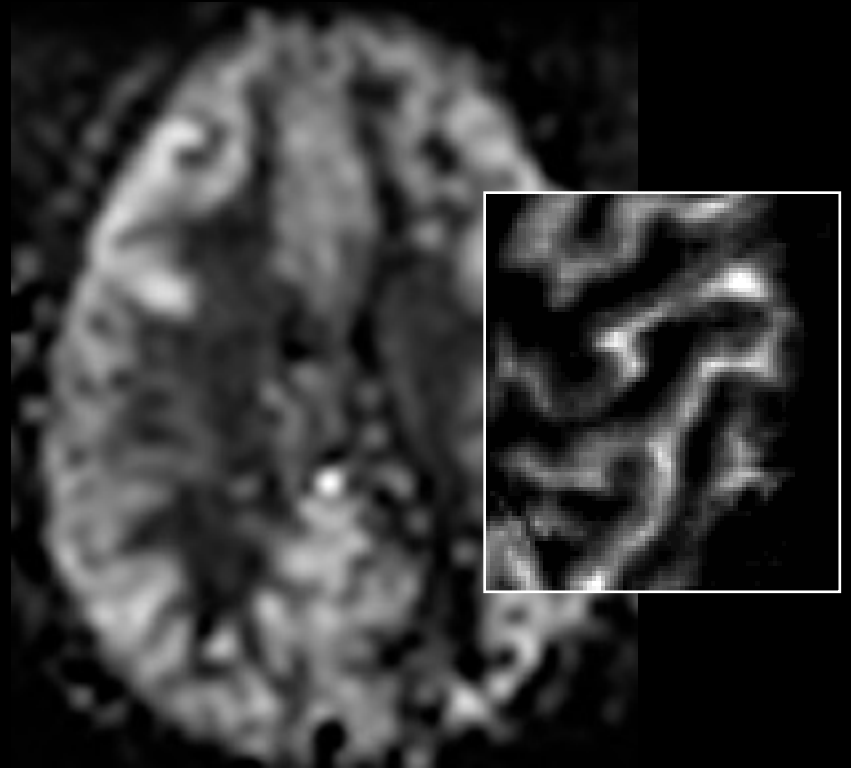

MRI: ASL

Perfusion

BOLD

Rest

Activation

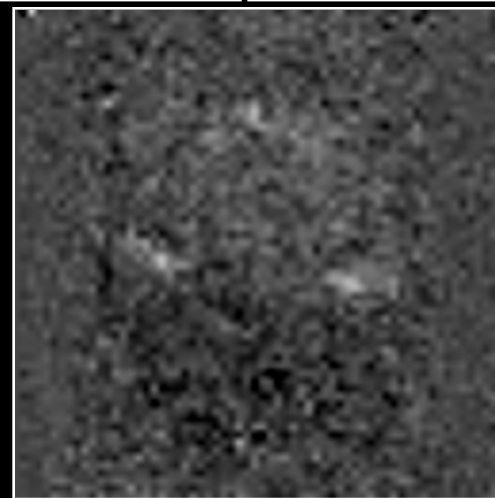
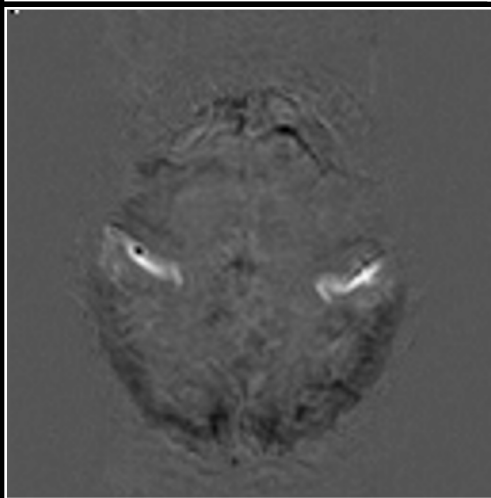
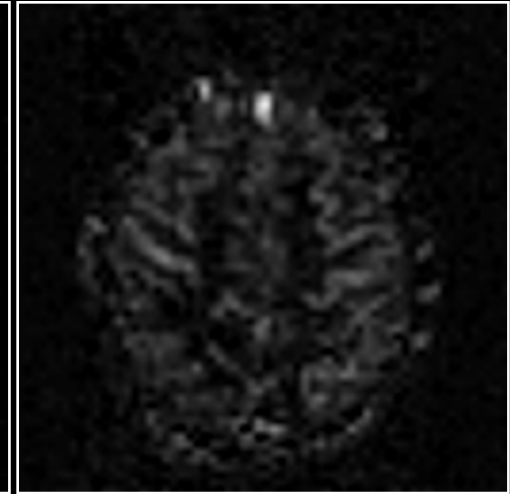
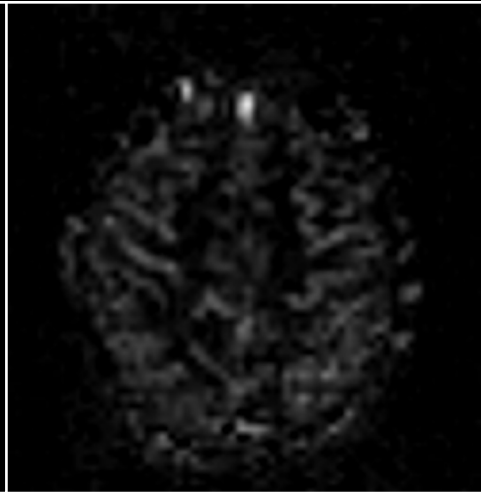
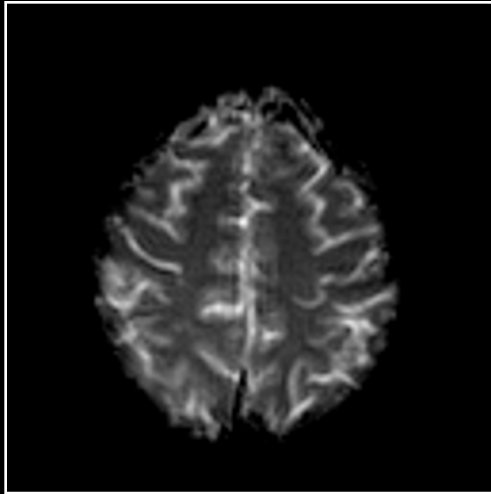

Anatomy



BOLD



Perfusion



Hemodynamic Specificity

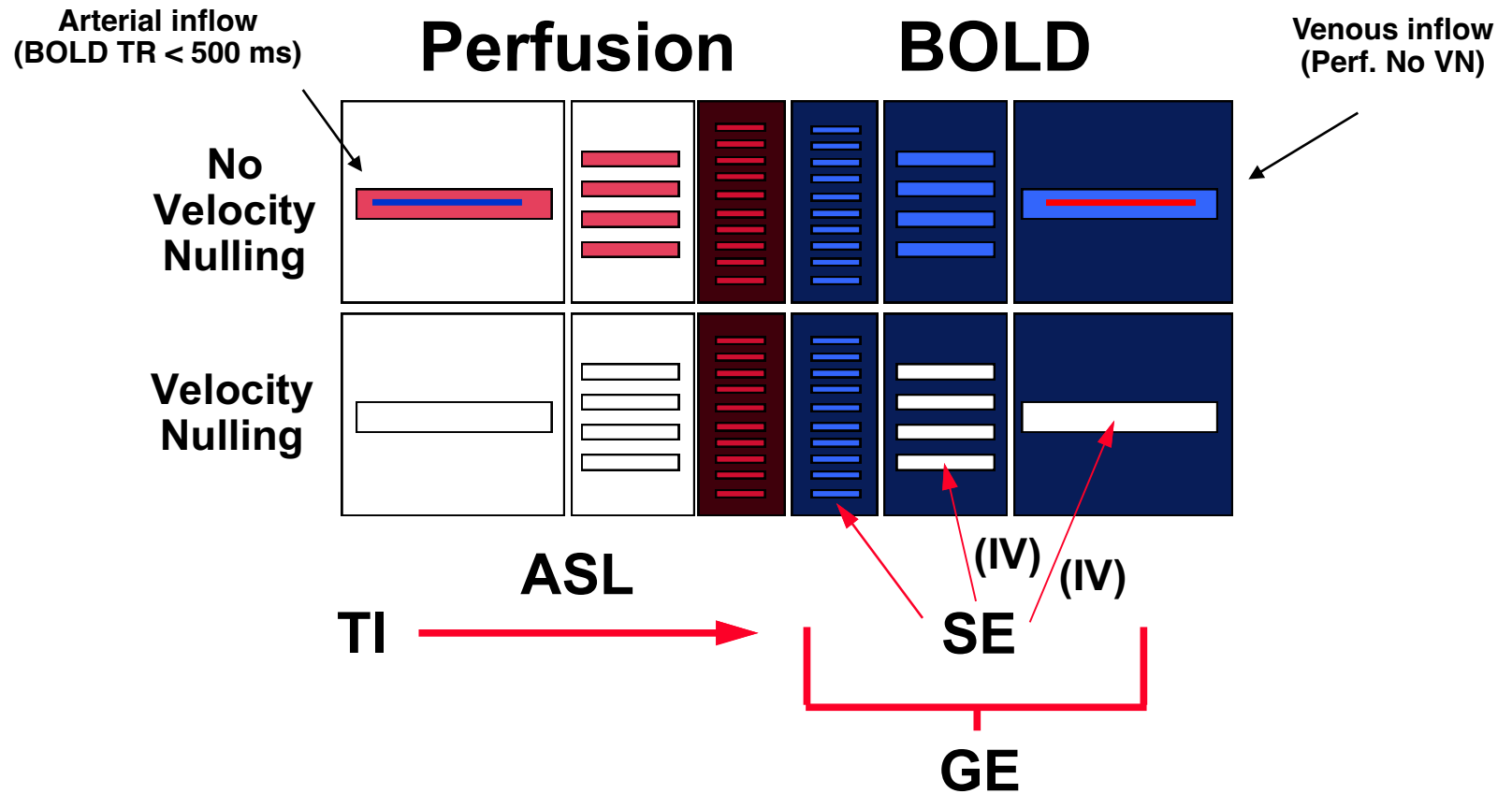

Hemodynamic Stress Calibration

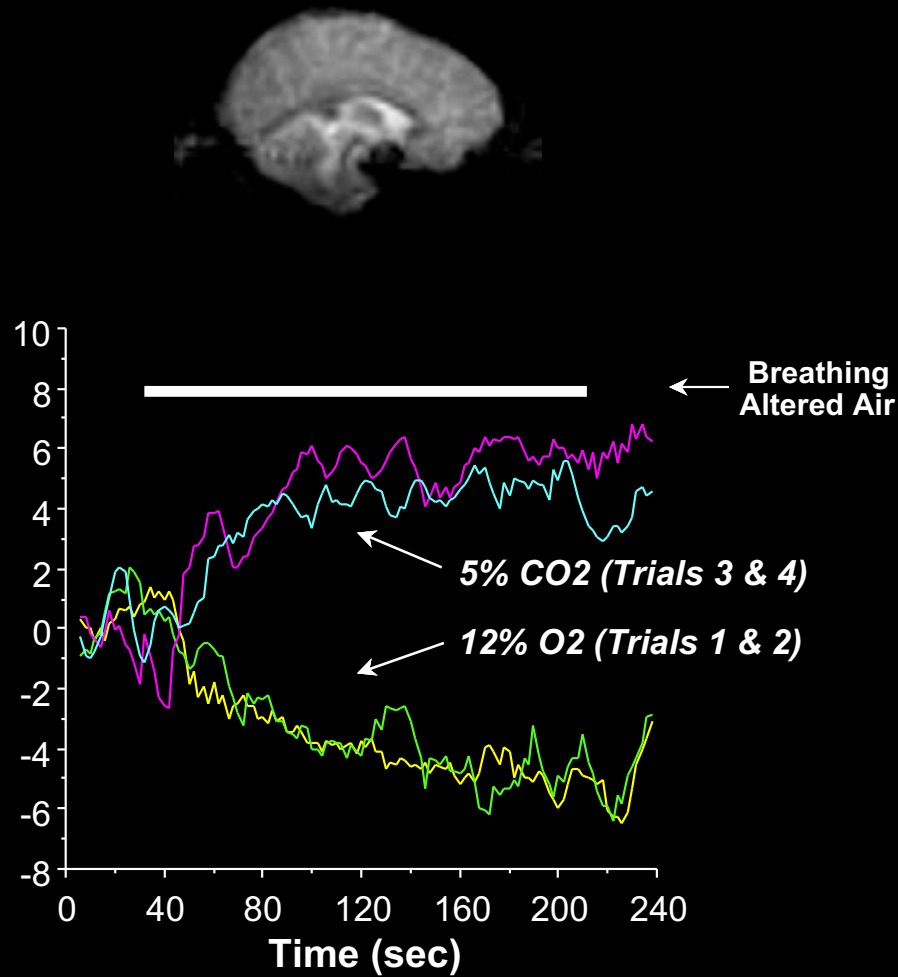

5% CO2

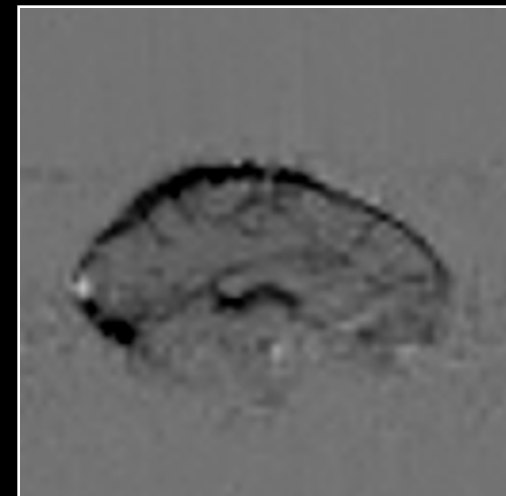
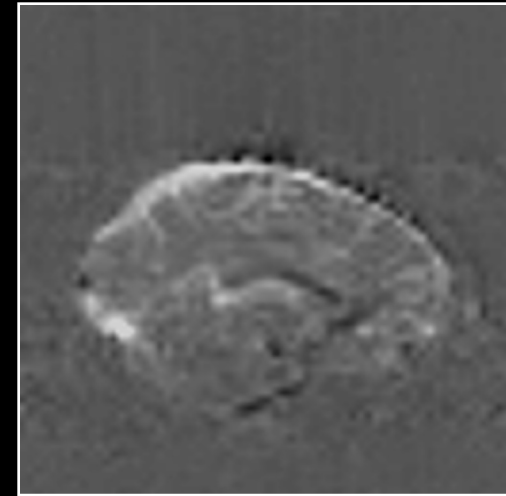

12% O2

CMRO₂-related BOLD signal deficit:

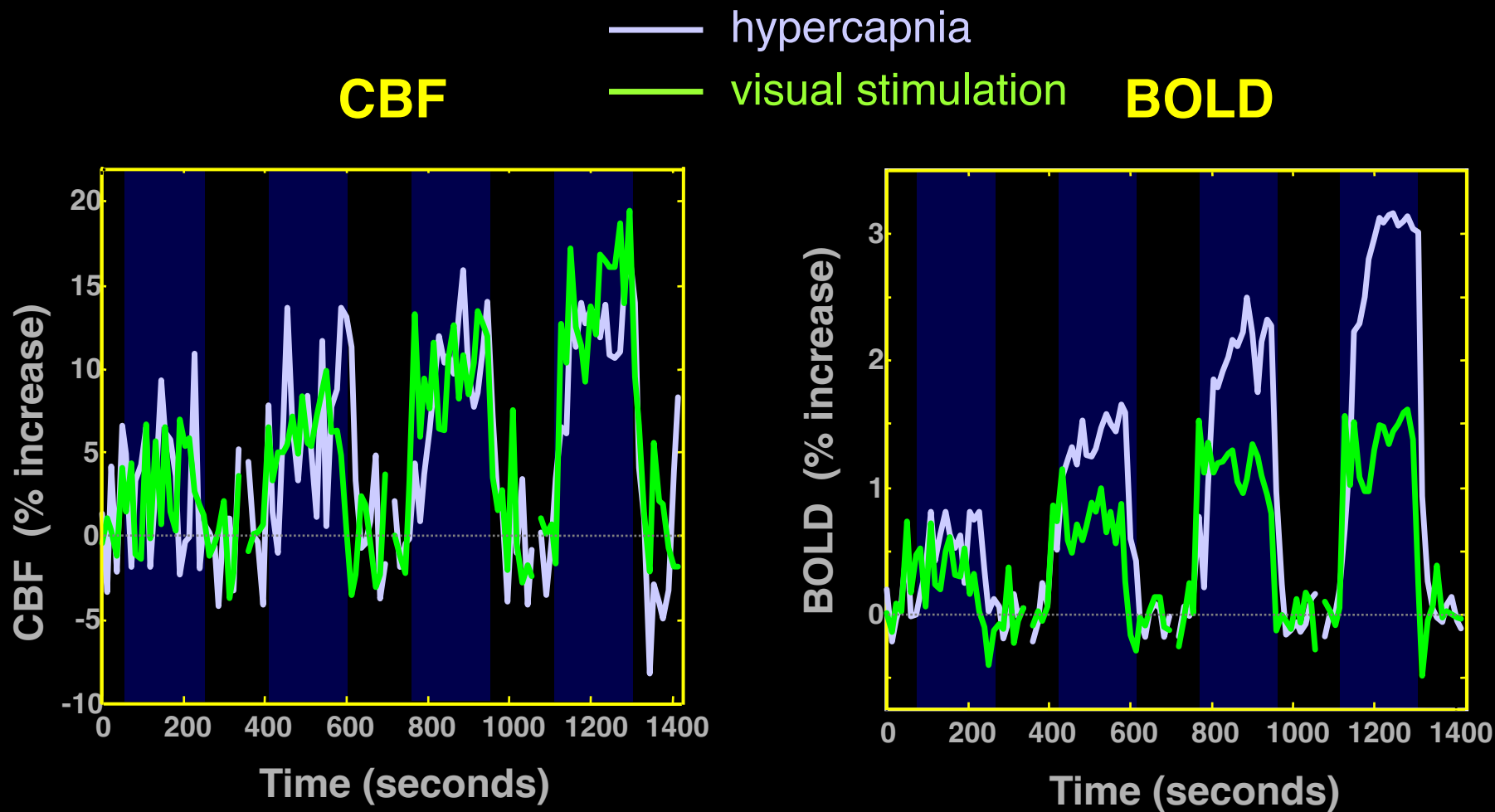

Simultaneous Perfusion and BOLD imaging during graded visual activation and hypercapnia

CBF-CMRO₂ coupling

Hoge, et al.

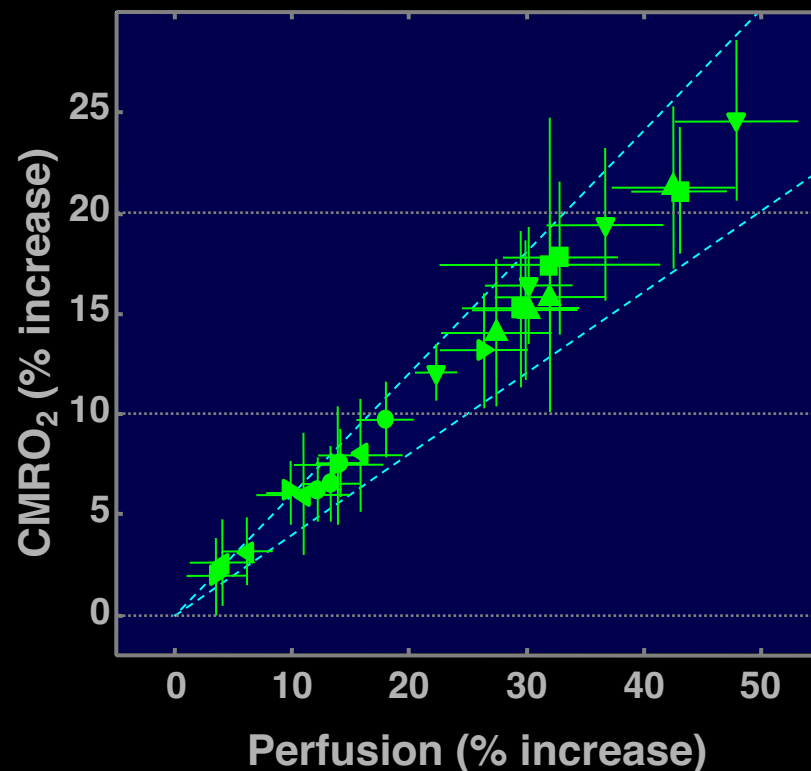
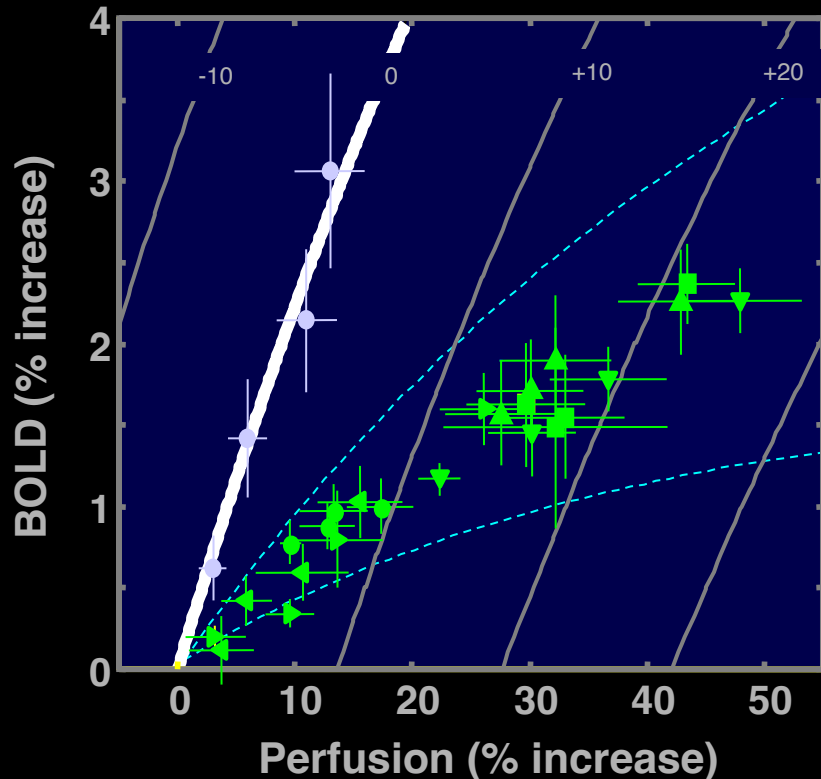

Characterizing Activation-induced CMRO₂ changes using calibration with hypercapnia

Computed CMRO₂ changes

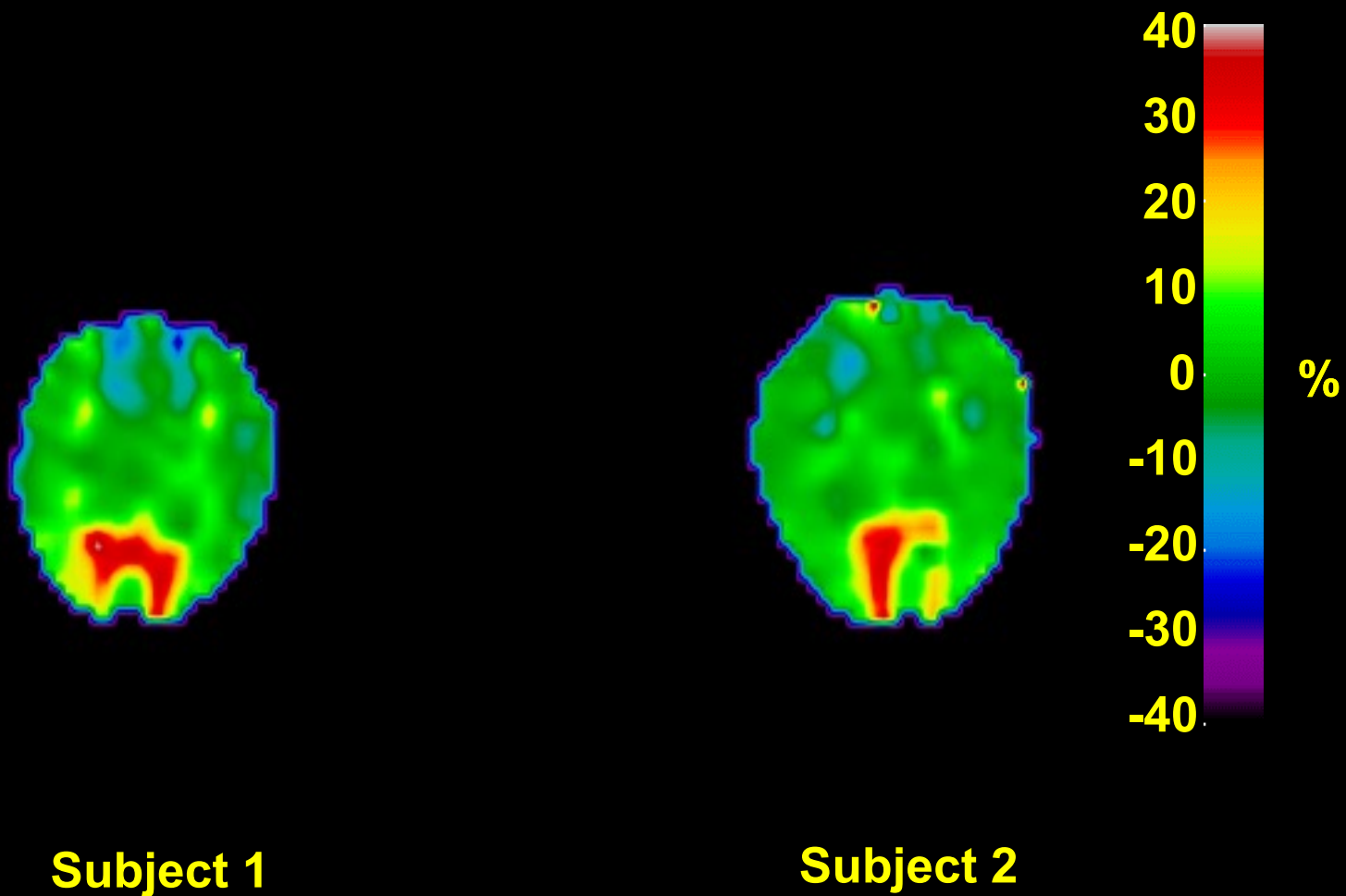

Quantitative Measurements of Cerebral Metabolic Rate of Oxygen (CMRO₂) Using MRI: A Volunteer Study

Hongyu AN¹, Weili LIN², Azim CELIK³, Yueh Z. LEE⁴

¹Washington University, 600 Airport Road, Chapel Hill, NC USA; ²UNC-Chapel Hill, Department of Radiology, CB#7515, Chapel Hill, NC USA; ³GE Medical Systems; ⁴UNC-Chapel Hill;

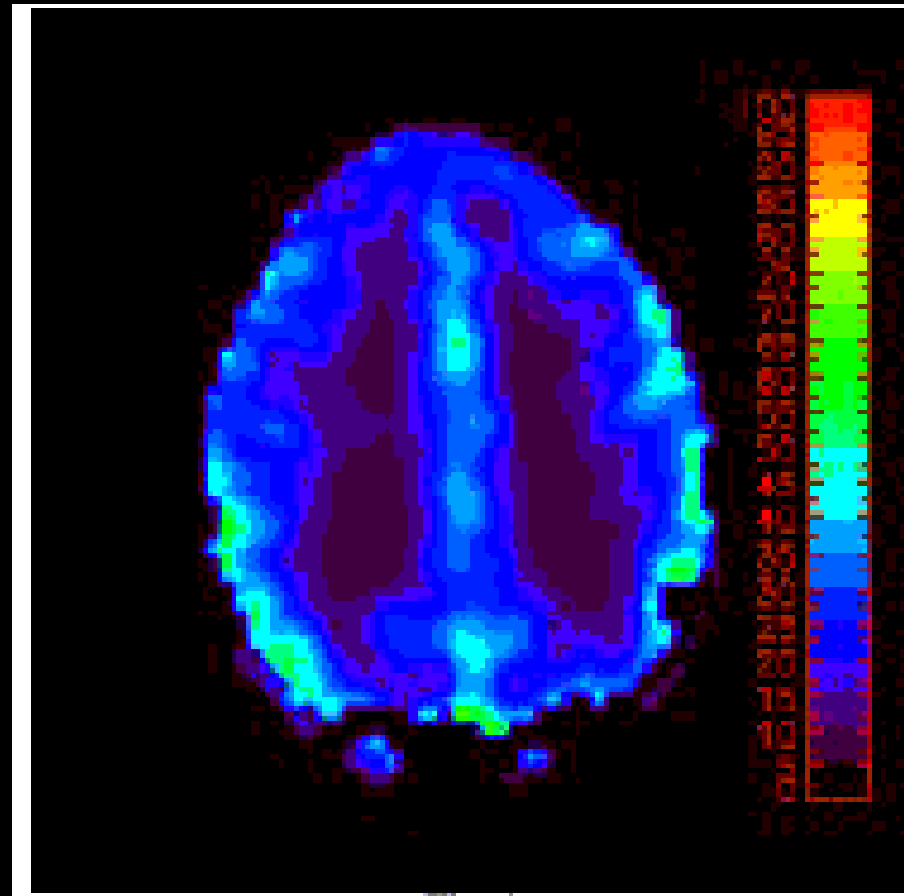
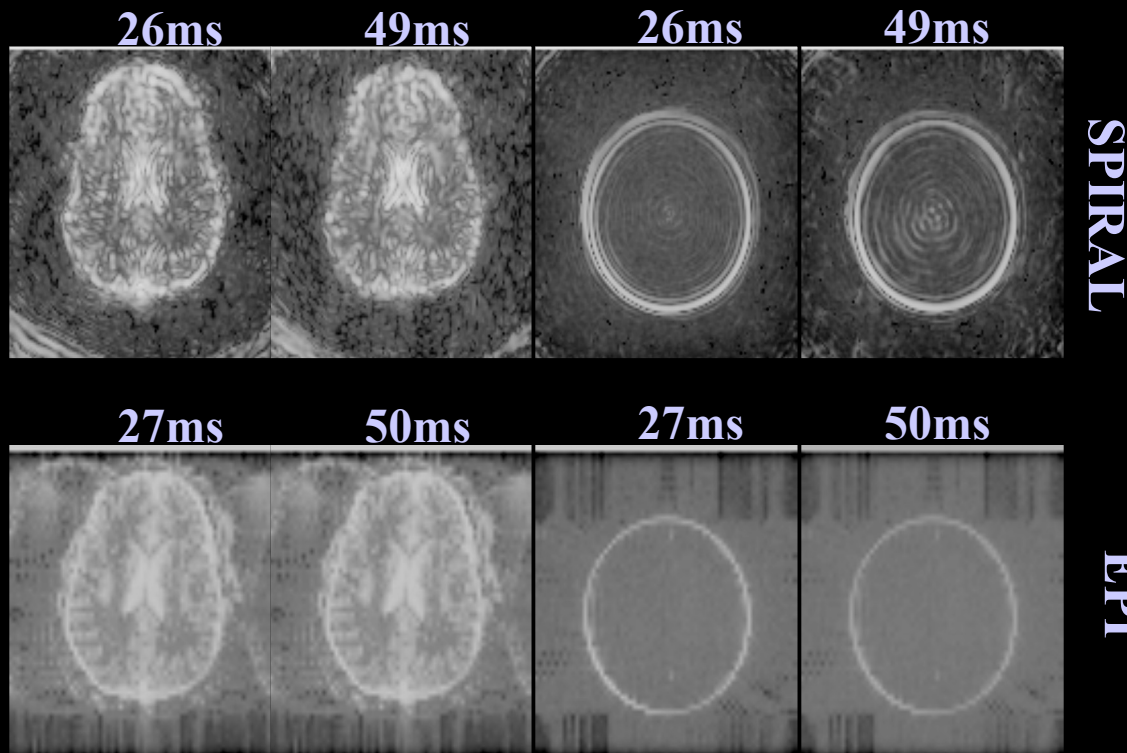

Figure 1

Higher Signal to Noise **in a single image** does not necessarily translate to higher Signal to Noise **over time**.

Temporal vs. Spatial SNR- 3T



0.25 Hz Breathing at 3T

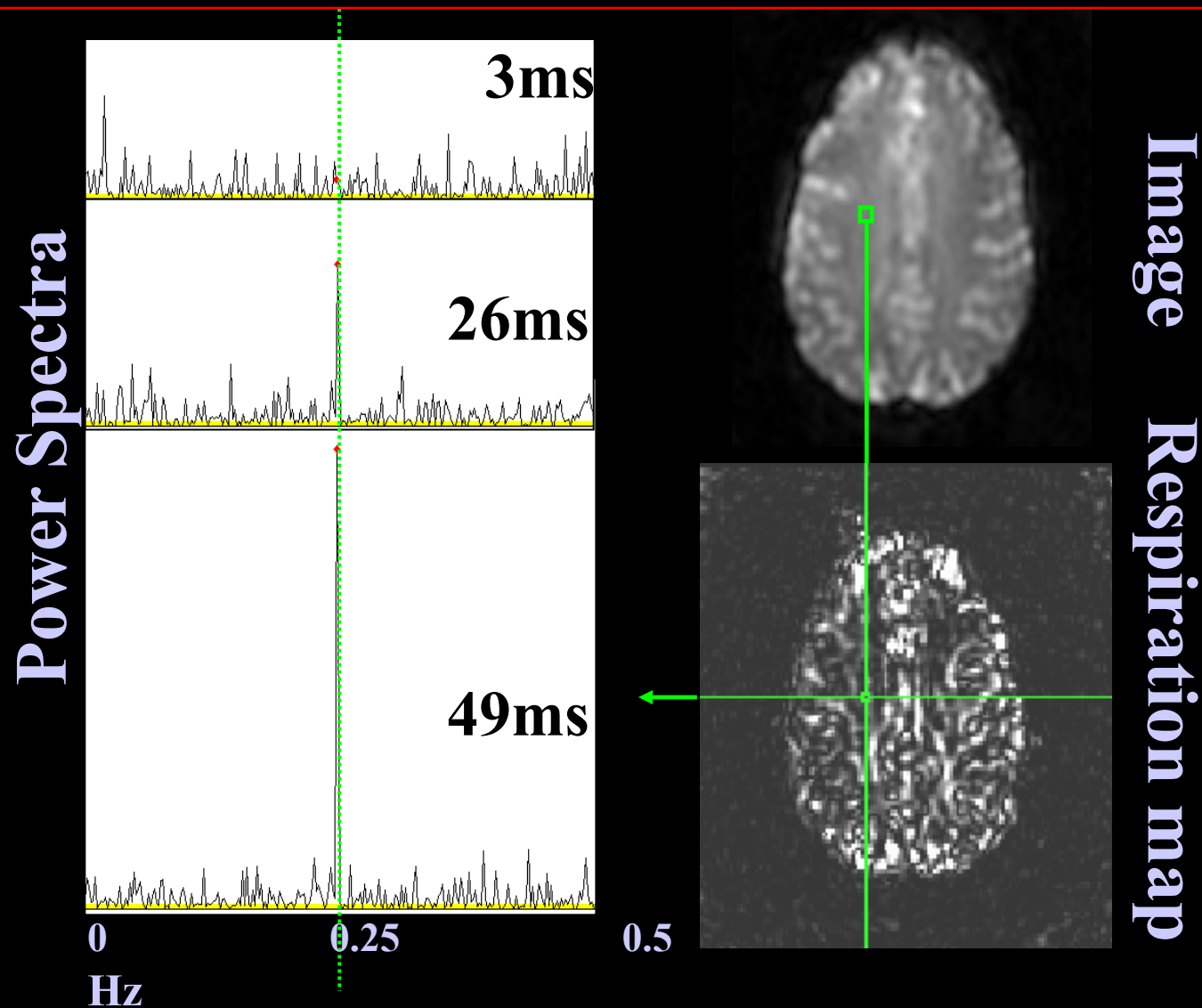

0.68 Hz Cardiac rate at 3T

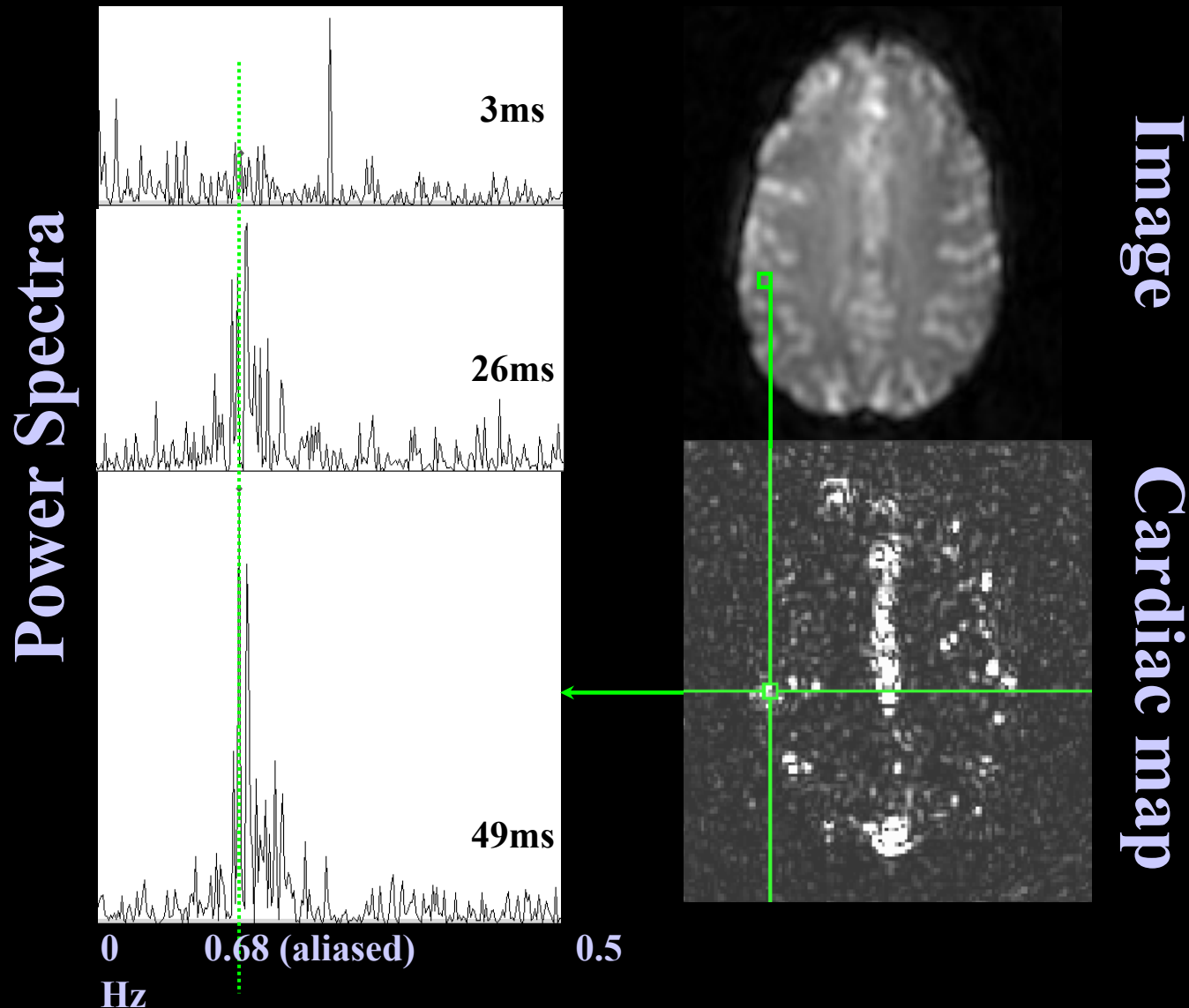

Temporal S/N vs. Image S/N

PHANTOMS

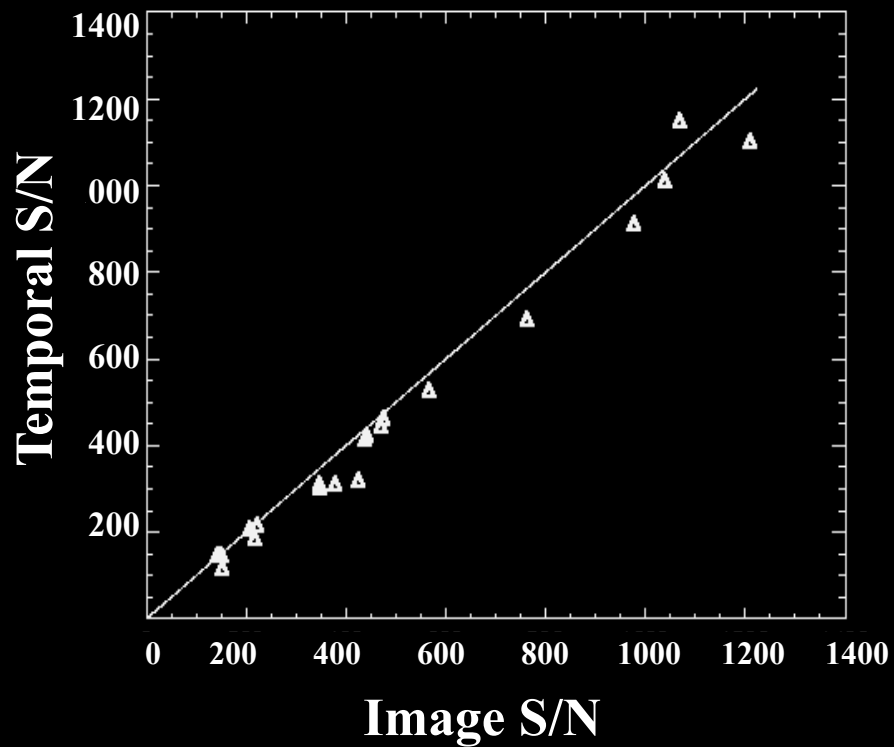

SUBJECTS

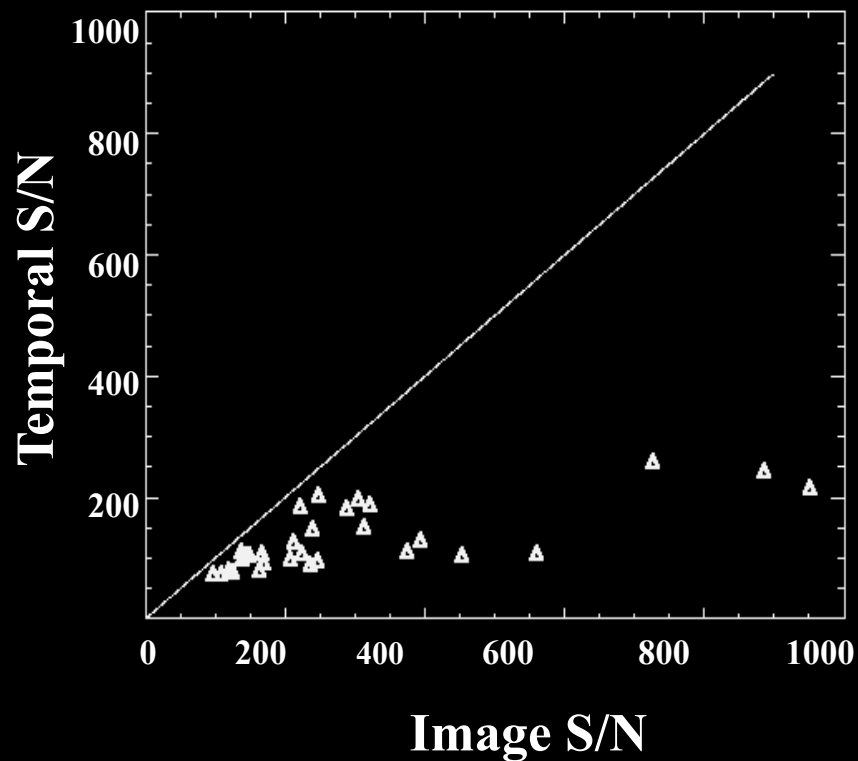

Fit curve: Pos: $22.3478 \text{ Nrep} + 373.782$ --- Neg: $11.6126 \text{ Nrep} + 30.8055$
Fit corr. coeff. (pos, neg) : (0.948073, 0.989839).
Red→pos., Green→neg.

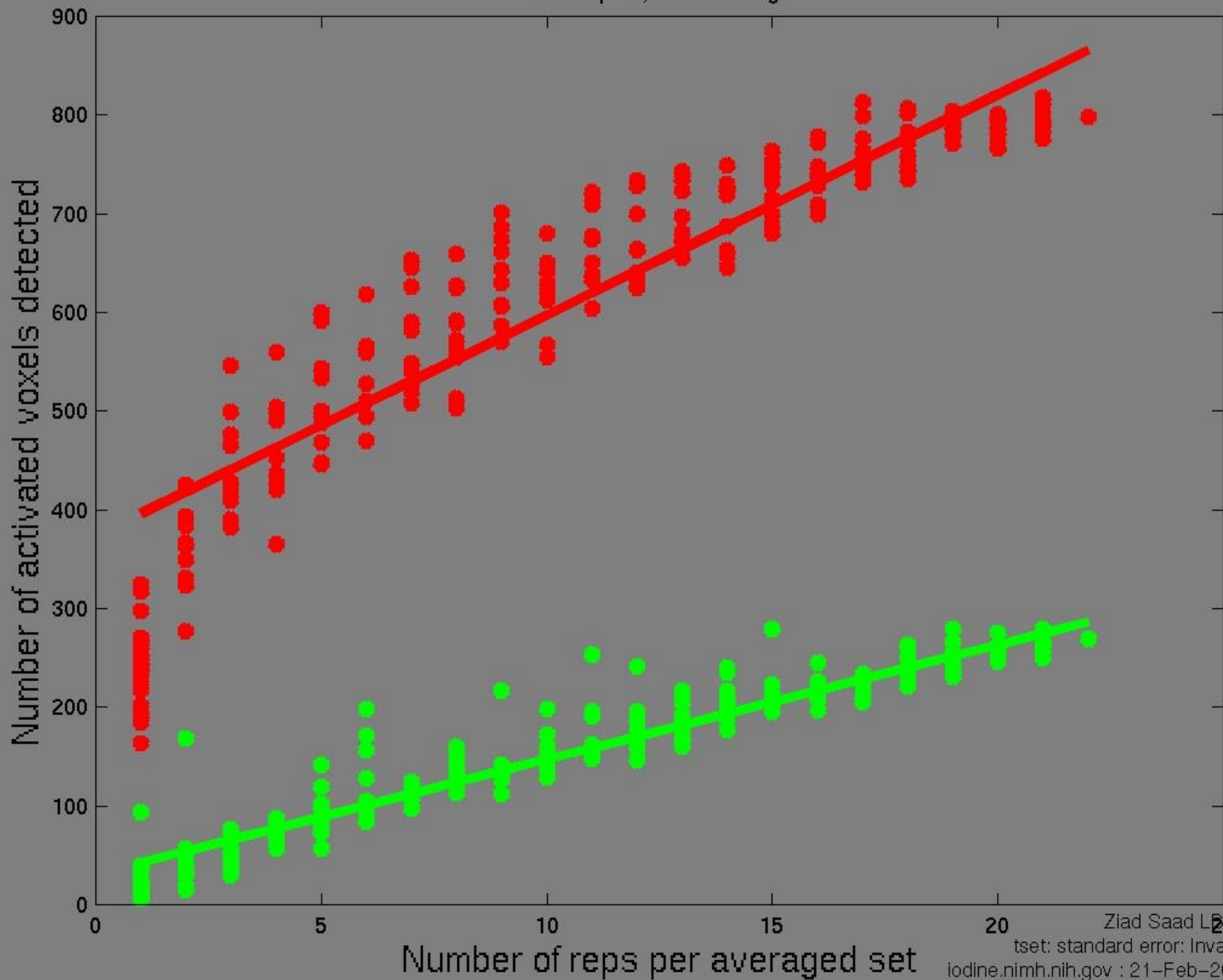

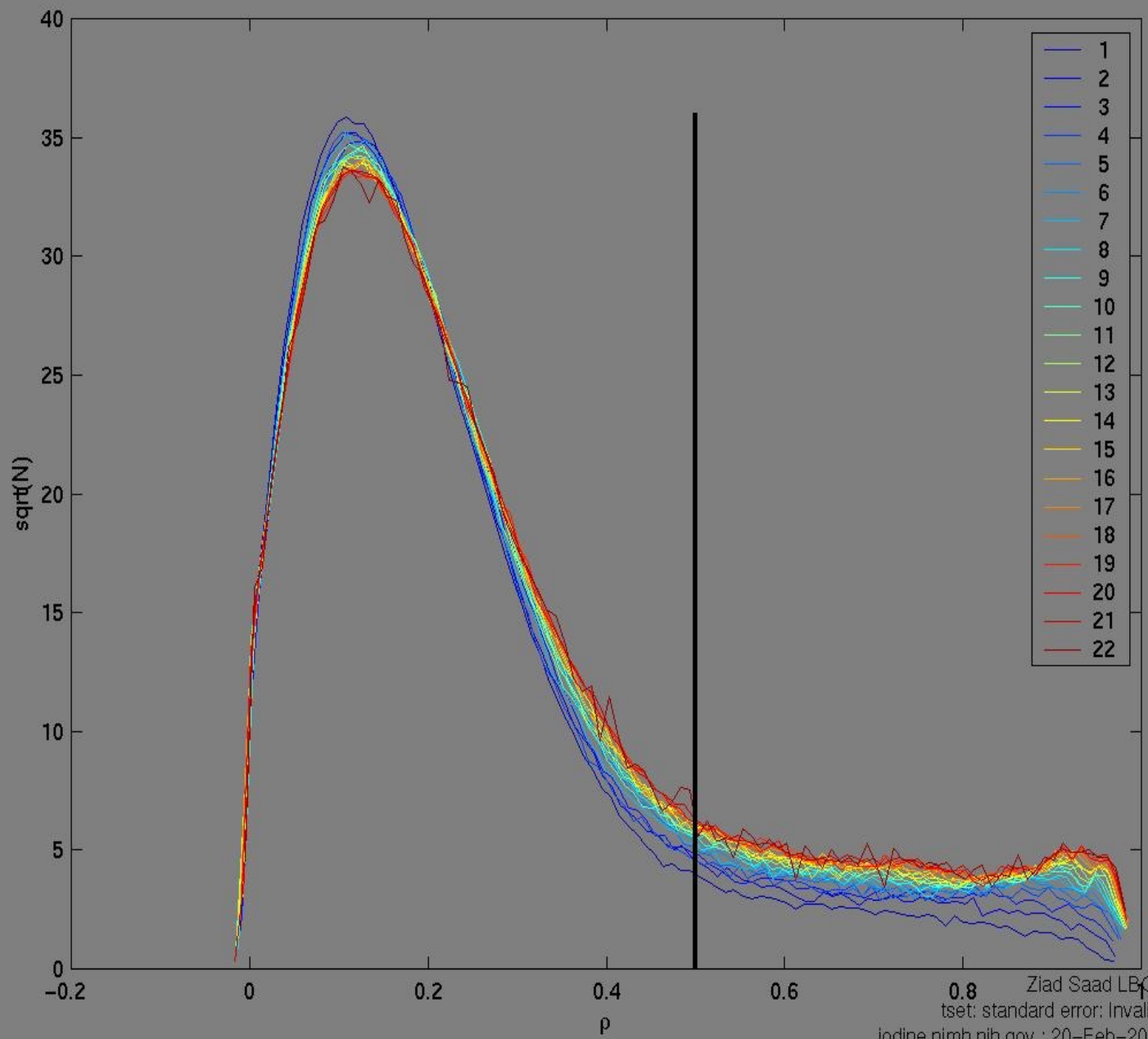

- Contrast in fMRI

Hemodynamic Specificity

- **The Hemodynamic Transfer Function**

Location, Latency, Magnitude, Linearity

- Best Results So Far

Temporal Resolution, Spatial Resolution

- Neuronal Activation Input Strategies

Block Design

Phase and Frequency Encoding

Orthogonal Designs

Parametric Designs

Event-Related Designs

Free Behavior Designs

Hemodynamic Transfer Function

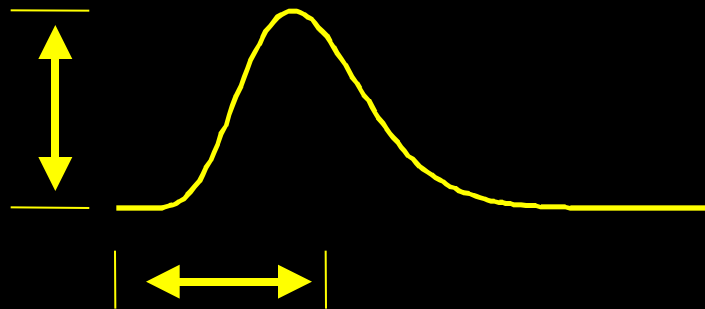
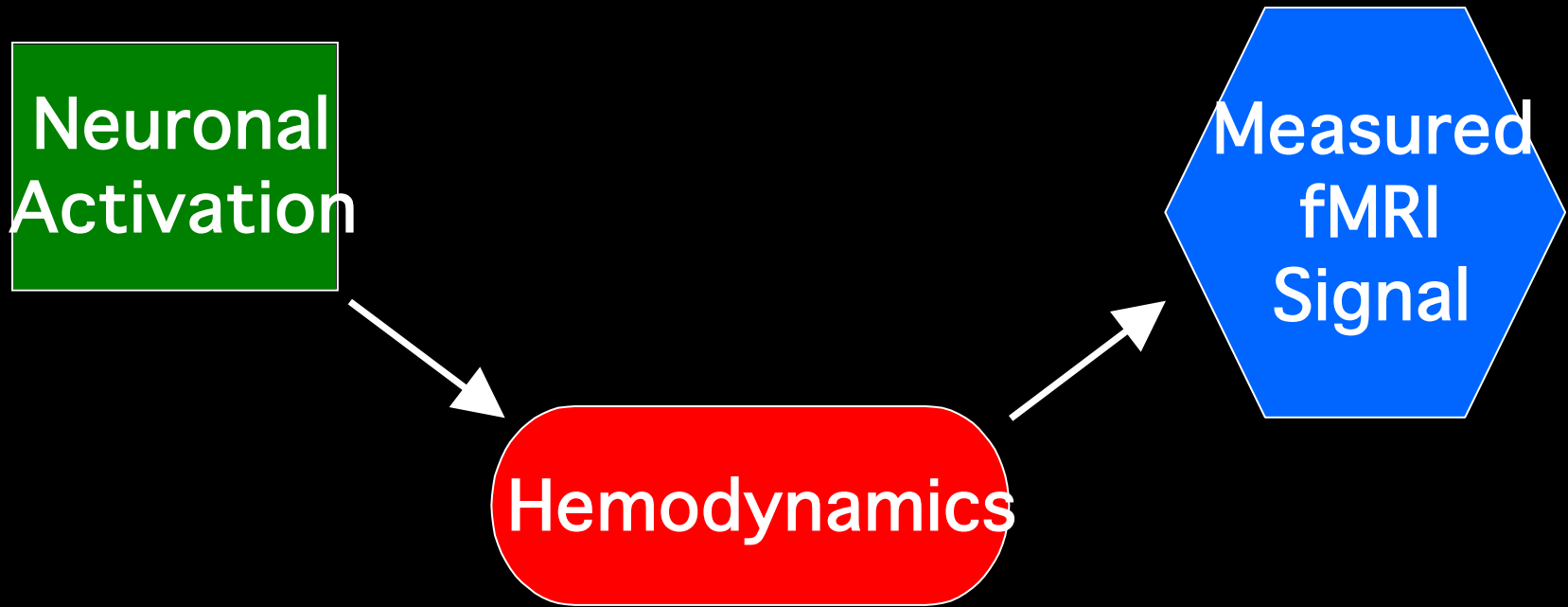

Physiologic Factors

MRI Signal

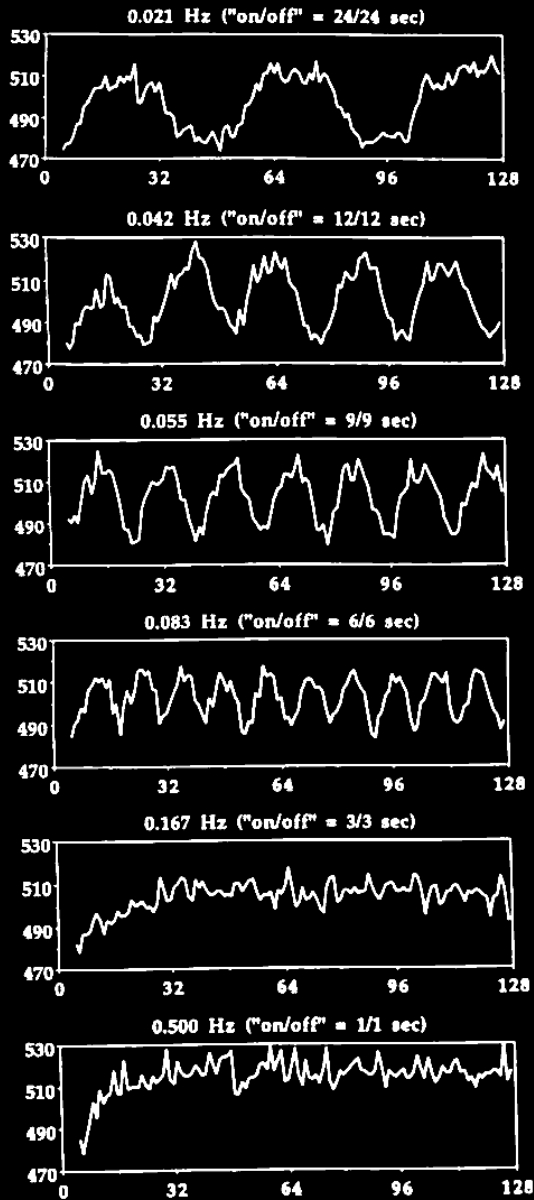

Time (seconds)

Relative Activation - Induced
MR Signal Change

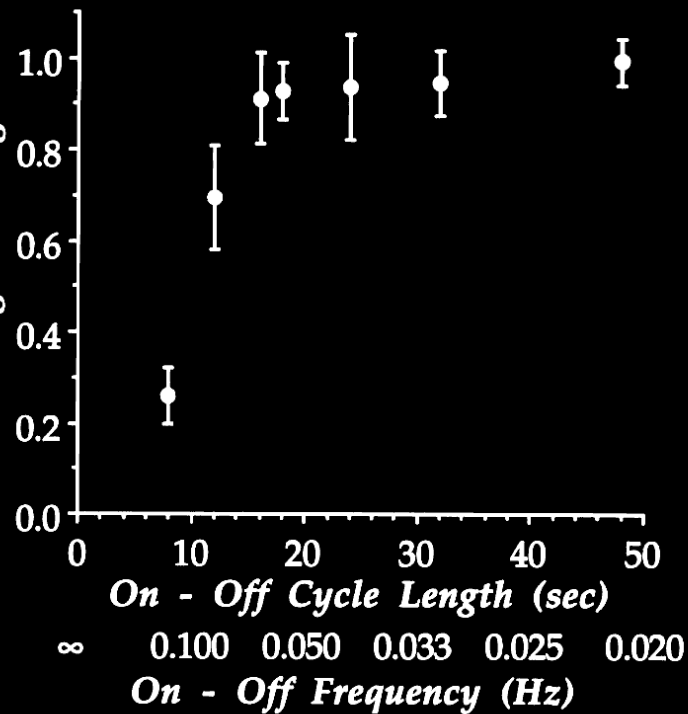

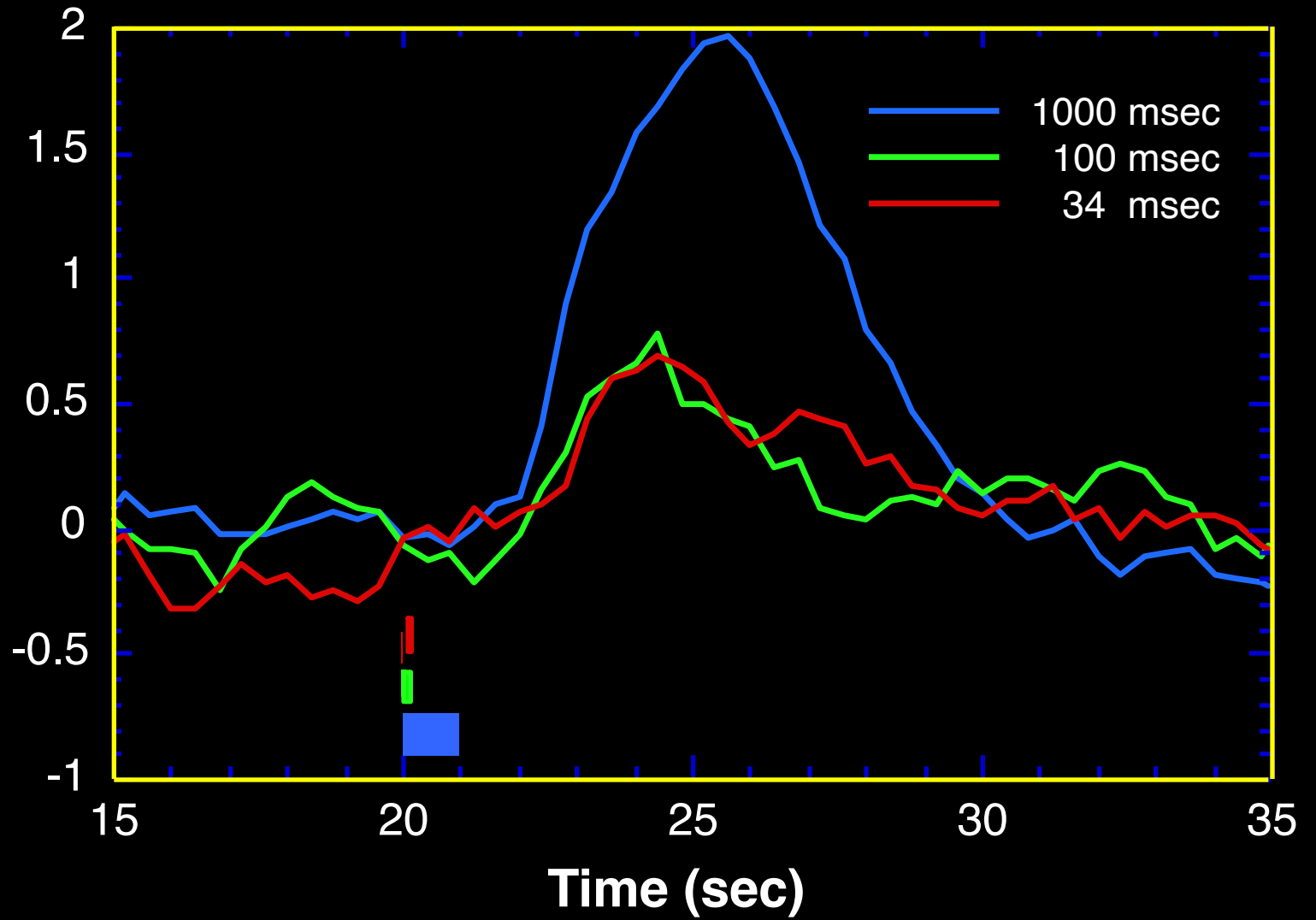

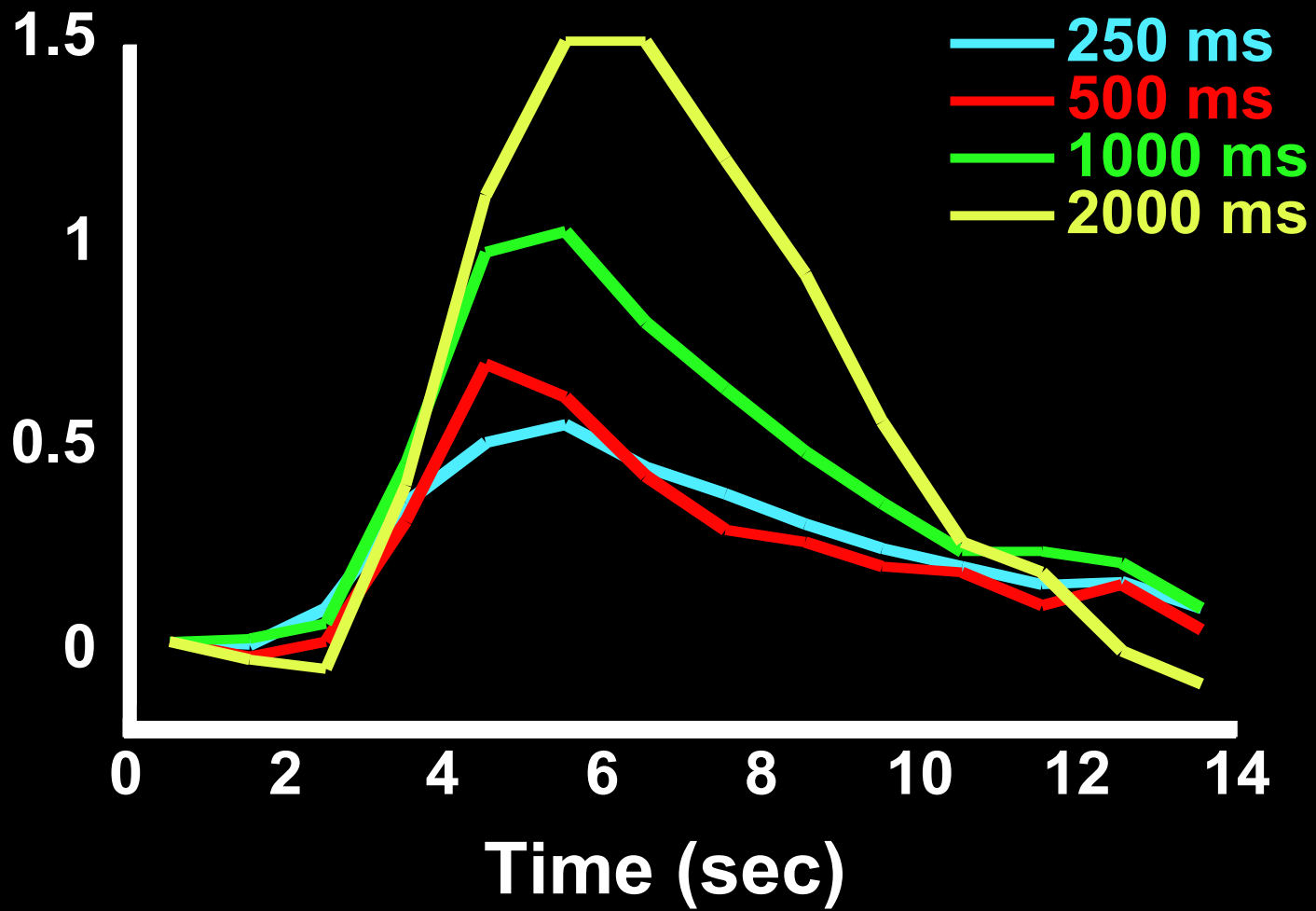

Latency

Magnitude

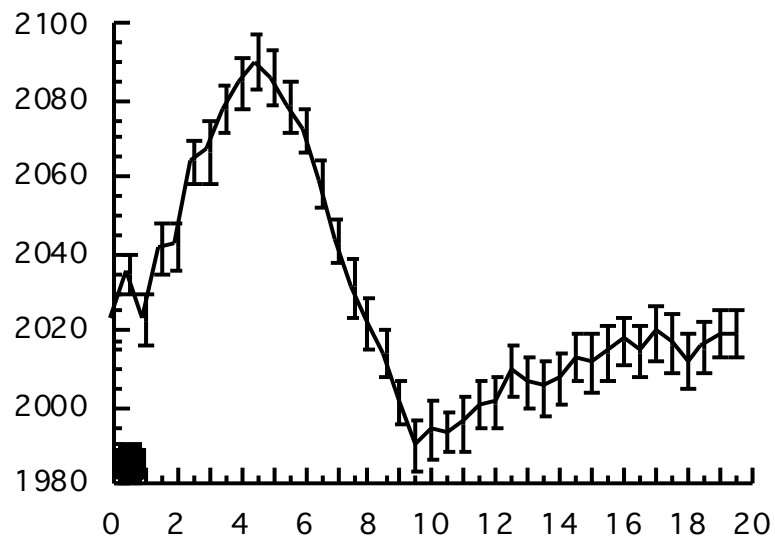
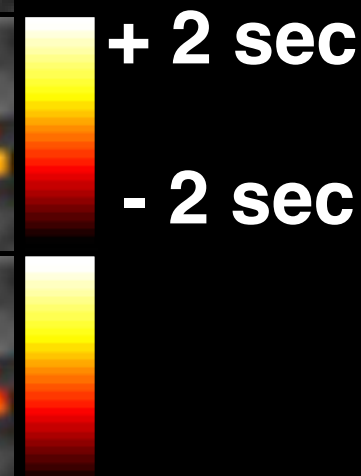
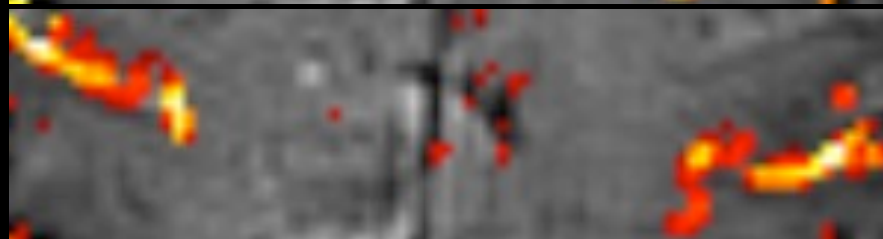
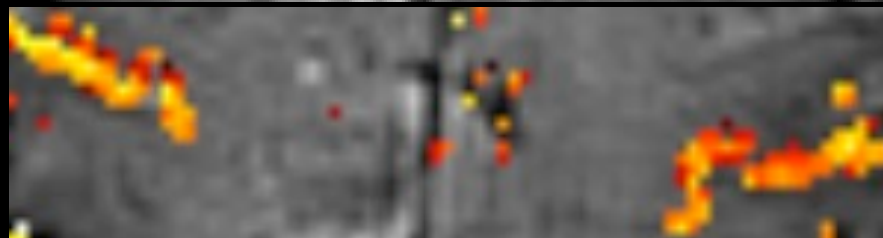

Time (sec)

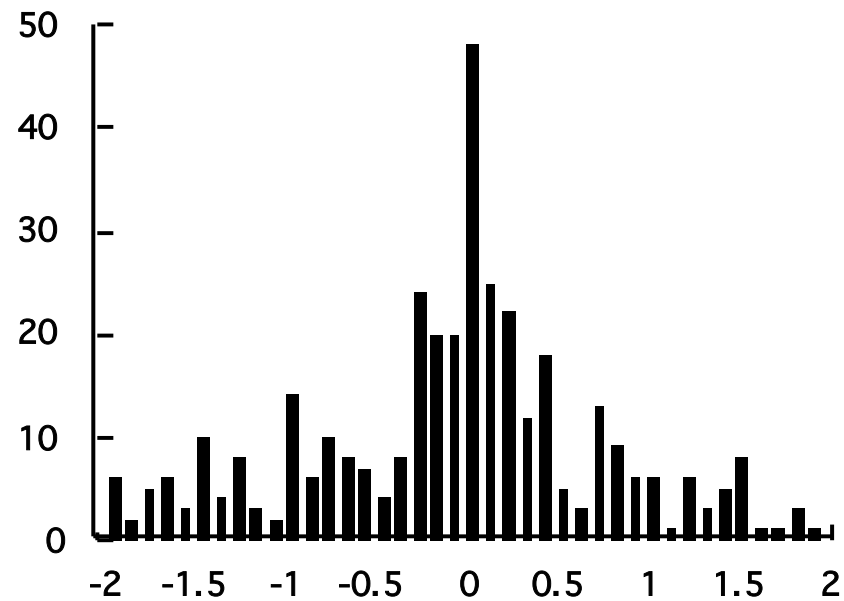

Delay (sec)

Observed Responses

measured

ideal (linear)

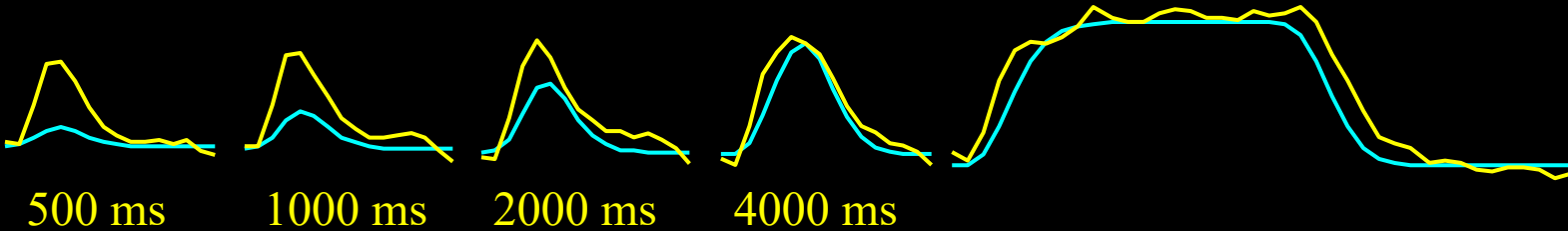
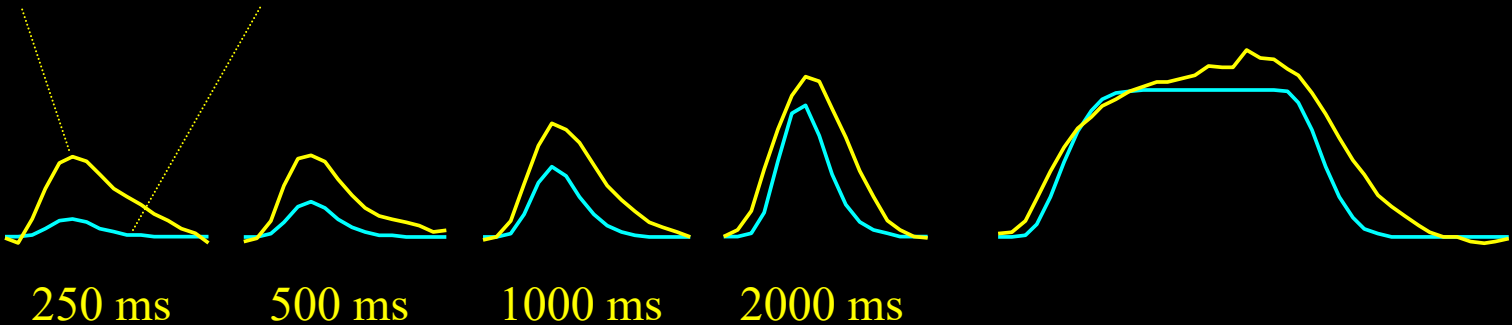

BOLD response is nonlinear

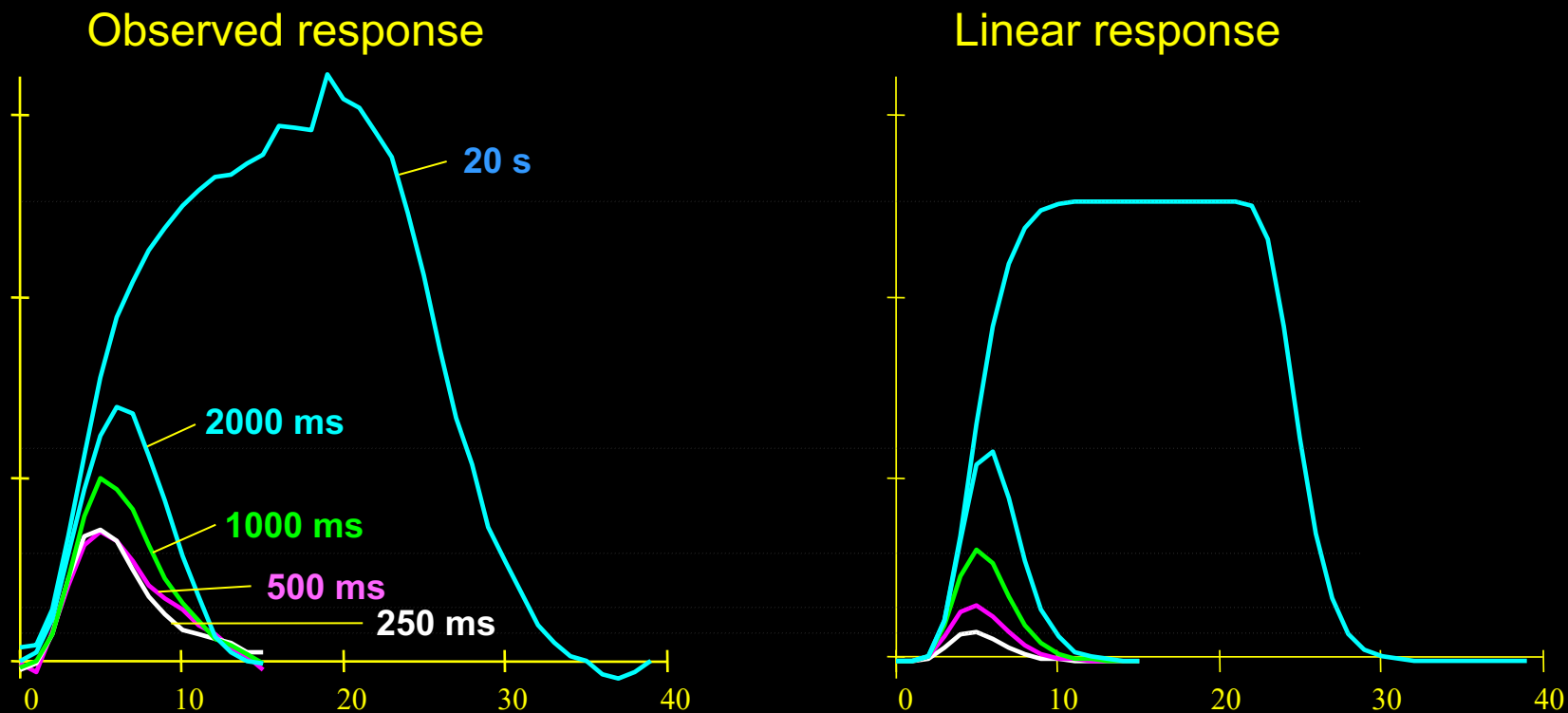

Short duration stimuli produce larger responses than expected

Results — visual task

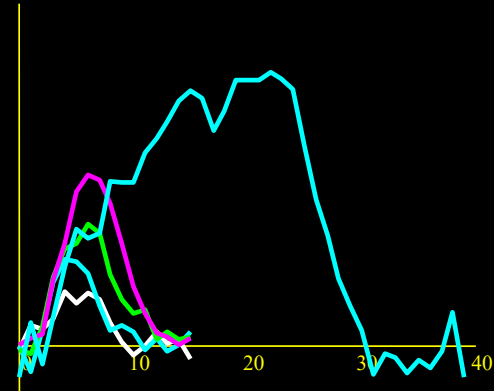
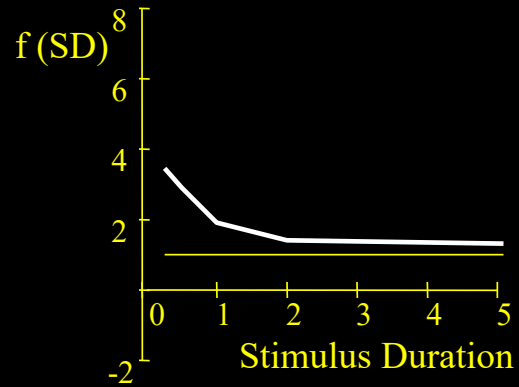
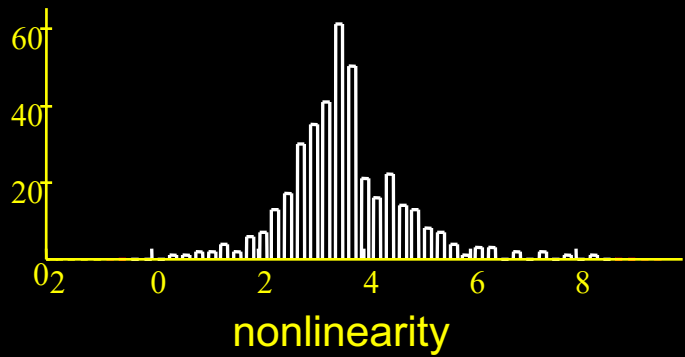
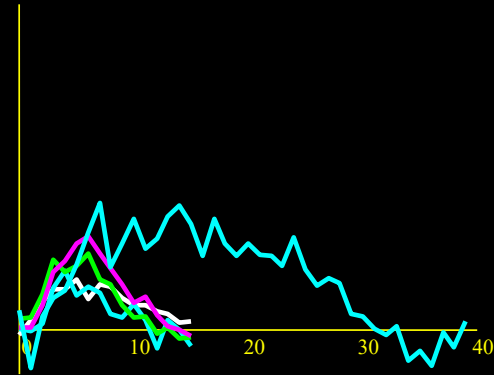
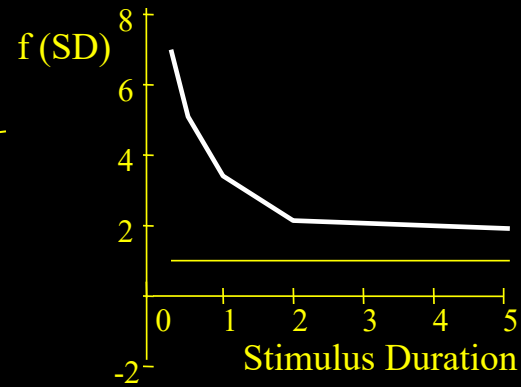
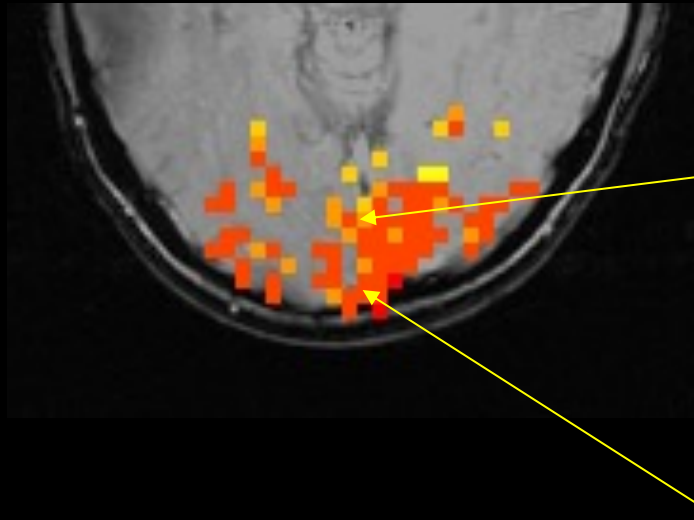

Results — visual task

Nonlinearity

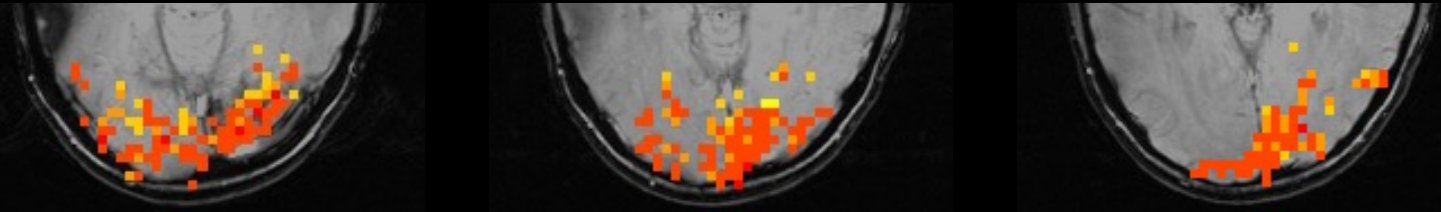

Magnitude

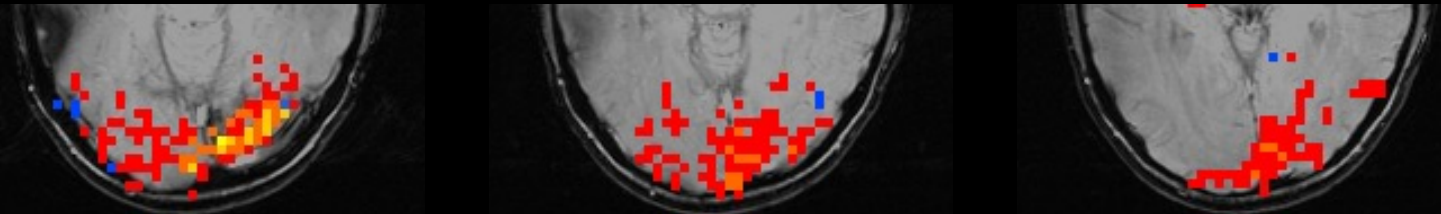

Latency

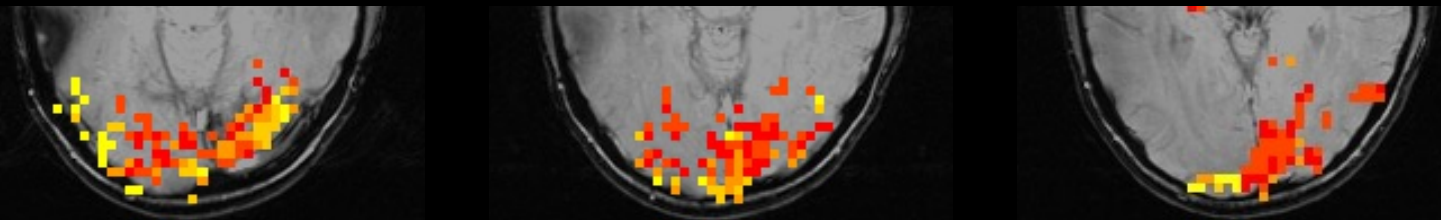

Results — motor task

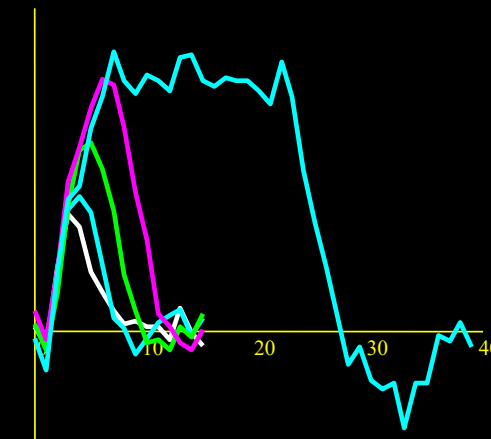
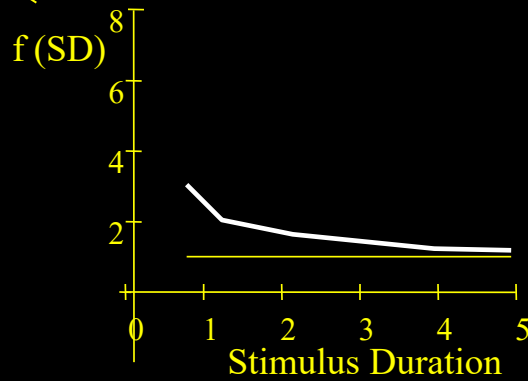
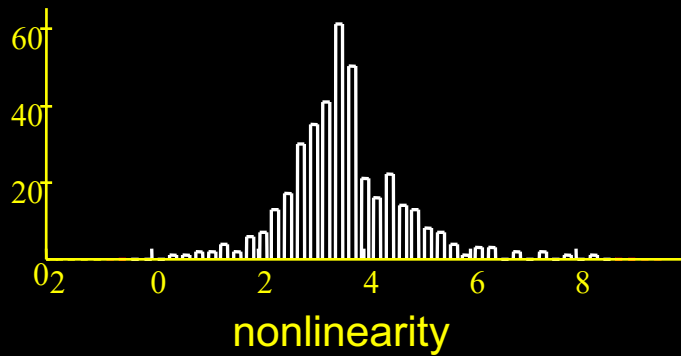
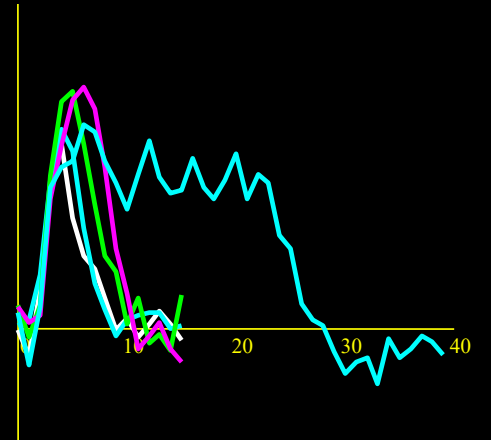
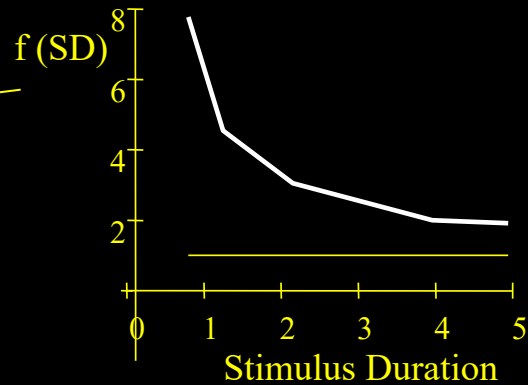
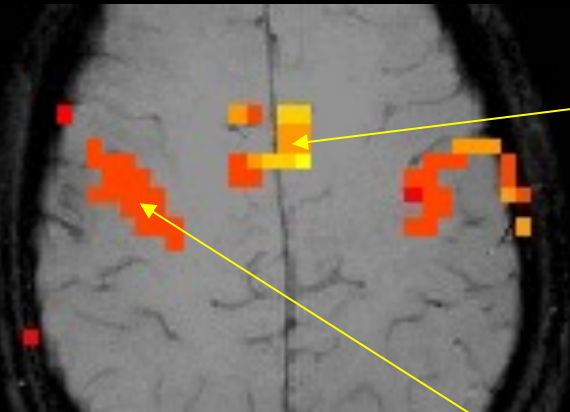

Results — motor task

Nonlinearity

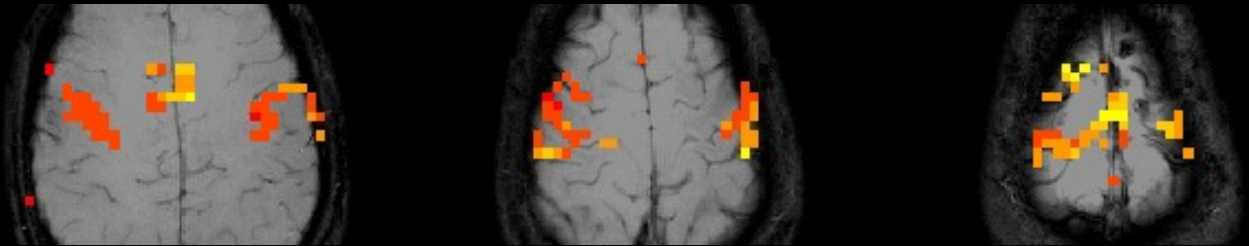

Magnitude

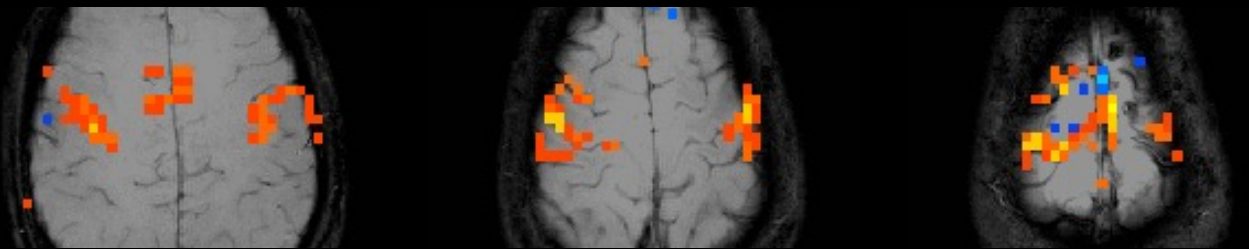

Latency

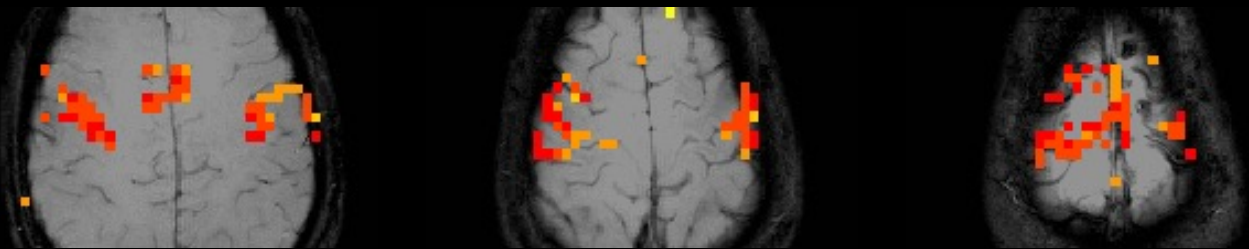

Different stimulus “ON” periods

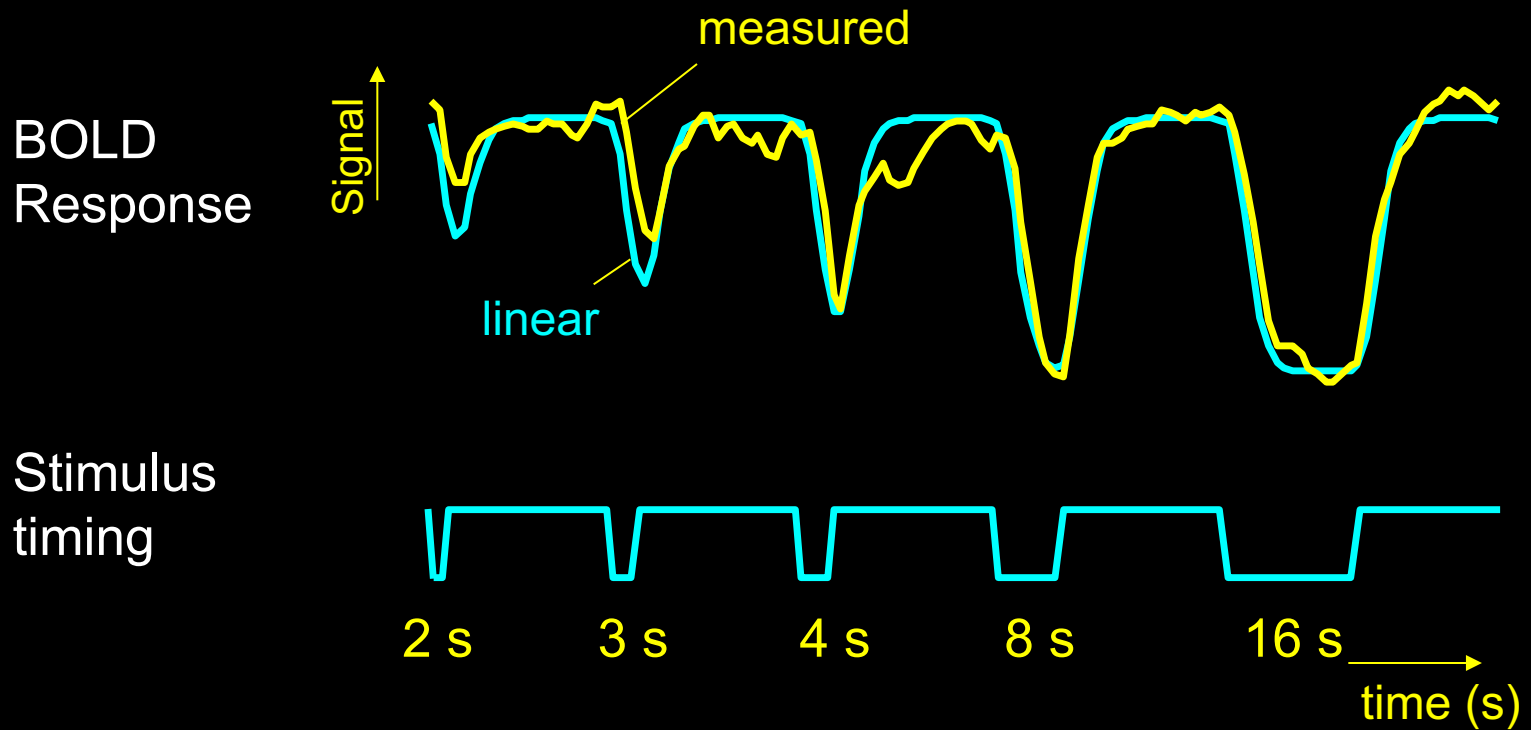

Brief stimulus OFF periods produce smaller decreases than expected

Sources of this Nonlinearity

- Neuronal

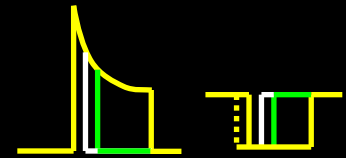
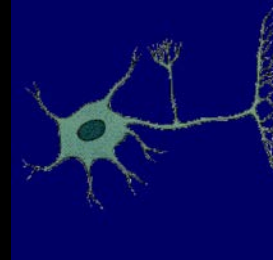

- Hemodynamic

- Oxygen extraction
- Blood volume dynamics

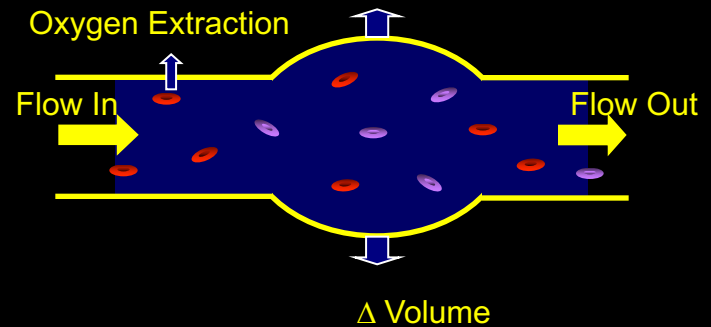

BOLD Correlation with Neuronal Activity

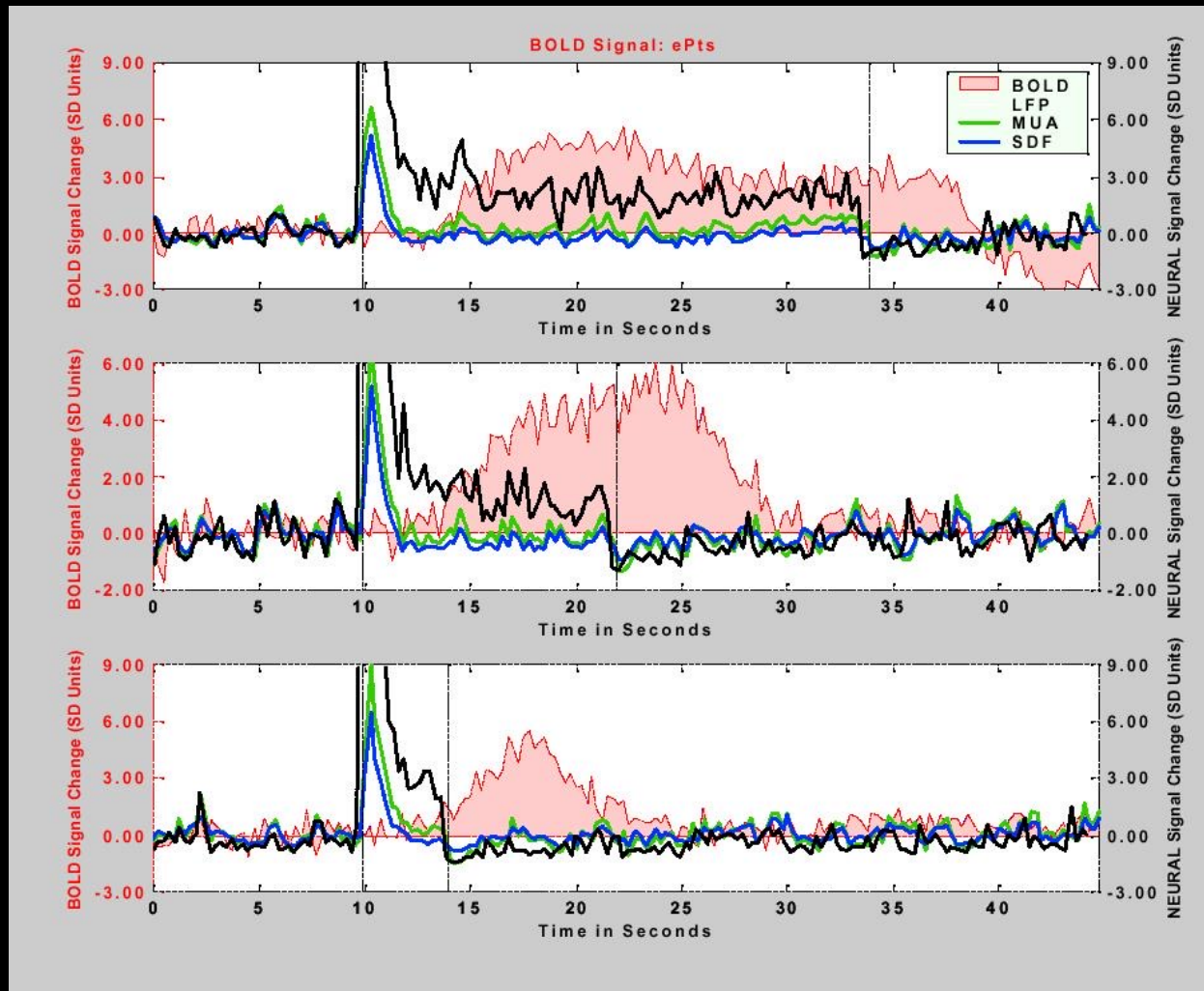

Logothetis et al. Nature, 412, 150-157

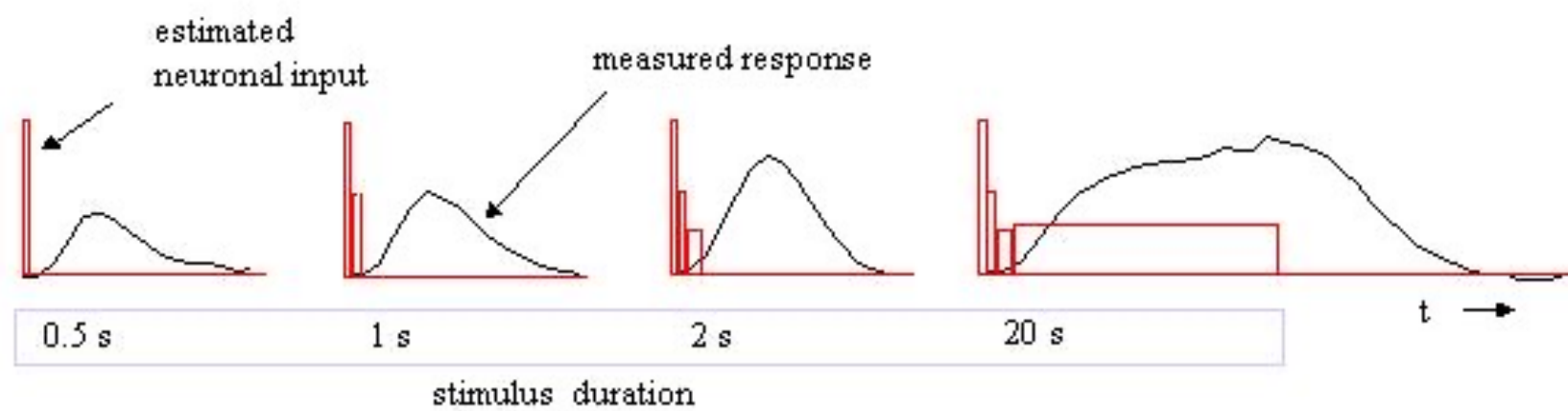
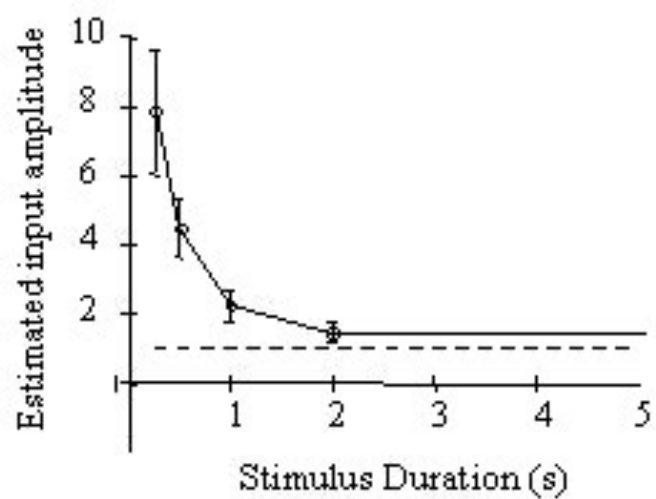
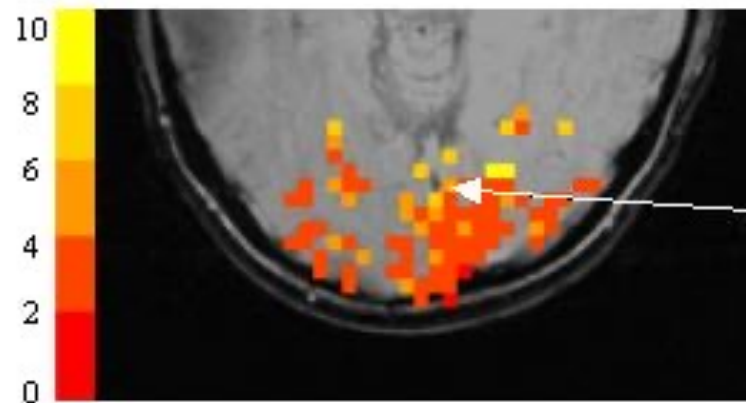

Varying “ON” and “OFF” periods

- *Rapid event-related design with varying ISI*



Varying “ON” and “OFF” periods

Estimated Impulse Response

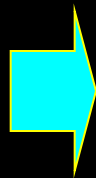
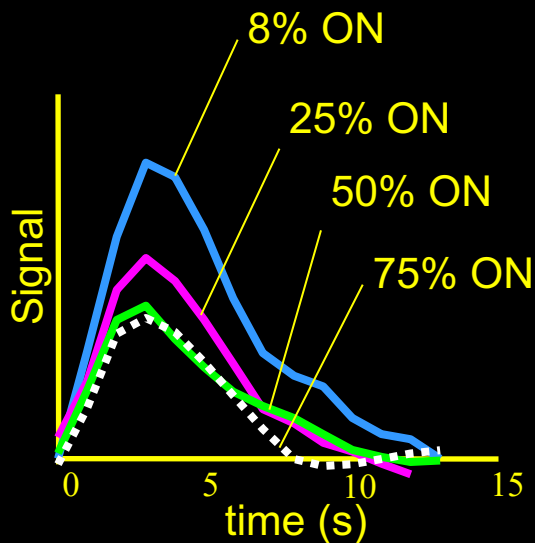

Predicted Responses to 20 s stimulation

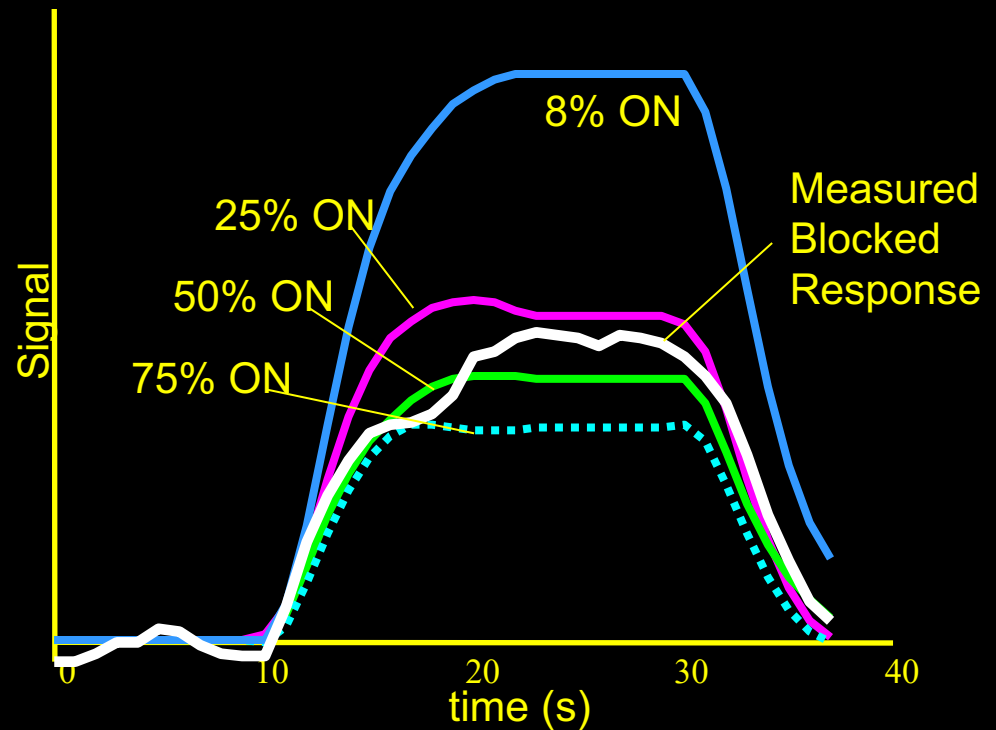

Motor Cortex

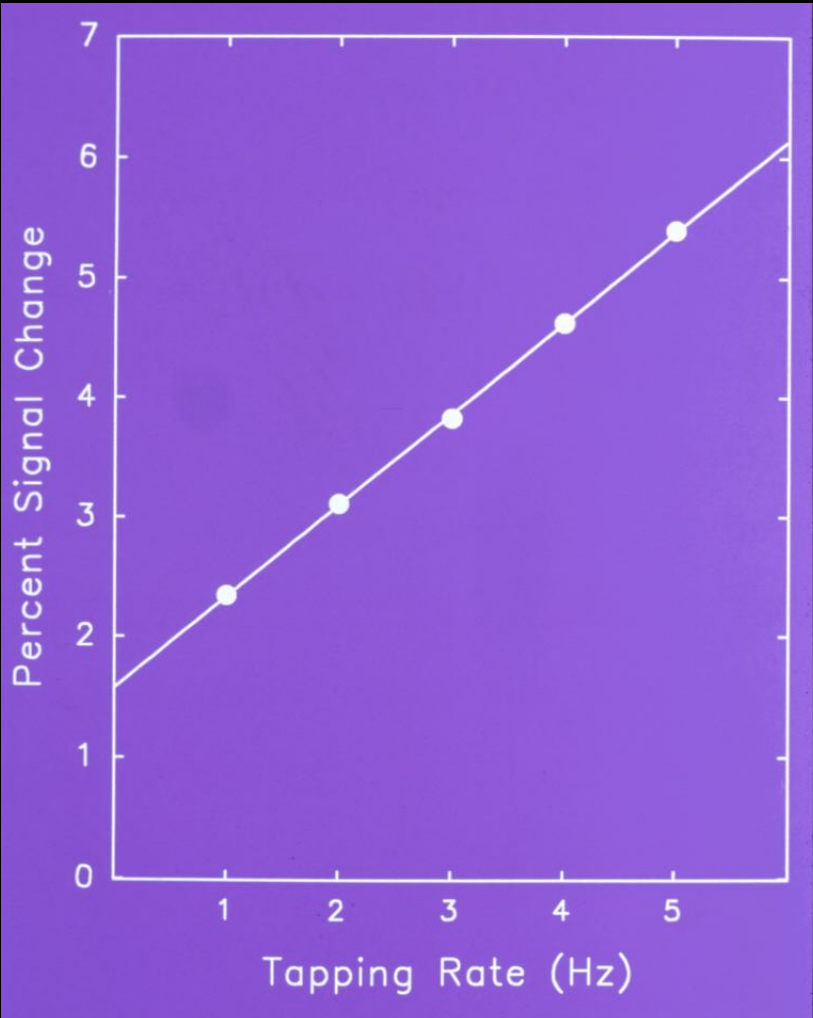

Auditory Cortex

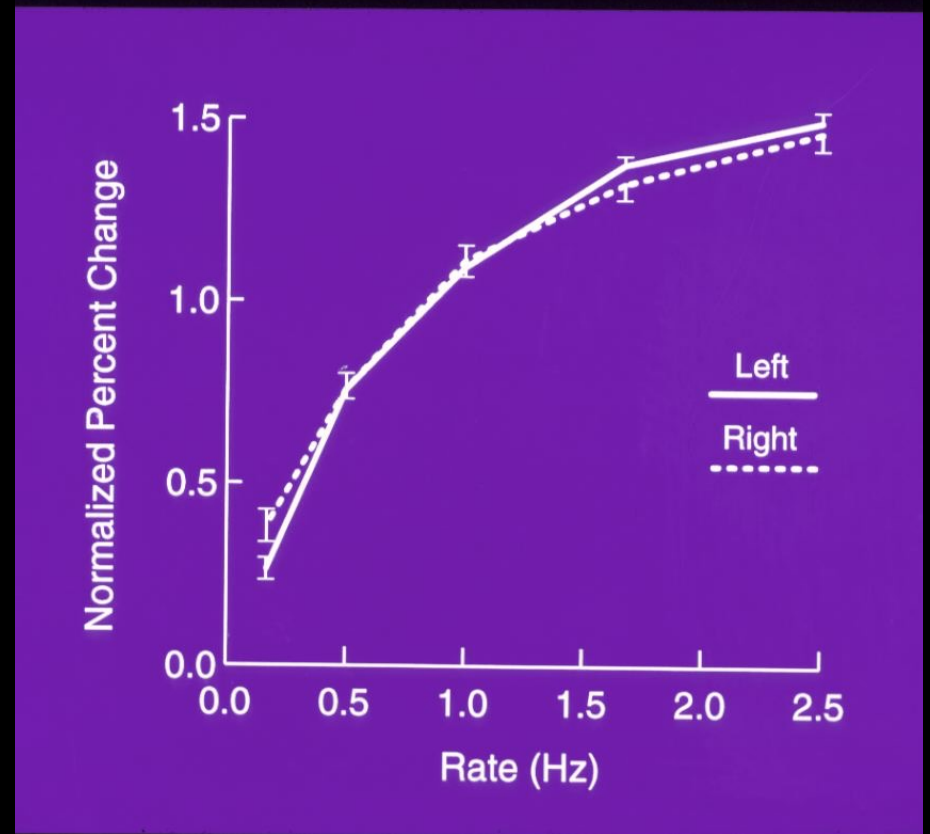

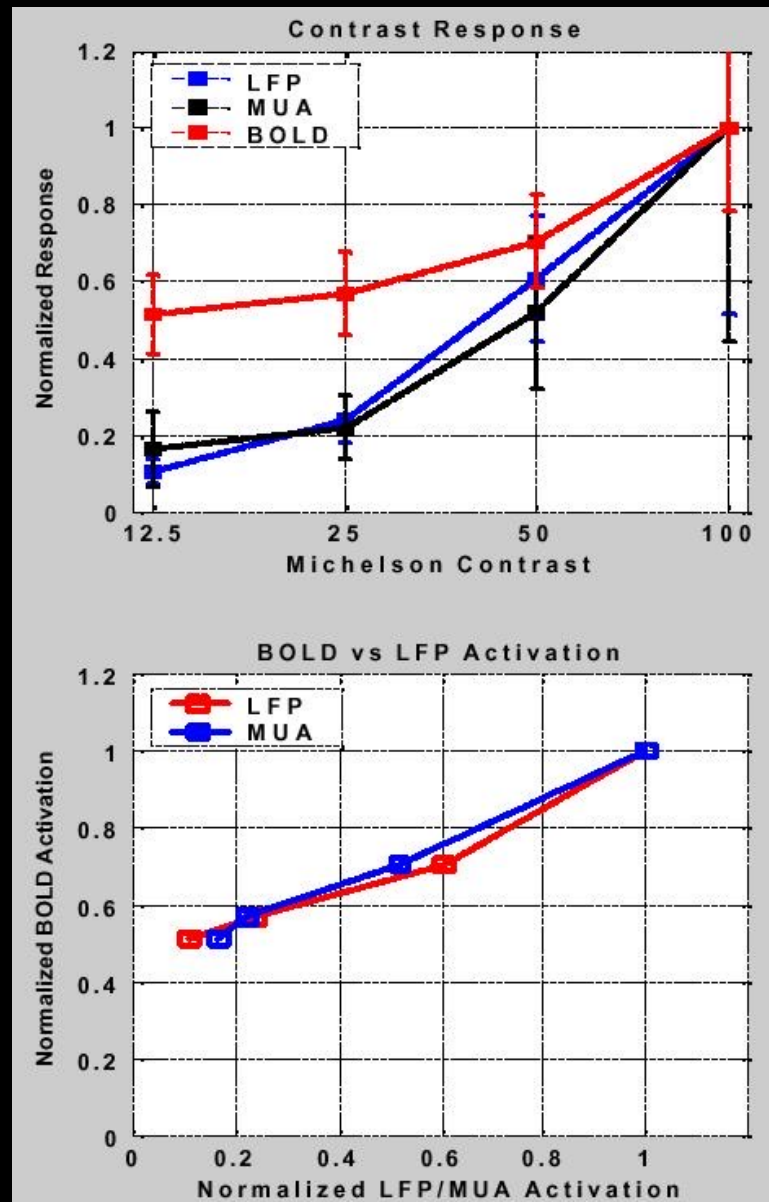

Logothetis et al. Nature, 412, 150-157

- Contrast in fMRI

Hemodynamic Specificity

- The Hemodynamic Transfer Function

Location, Latency, Magnitude

- **Best Results So Far**

Temporal Resolution, Spatial Resolution

- Neuronal Activation Input Strategies

Block Design

Phase and Frequency Encoding

Orthogonal Designs

Parametric Designs

Event-Related Designs

Free Behavior Designs

Time Course Comparison Across Brain Regions

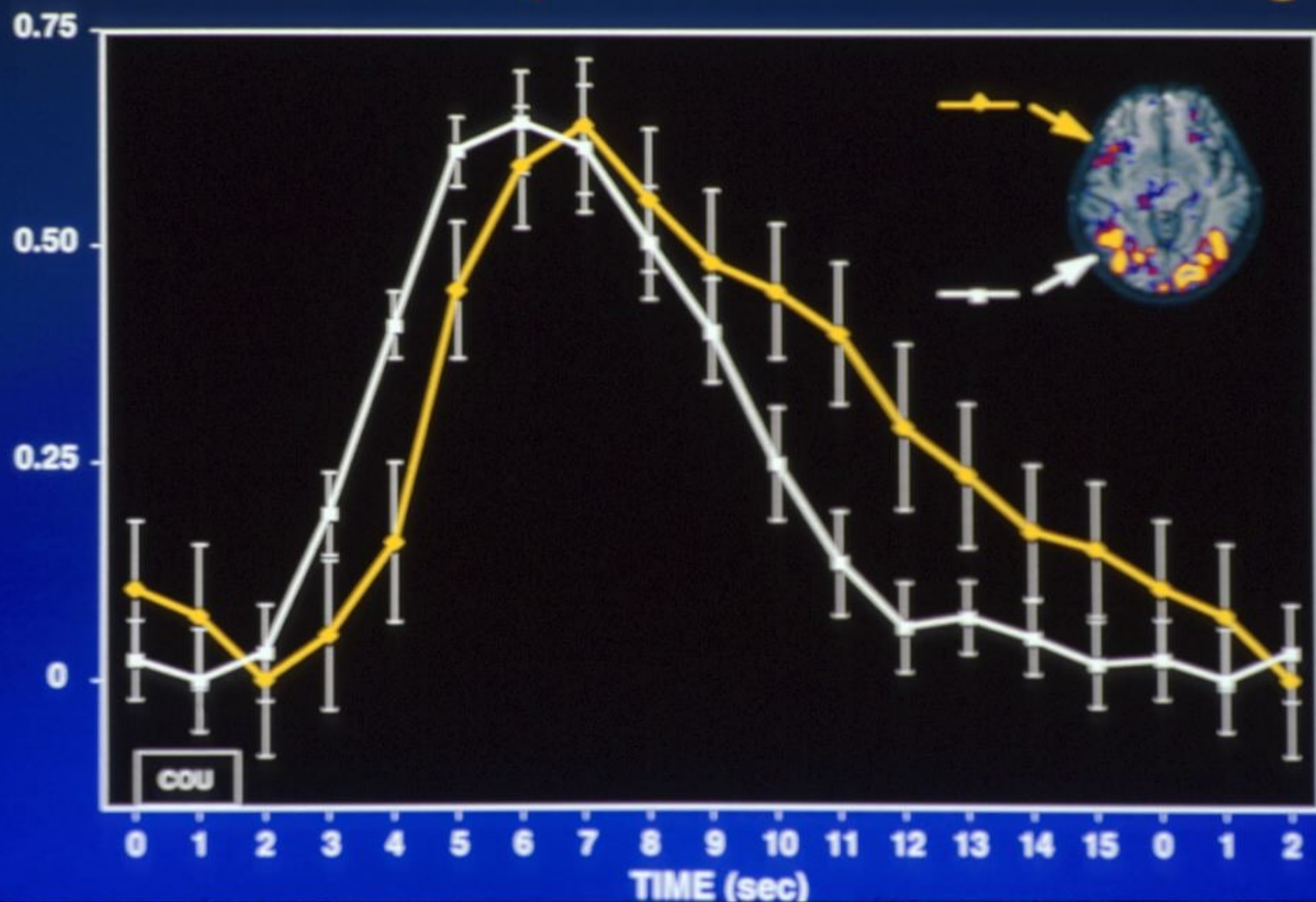

Latency

Magnitude

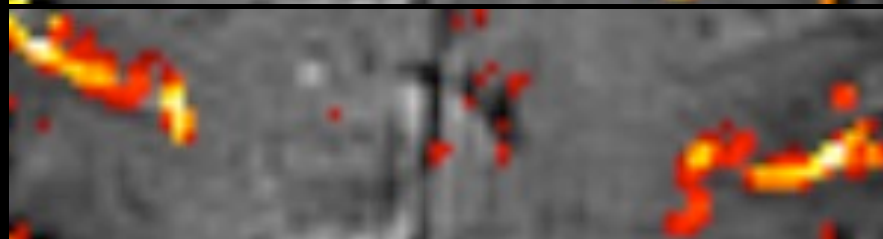
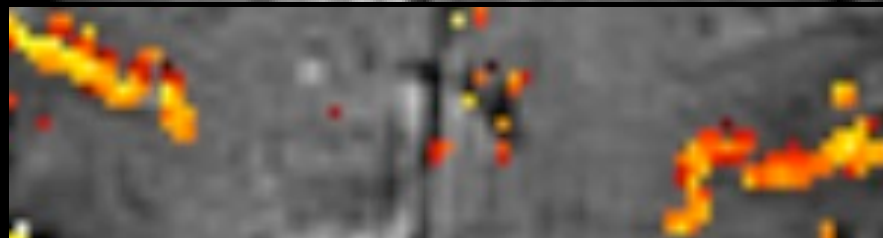

+ 2 sec

- 2 sec

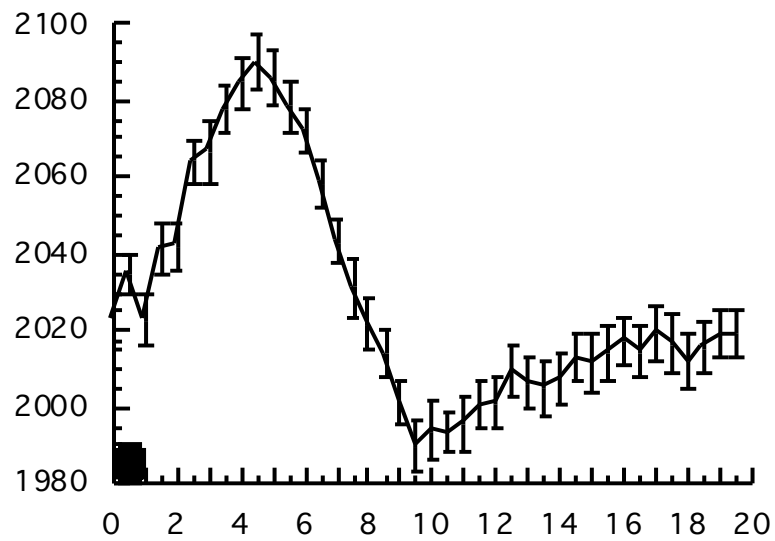

Time (sec)

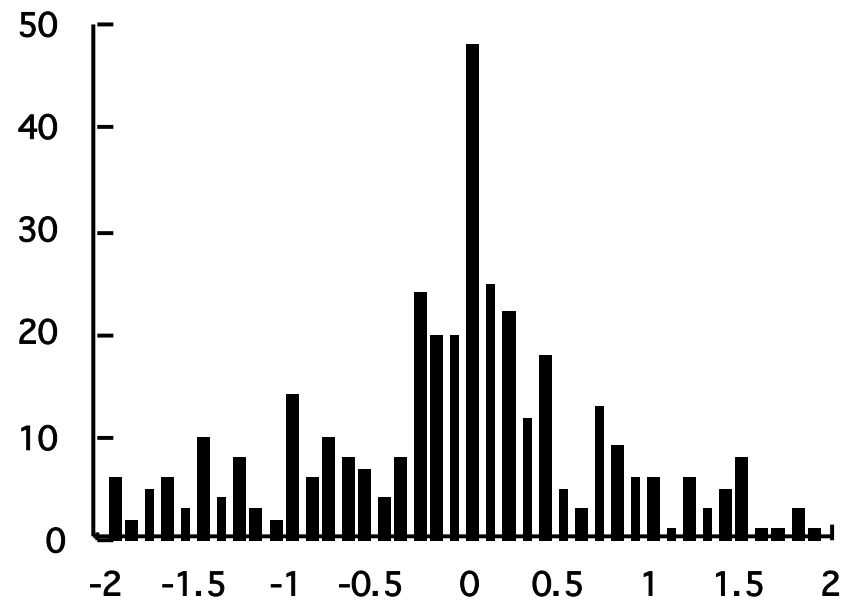

Delay (sec)

Regions of Interest Used for Hemi-Field Experiment

**Right
Hemisphere**

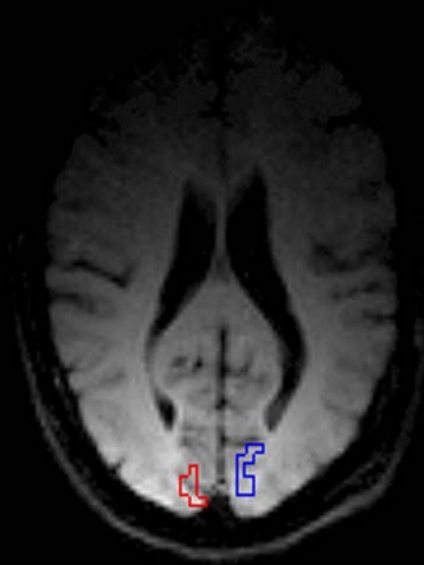

**Left
Hemisphere**

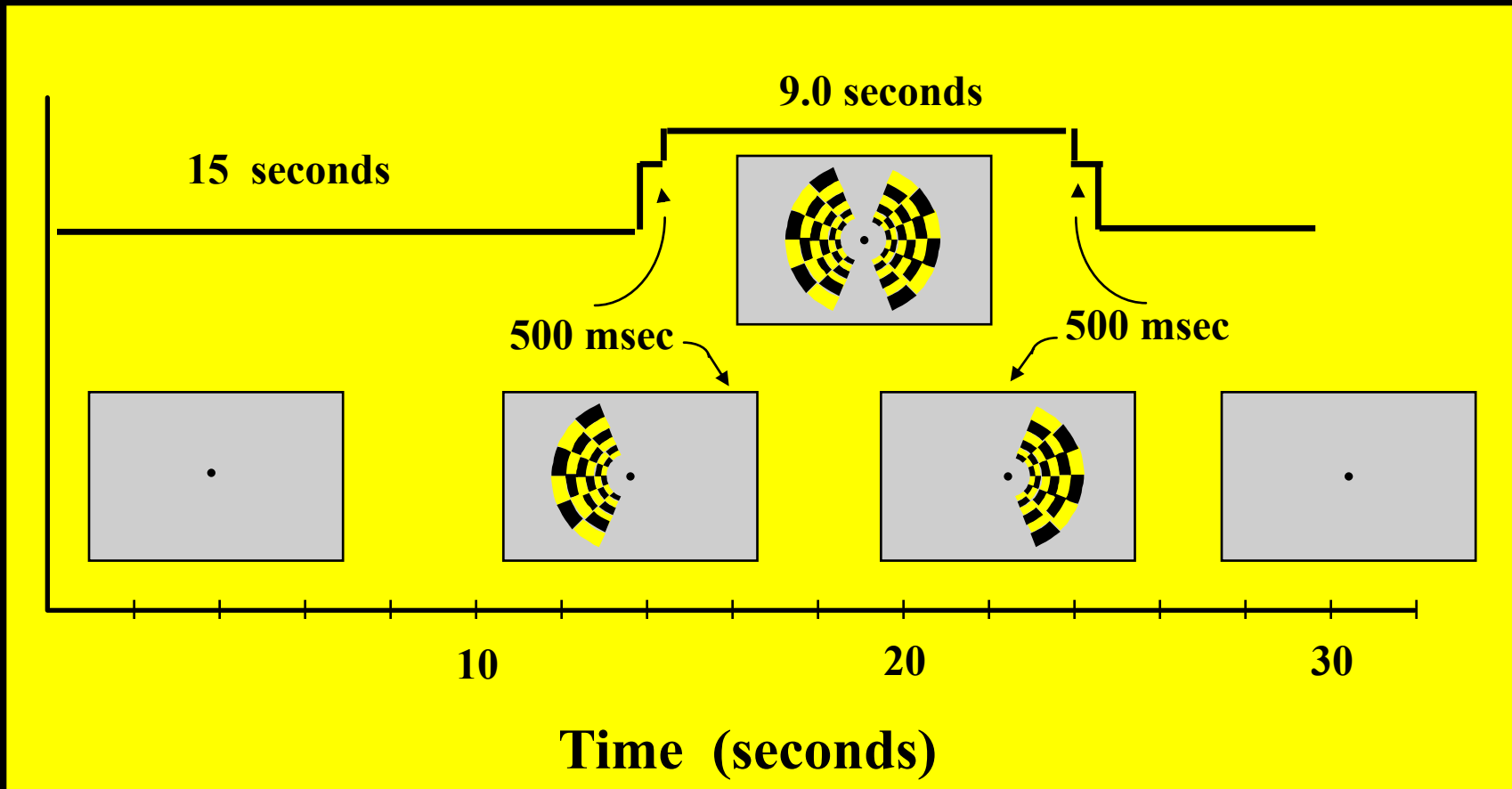

Hemi-field with 500 msec asynchrony

Average of 6 runs Standard Deviations Shown

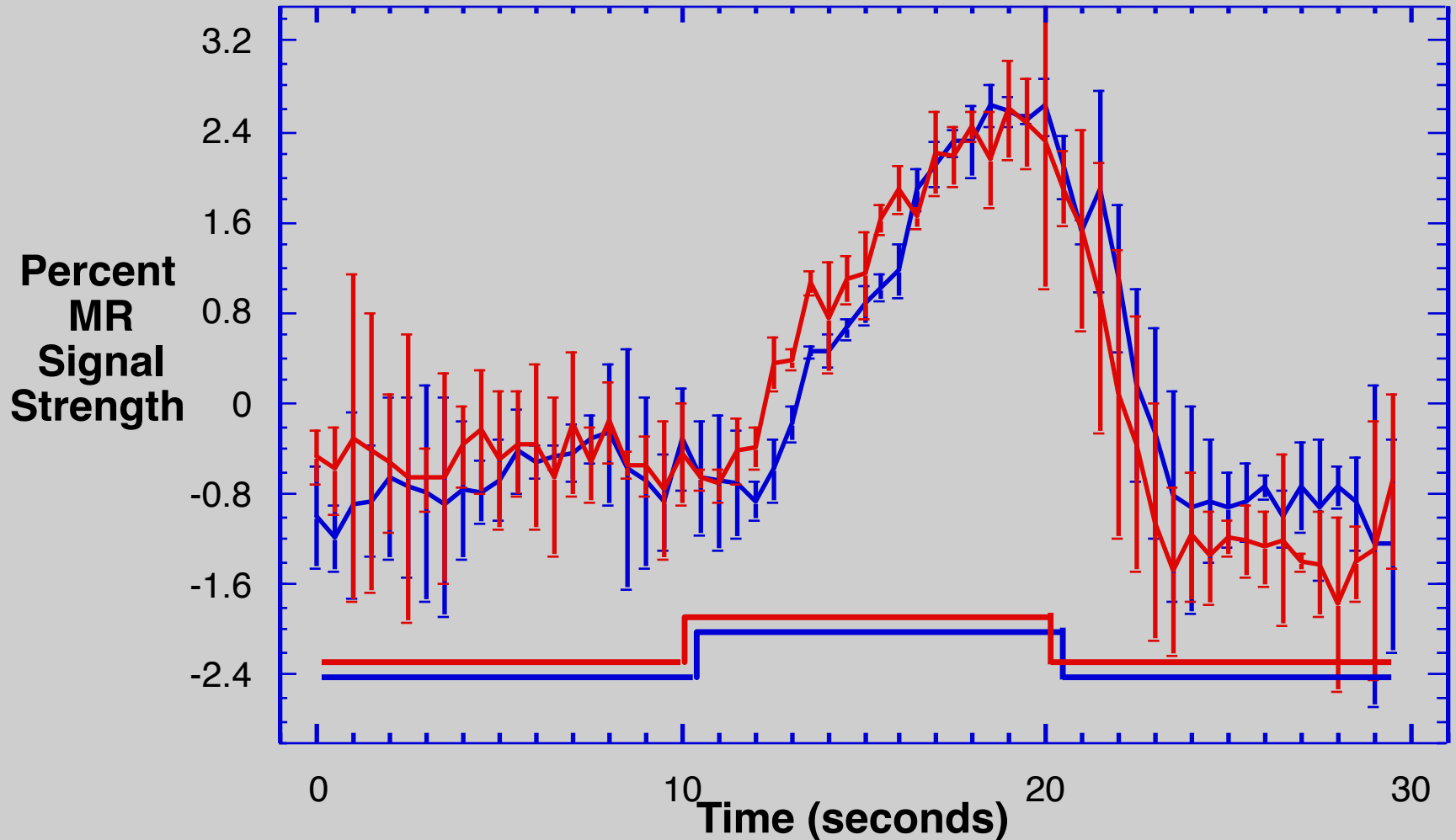

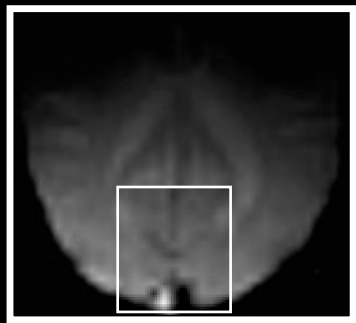

500 ms

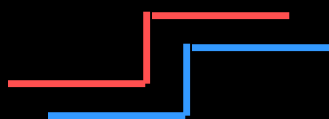

500 ms



Right Hemifield

Left Hemifield

+ 2.5 s

0 s

- 2.5 s

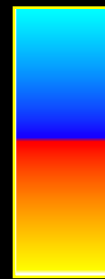
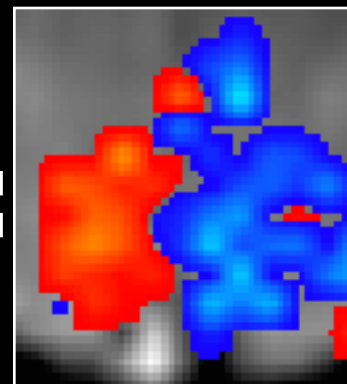
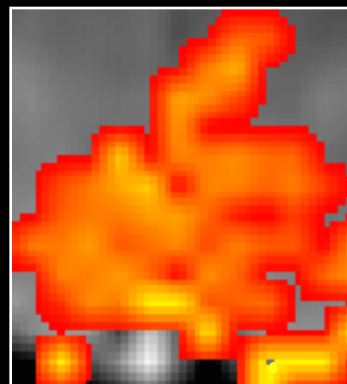
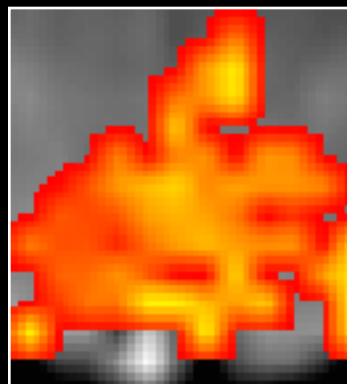

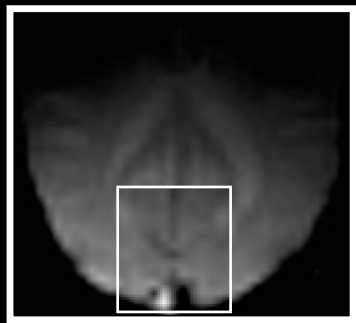

250 ms



250 ms



Right Hemifield

Left Hemifield

+ 2.5 s

0 s

- 2.5 s

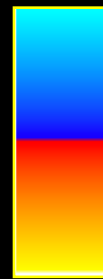
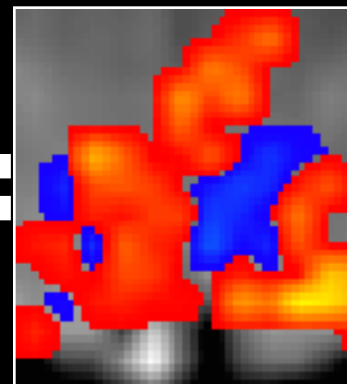
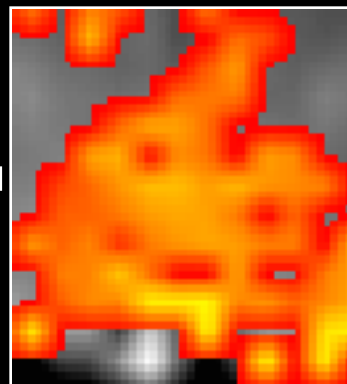
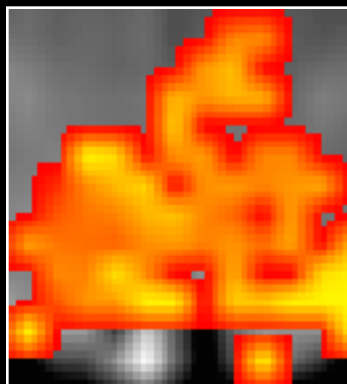

Single Shot Imaging

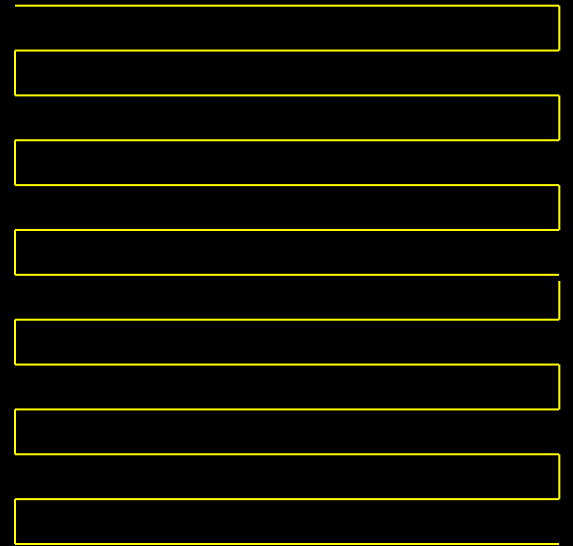
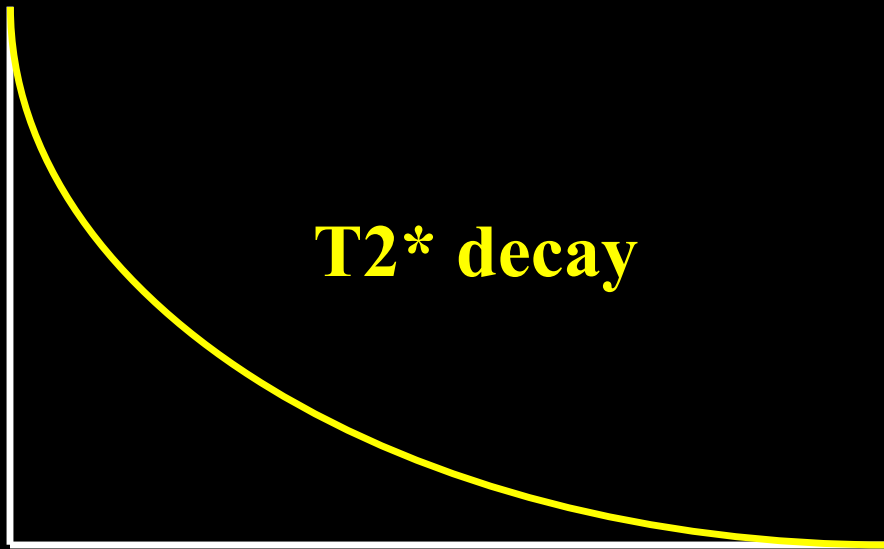

EPI Readout Window

≈ 20 to 40 ms

Multishot Imaging



EPI Window 1

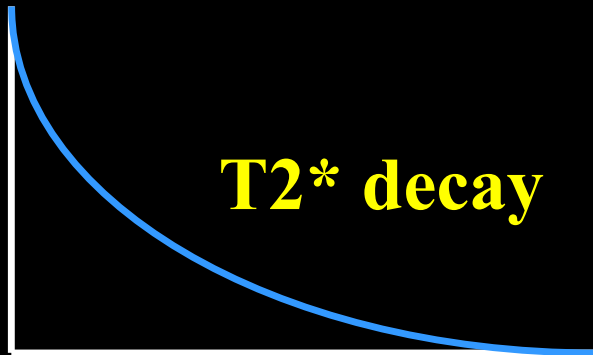

EPI Window 2

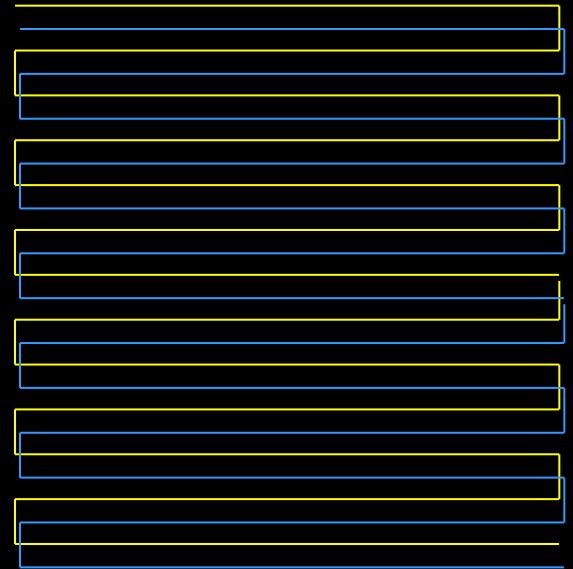

Multi Shot EPI

Excitations
Matrix Size

1

64 x 64

2

128 x 128

4

256 x 128

8

256

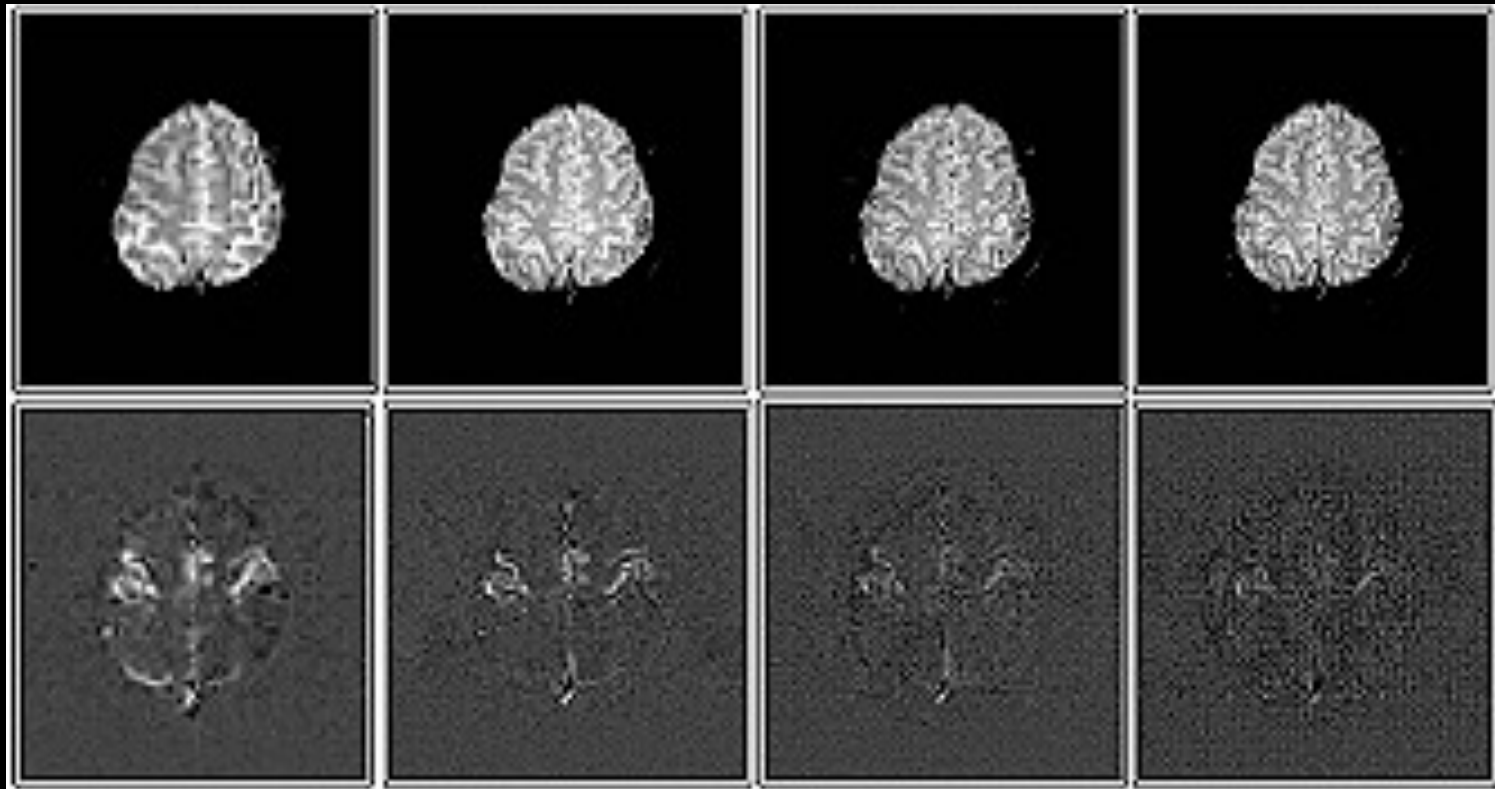

Partial k-space imaging

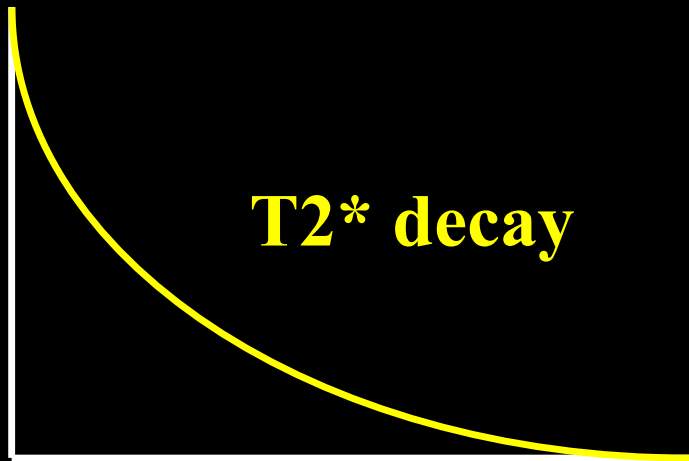

EPI Window

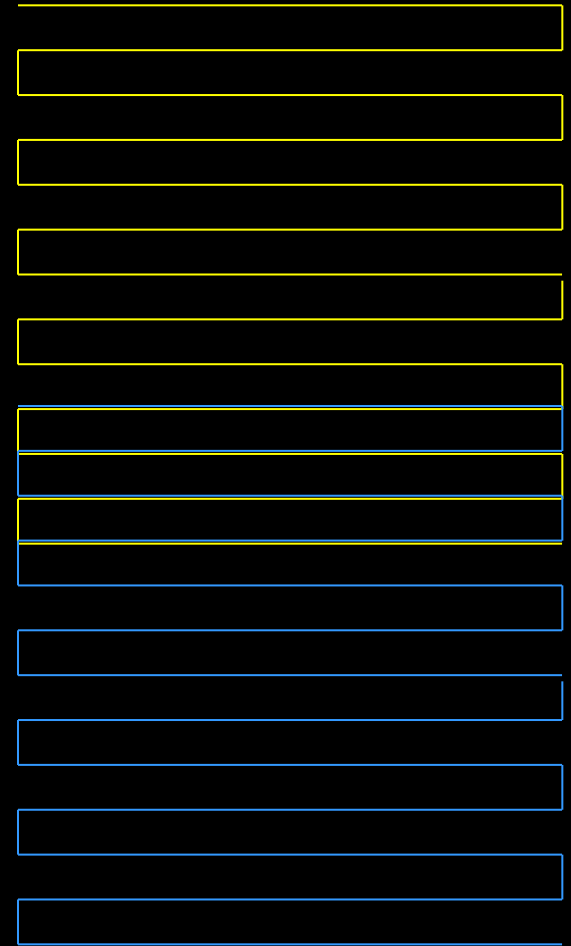

**Single - Shot EPI at 3T:
Half NEX, 256 x 256, 16 cm FOV**

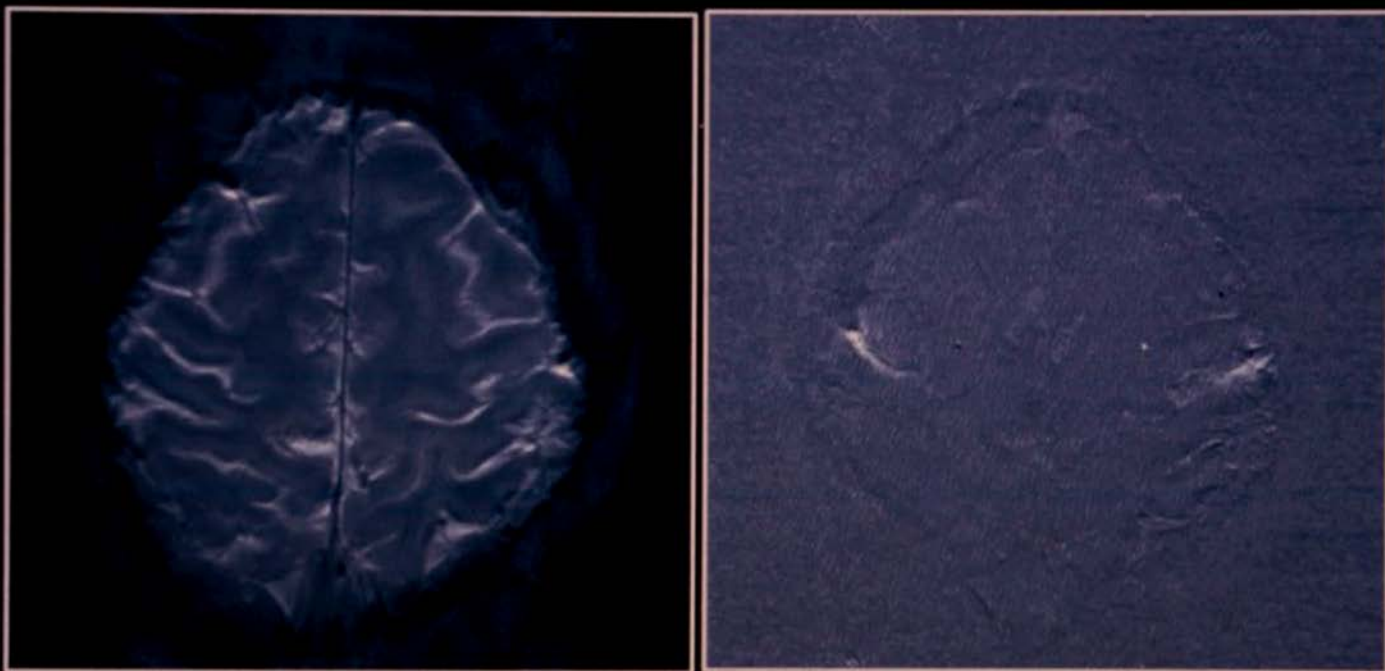

Fractional Signal Change

2.5 mm²

1.25 mm²

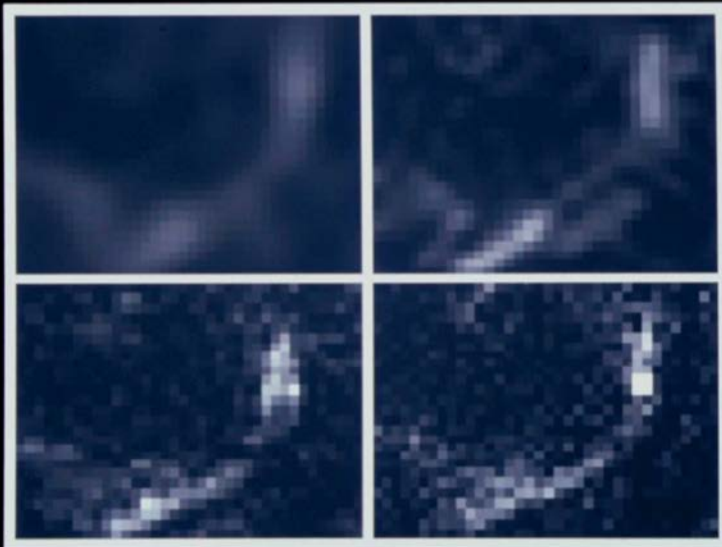

0.83 mm²

0.62 mm²

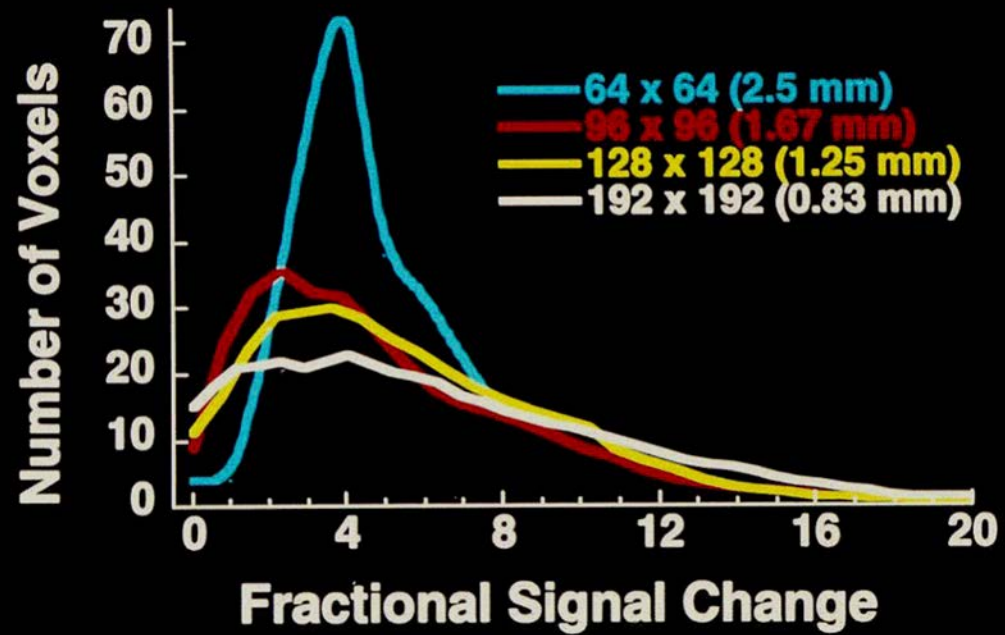

ODC Maps using fMRI

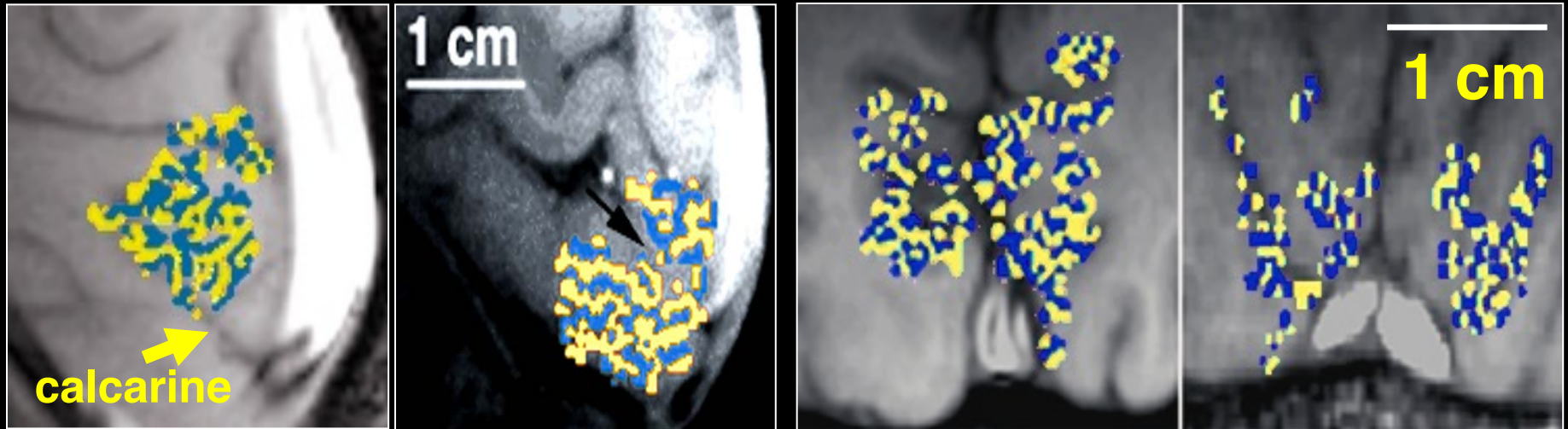

• Identical in size, orientation, and appearance to those obtained by optical imaging¹ and histology^{3,4}.

¹Malonek D, Grinvald A. *Science* 272, 551-4 (1996).

³Horton JC, Hocking DR. *J Neurosci* 16, 7228-39 (1996).

⁴Horton JC, et al. *Arch Ophthalmol* 108, 1025-31 (1990).

Why short is better than long

The vascular response to prolonged neural stimulation

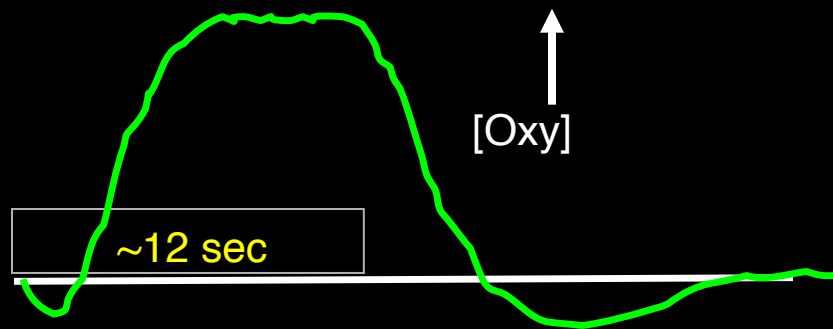

It is argued that fMRI cannot achieve submillimeter functional resolution because a saturated hyperoxic vascular response to neural activity spreads over many millimeters^{1,2}.

However, optical imaging has demonstrated that the hyperoxic response can yield well-localized maps when using short duration stimuli (<5 sec)¹.

The vascular response to brief neural stimulation

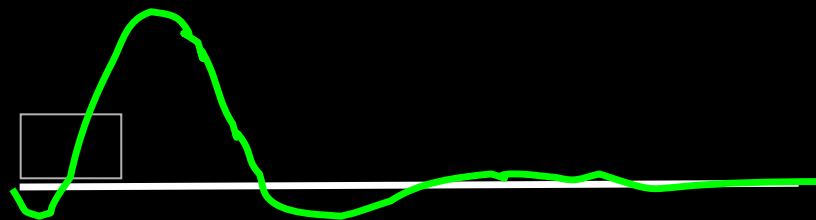

¹Malonek D, Grinvald A. Science 272, 551-4 (1996).

²Kim D-S, Duong T, Kim S-G. Nat Neurosci 3, 164-9 (2000).

- Contrast in fMRI

Hemodynamic Specificity

- The Hemodynamic Transfer Function

Location, Latency, Magnitude

- Best Results So Far

Temporal Resolution, Spatial Resolution

- **Neuronal Activation Input Strategies**

Block Design

Phase and Frequency Encoding

Orthogonal Designs

Parametric Designs

Event-Related Designs

Free Behavior Designs

Neuronal Activation Input Strategies

1. Block Design

2. Frequency Encoding

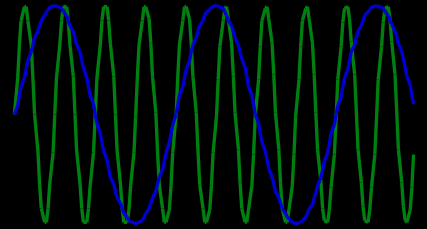

3. Phase Encoding

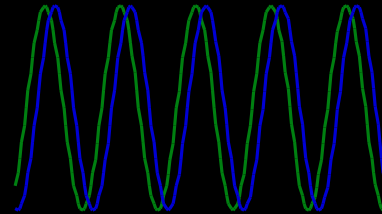

4. Single Event

5. Orthogonal Block Design

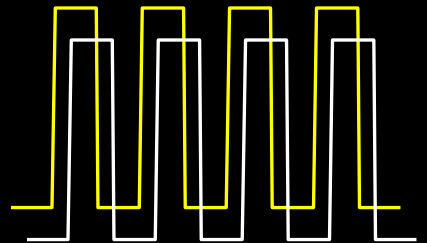

6. Free Behavior Design.

Neuronal Activation Input Strategies

1. Block Design

2. Frequency Encoding

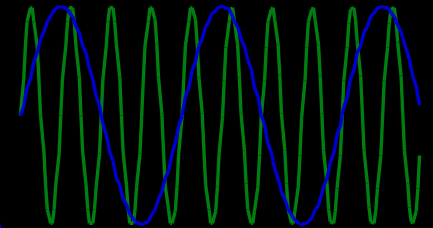

3. Phase Encoding

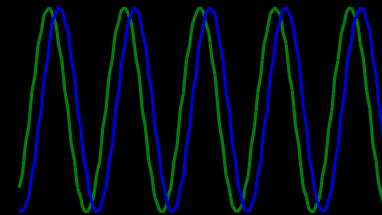

4. Single Event

5. Orthogonal Block Design

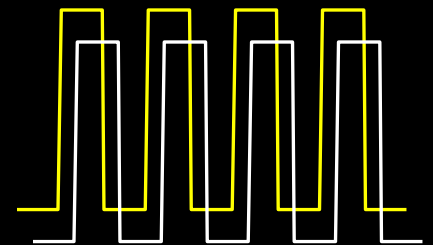

6. Free Behavior Design.

Both the Task and Presentation Rate Affect the fMRI Response

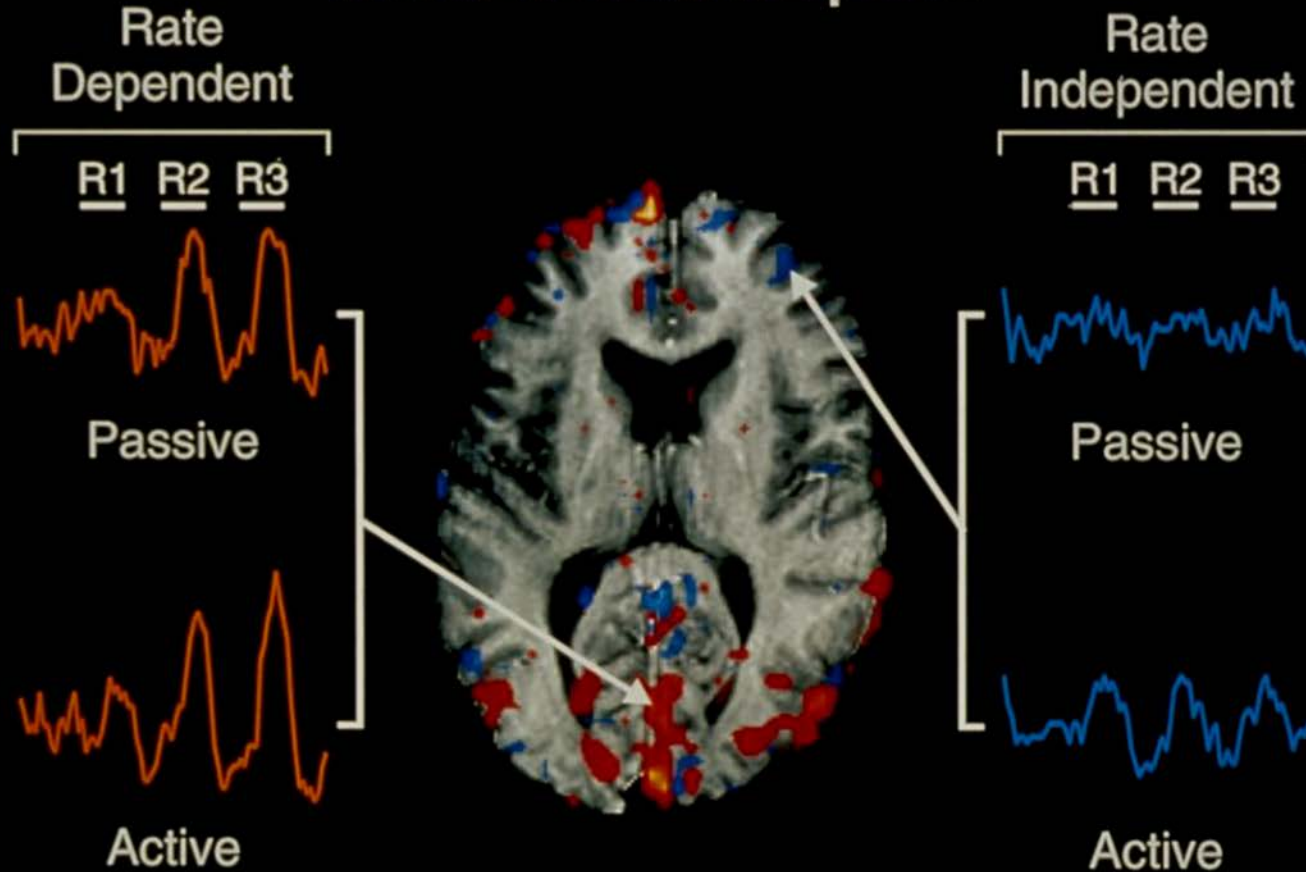

DeYoe et al.

Neuronal Activation Input Strategies

1. Block Design

2. Frequency Encoding

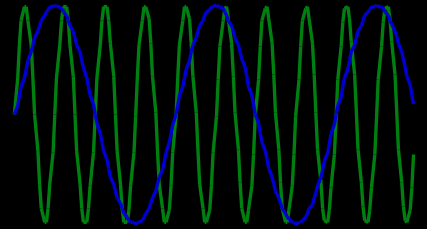

3. Phase Encoding

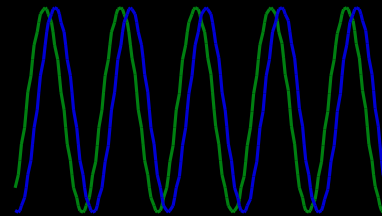

4. Single Event

5. Orthogonal Block Design

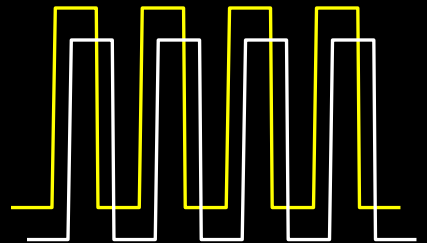

6. Free Behavior Design.

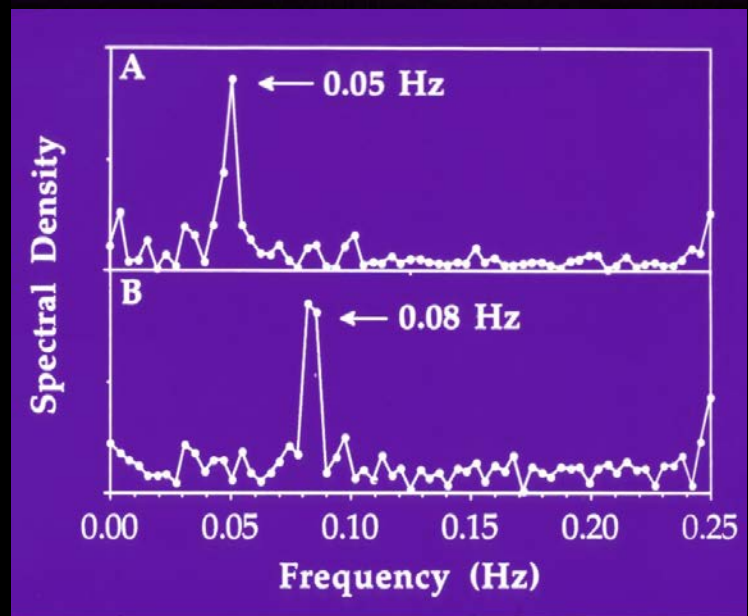
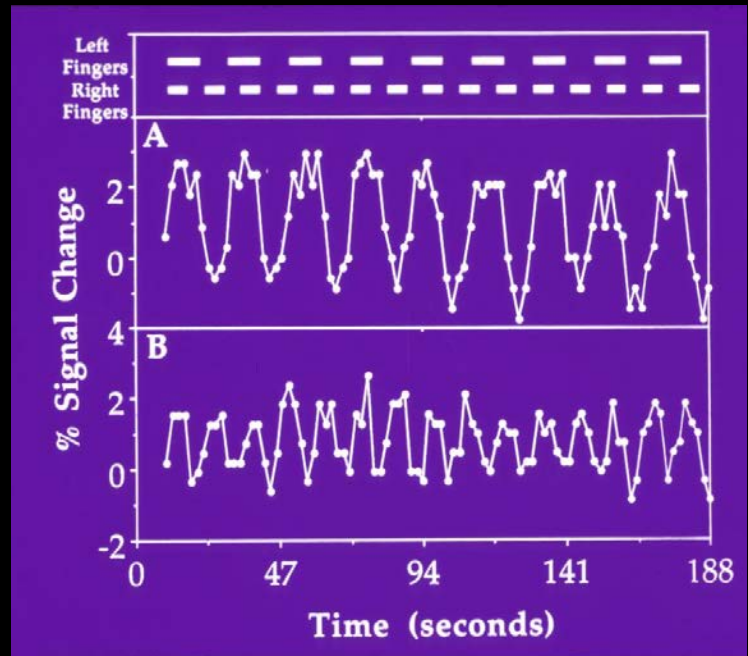
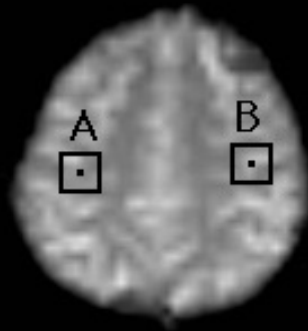

0.08 Hz

0.05 Hz

**spectral
density**

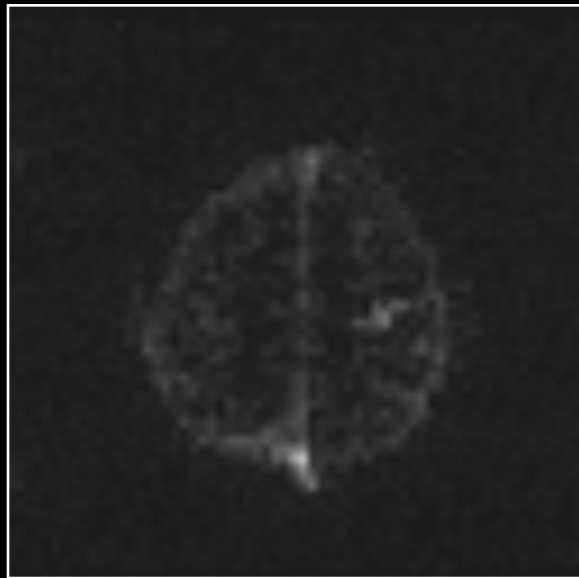

**c.c. > 0.5
with spectra**

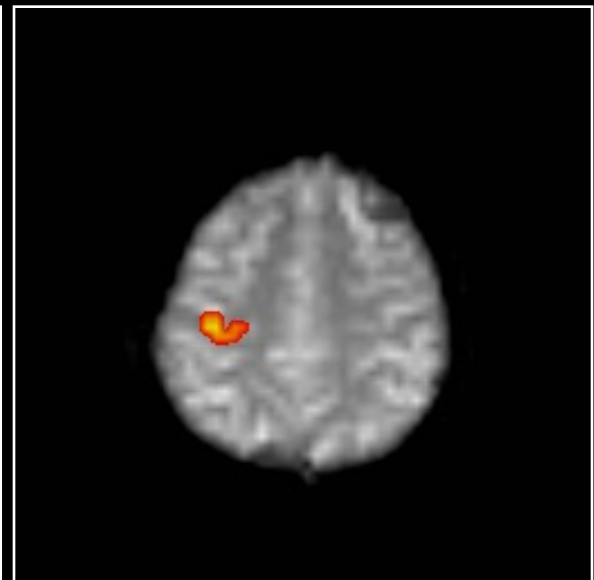
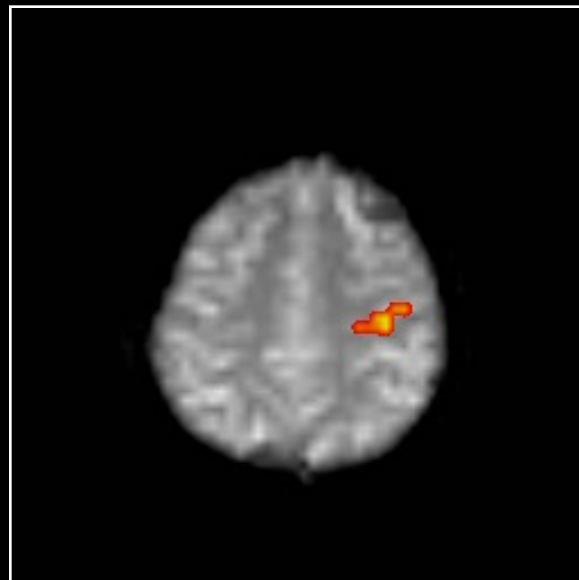

Neuronal Activation Input Strategies

1. Block Design

2. Frequency Encoding

3. Phase Encoding

4. Single Event

5. Orthogonal Block Design

6. Free Behavior Design.

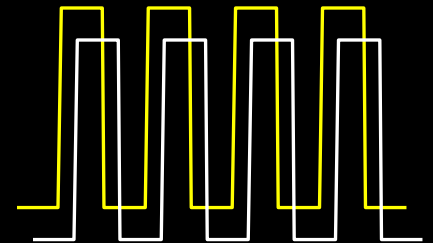
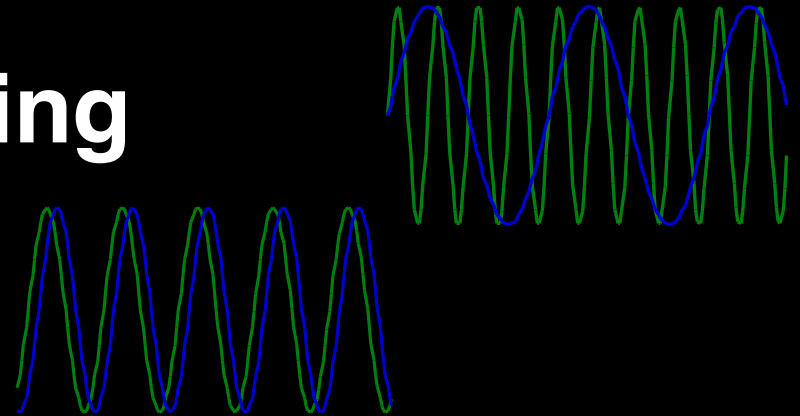

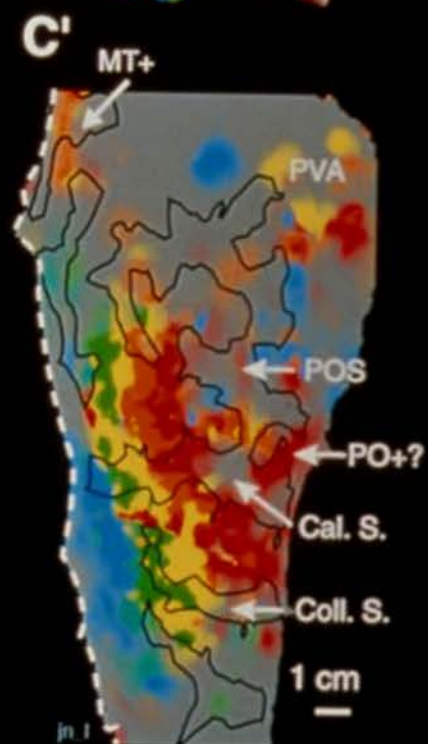
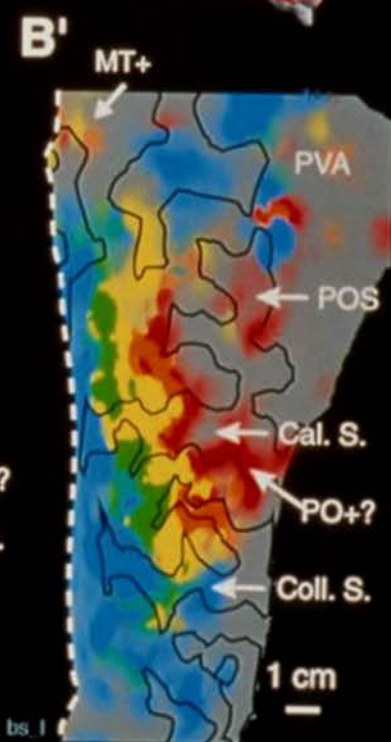
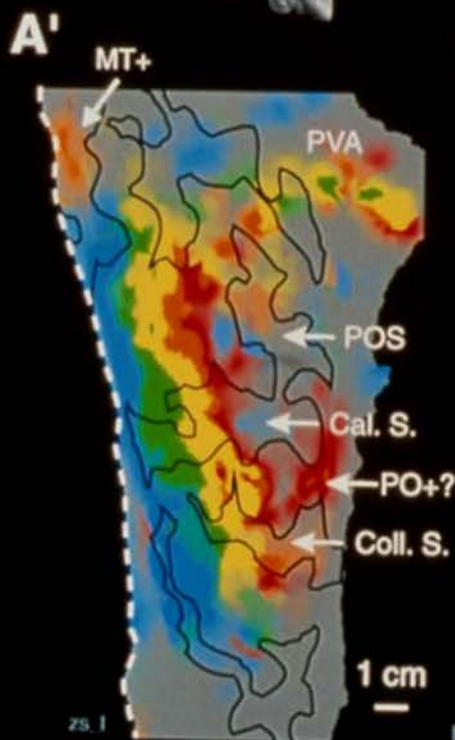
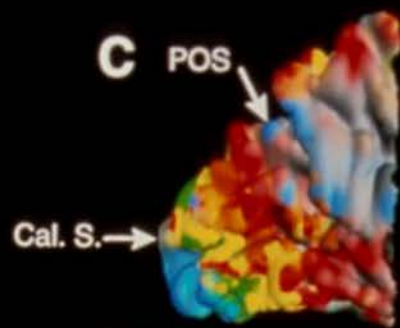
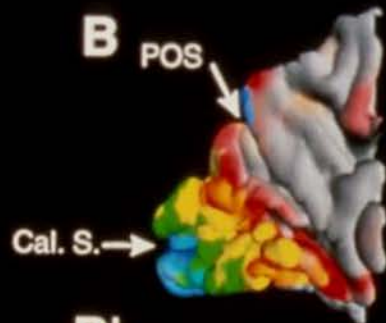
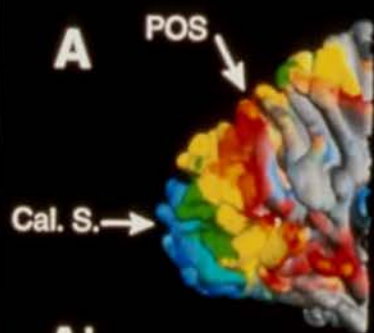

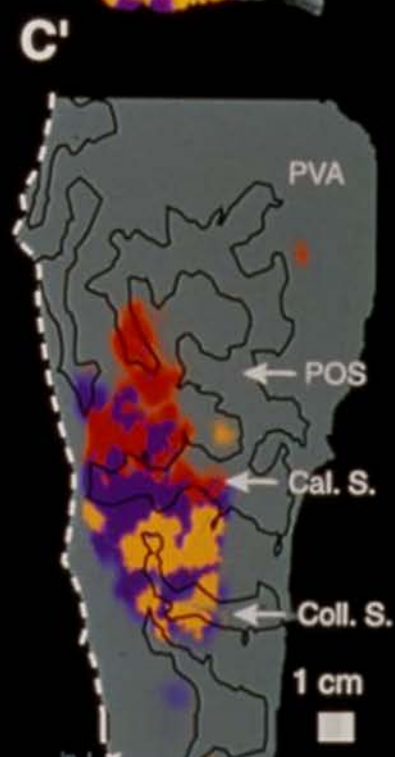
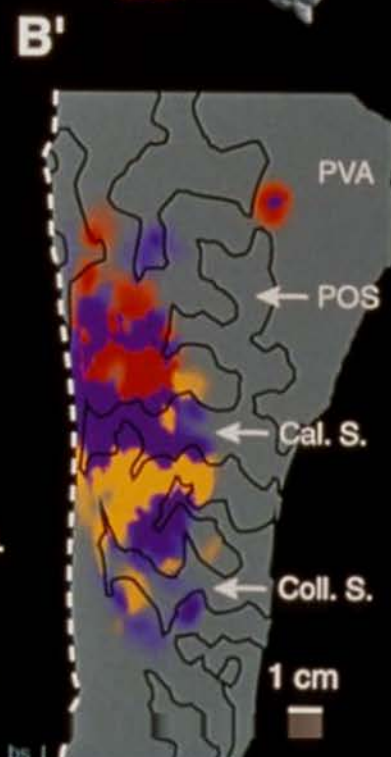
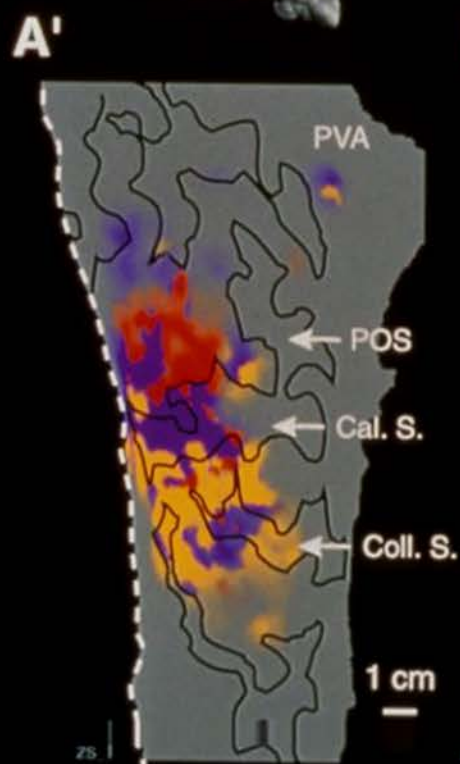
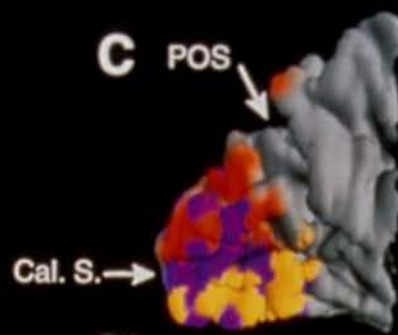
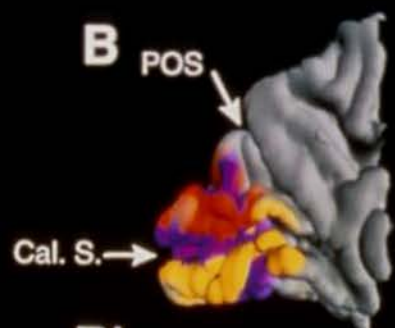
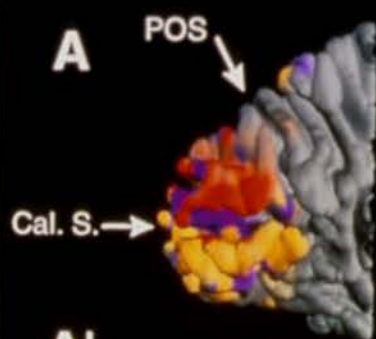
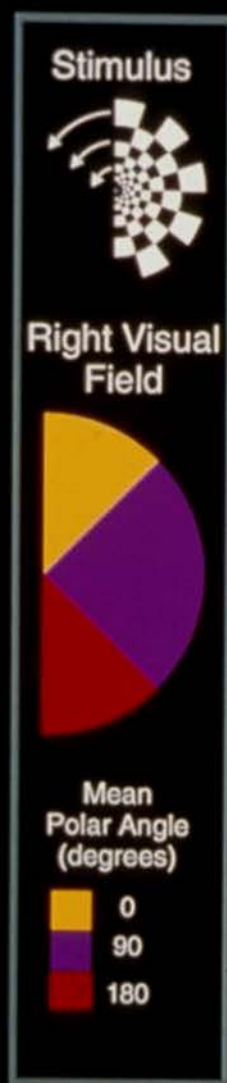

Neuronal Activation Input Strategies

1. Block Design

2. Frequency Encoding

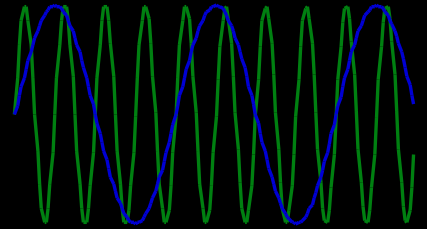

3. Phase Encoding

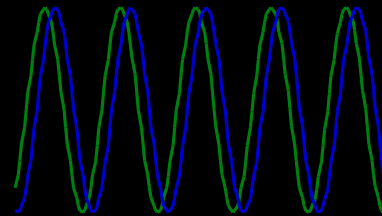

4. Single Event

5. Orthogonal Block Design

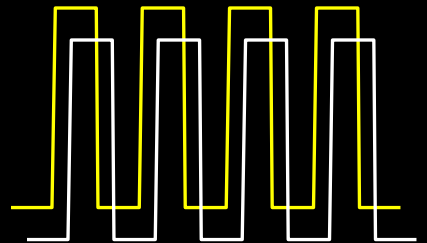

6. Free Behavior Design.

Detectability – constant ISI

SD – stimulus duration

ISI – inter-stimulus interval

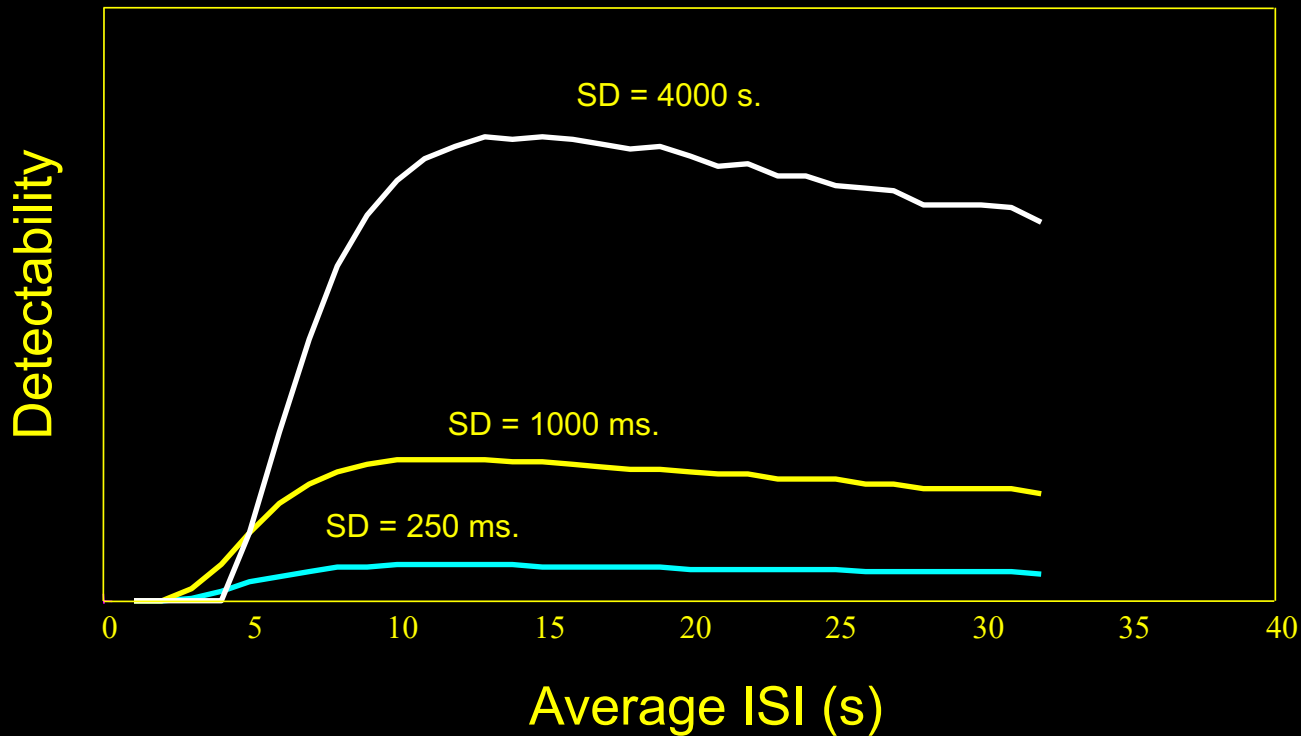
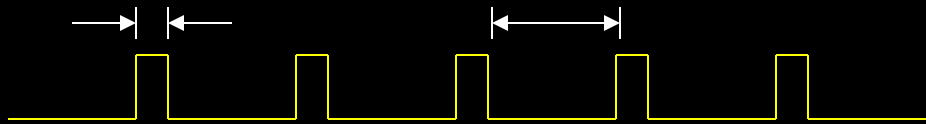

Visual Activation Paradigm: 1 , 2, & 3 Trials

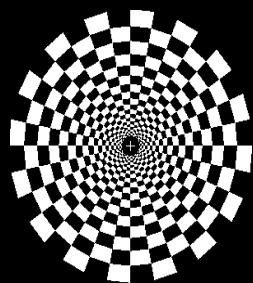

0 sec

20 sec

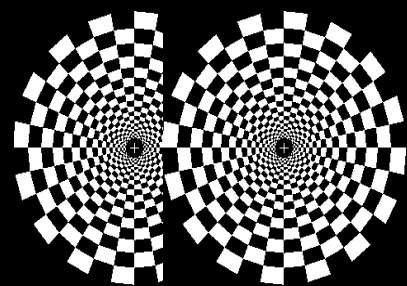

0 sec 2 sec

20 sec

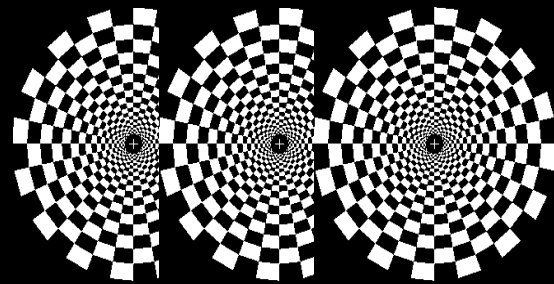

0 sec 2 sec 4 sec

20 sec

Response to Multiple Trials: Subject RW

RAW DATA

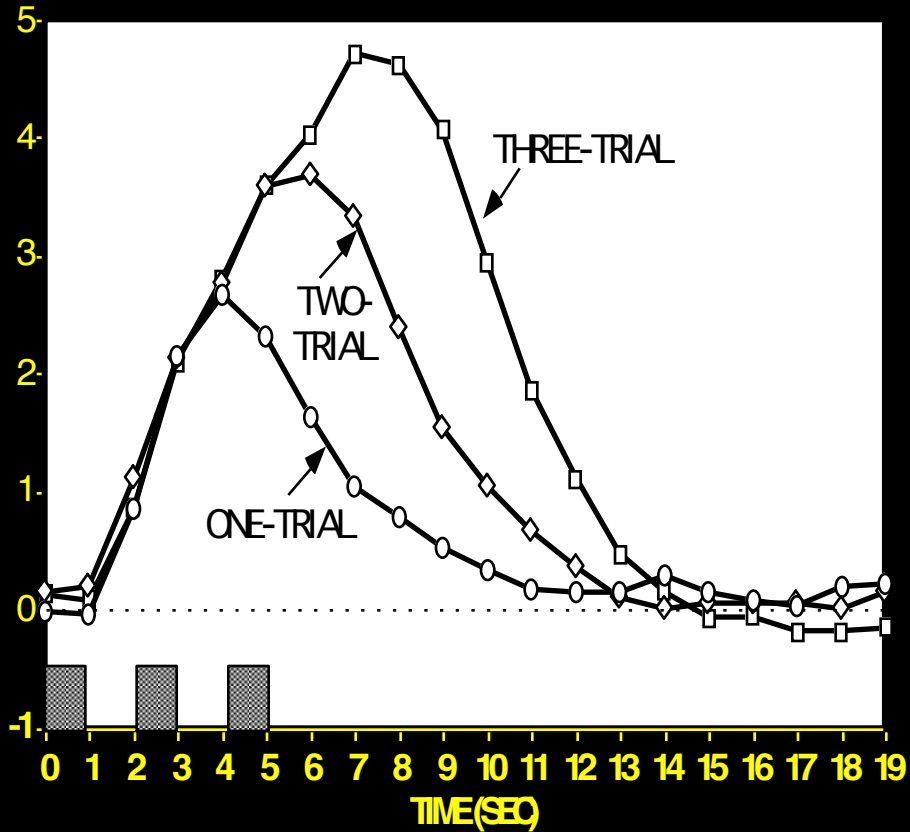

ESTIMATED RESPONSES

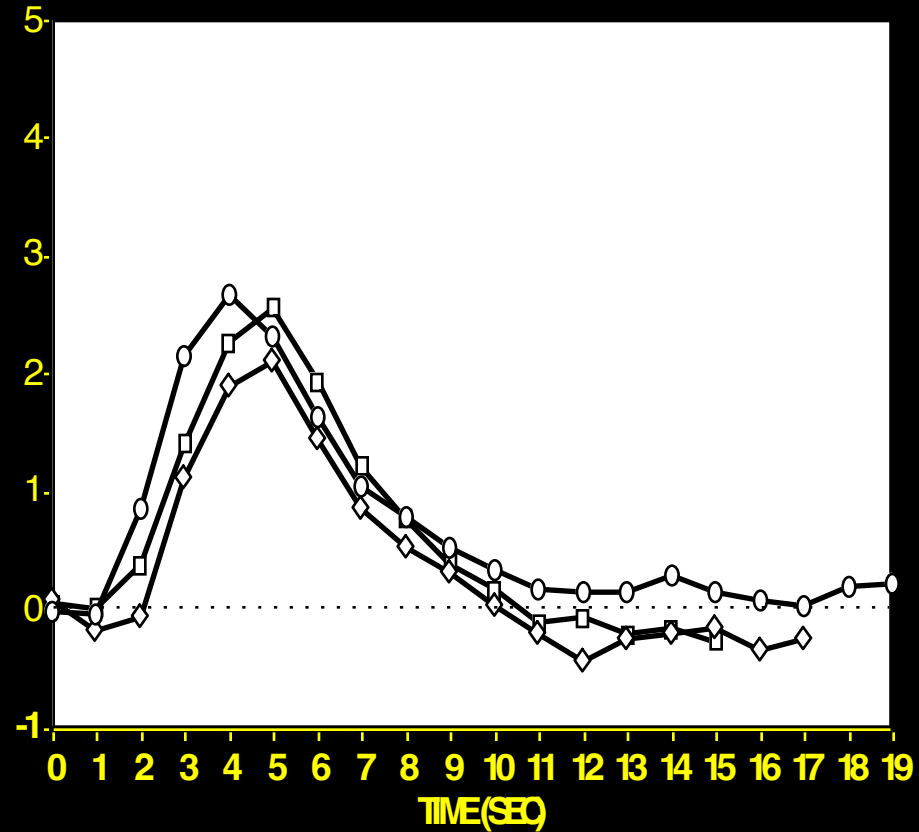

Detectability vs. Average ISI

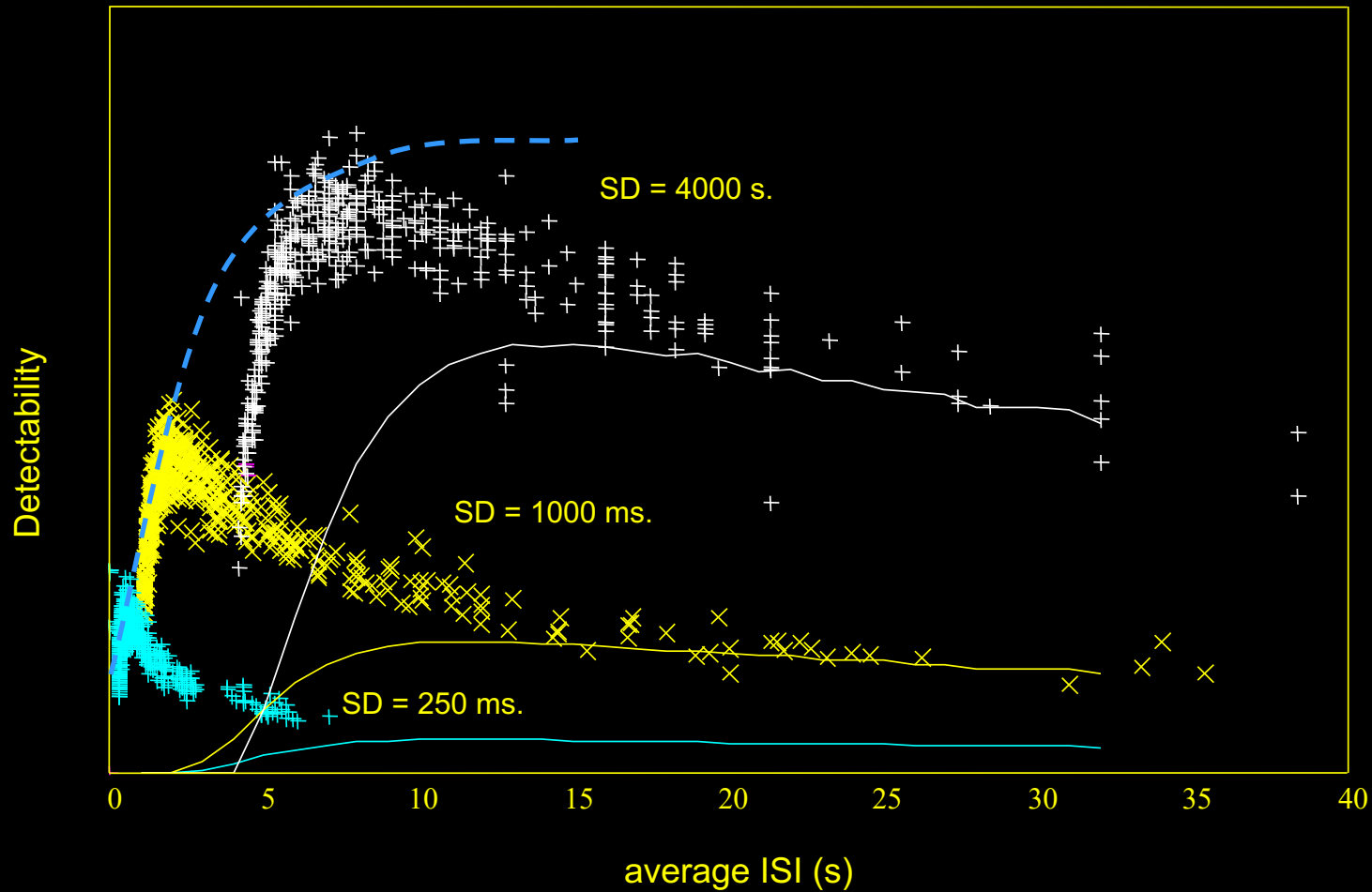

Estimation accuracy vs. average ISI

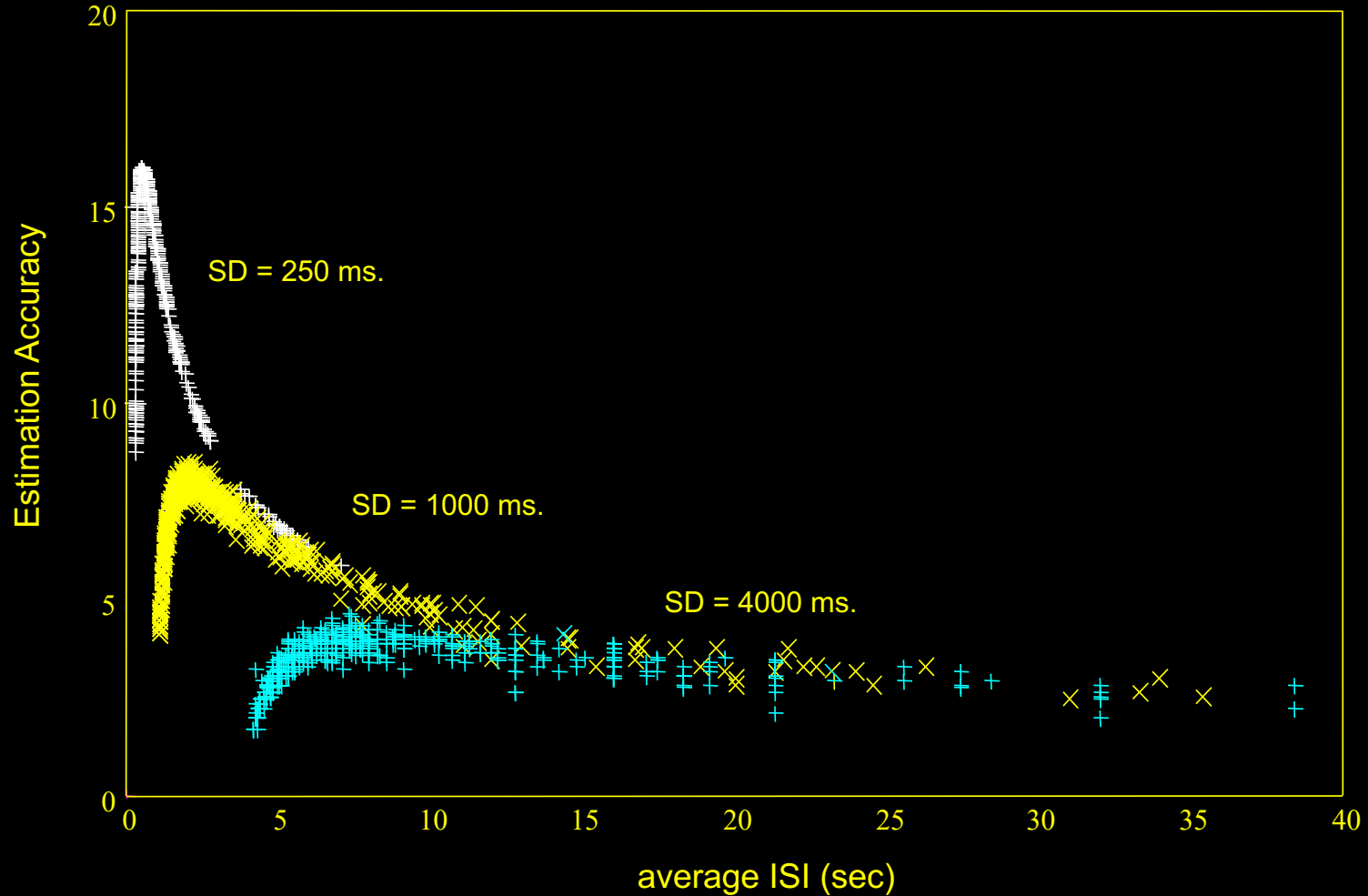

Speaking - Blocked Trial

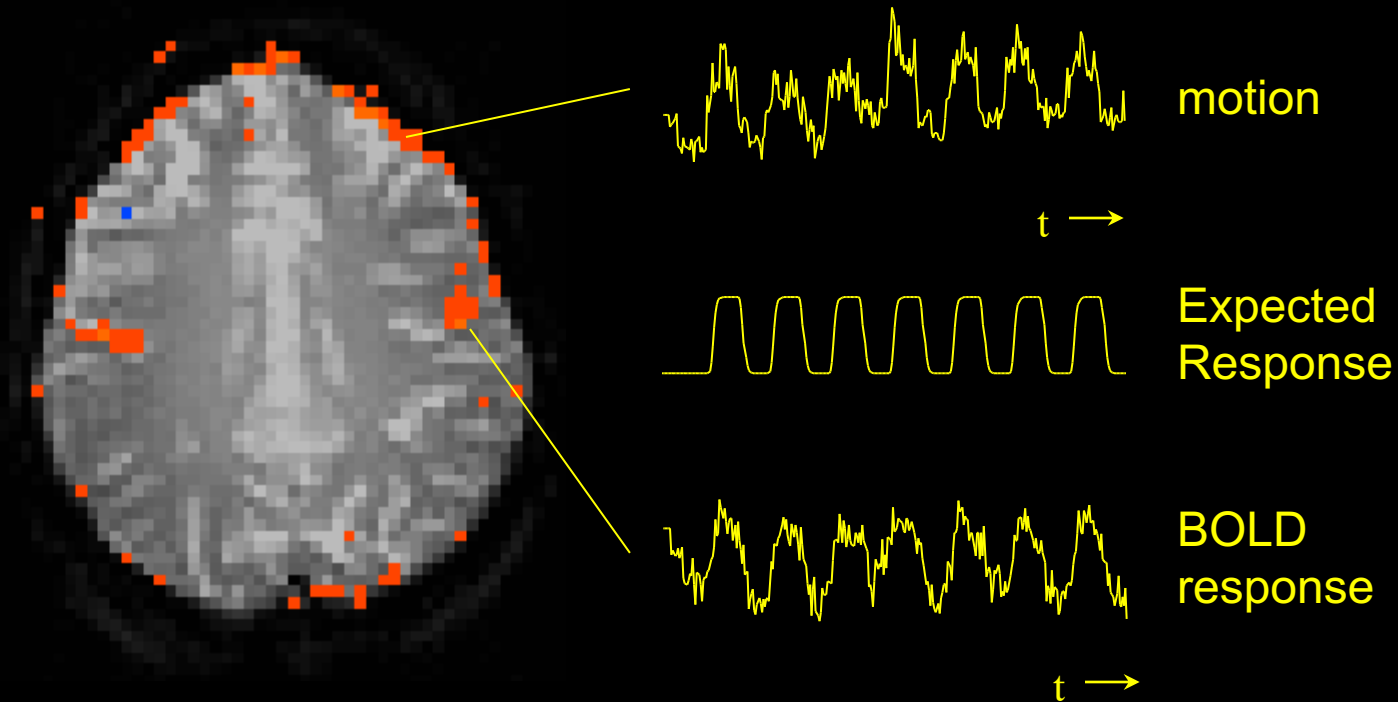

fMRI during tasks that involve brief motion

Blocked Design

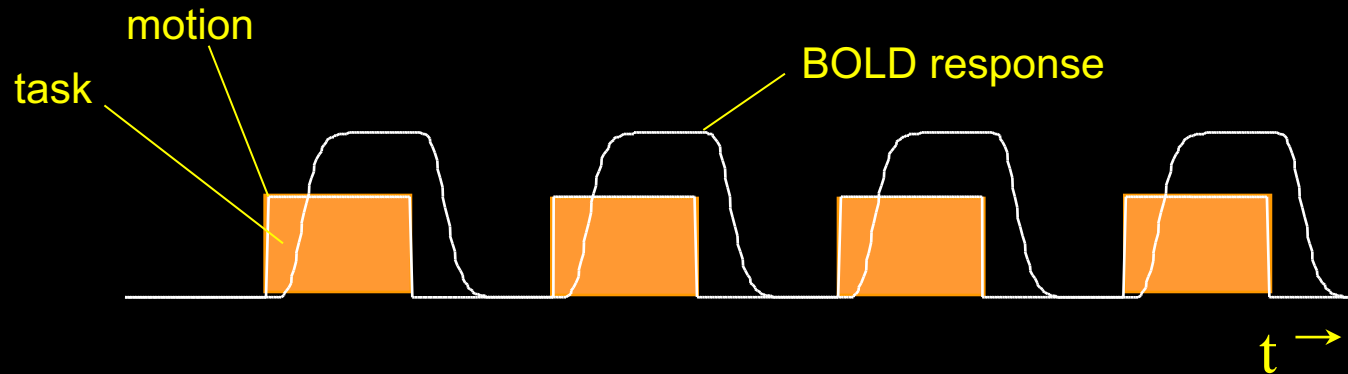

Event-Related Design

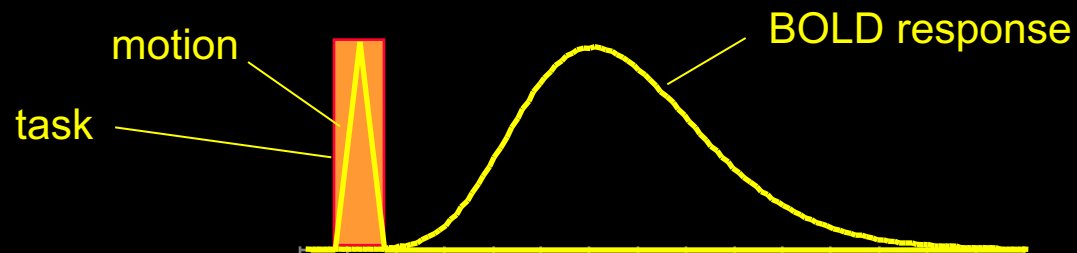

Overt Word Production

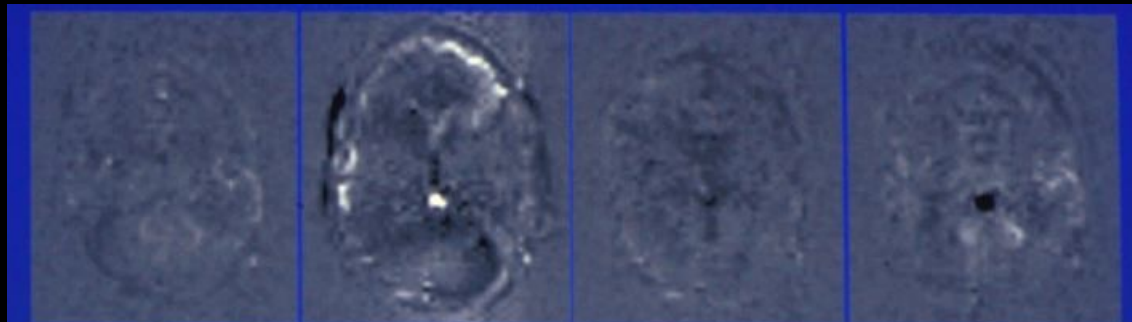

2

3

4

5



6

7

8

9

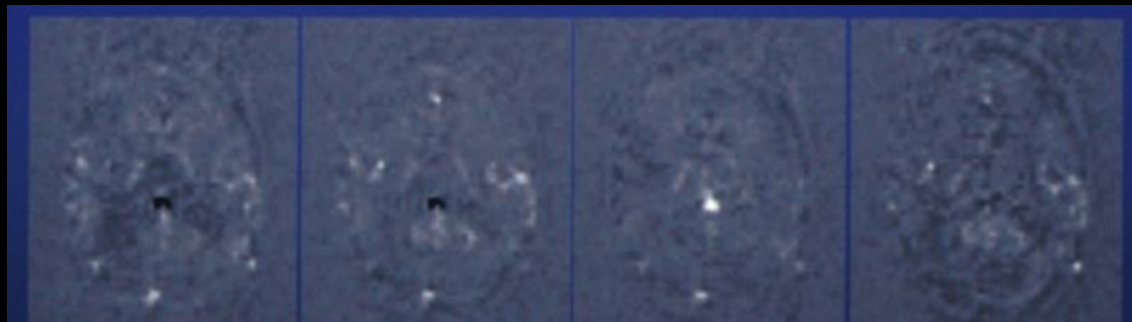

10

11

12

13

Motion-Decoupled fMRI: Functional MRI during of overt word production

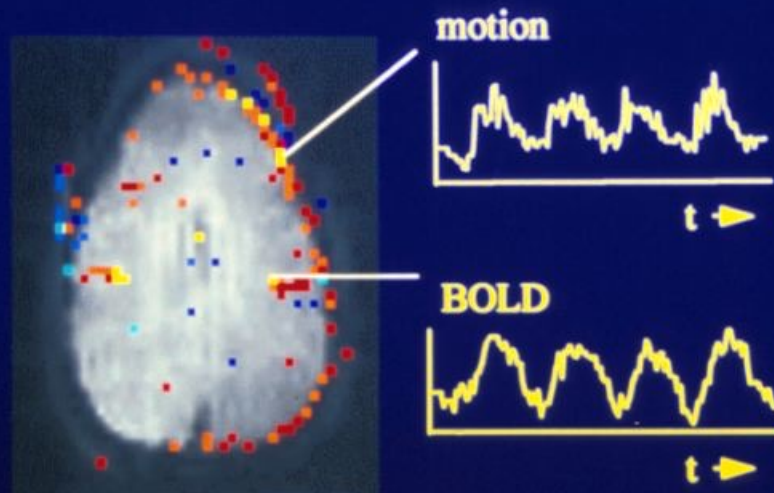

“block-trial” paradigm

Motion induced signal changes resemble functional (BOLD) signal changes

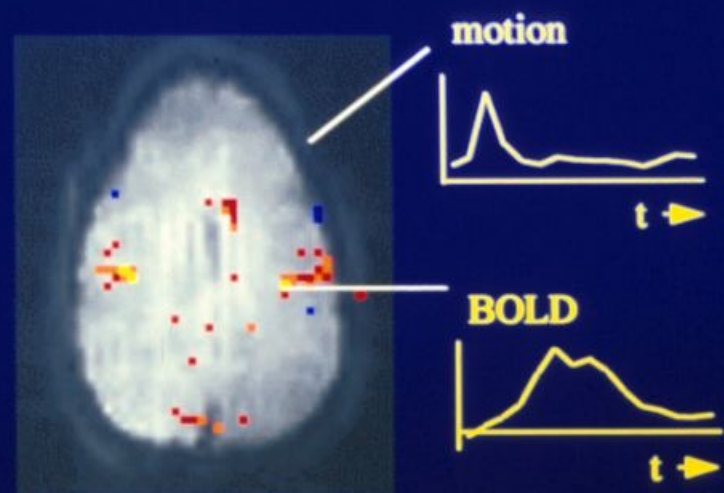

“single-trial” paradigm

Motion induced and BOLD signal changes are separated in time

R.M. Birn, et al.

Tongue Movement

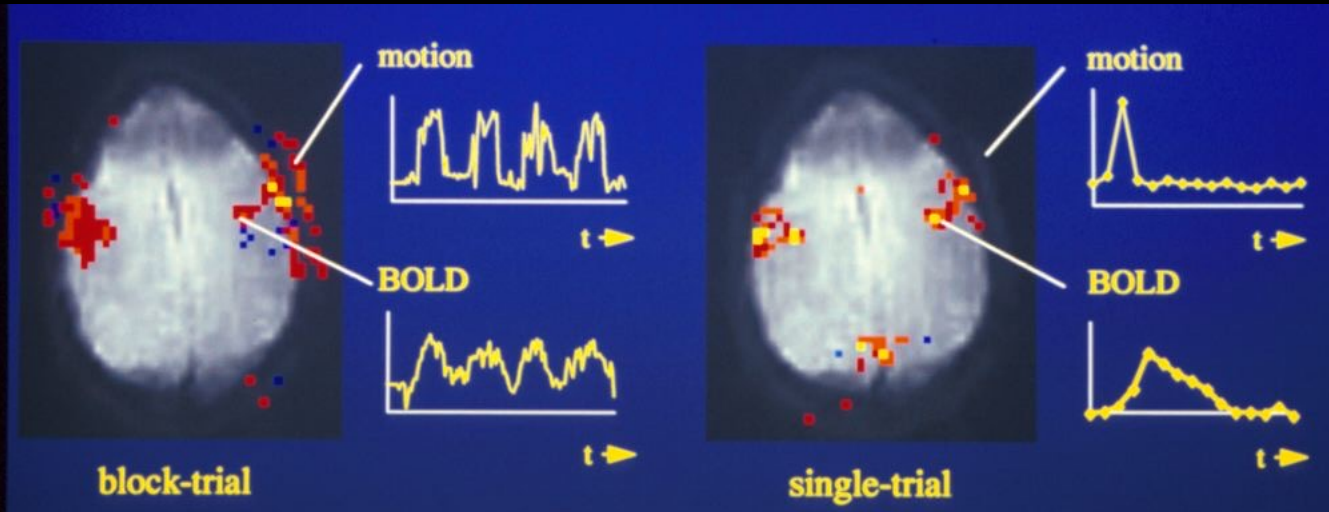

Jaw Clenching

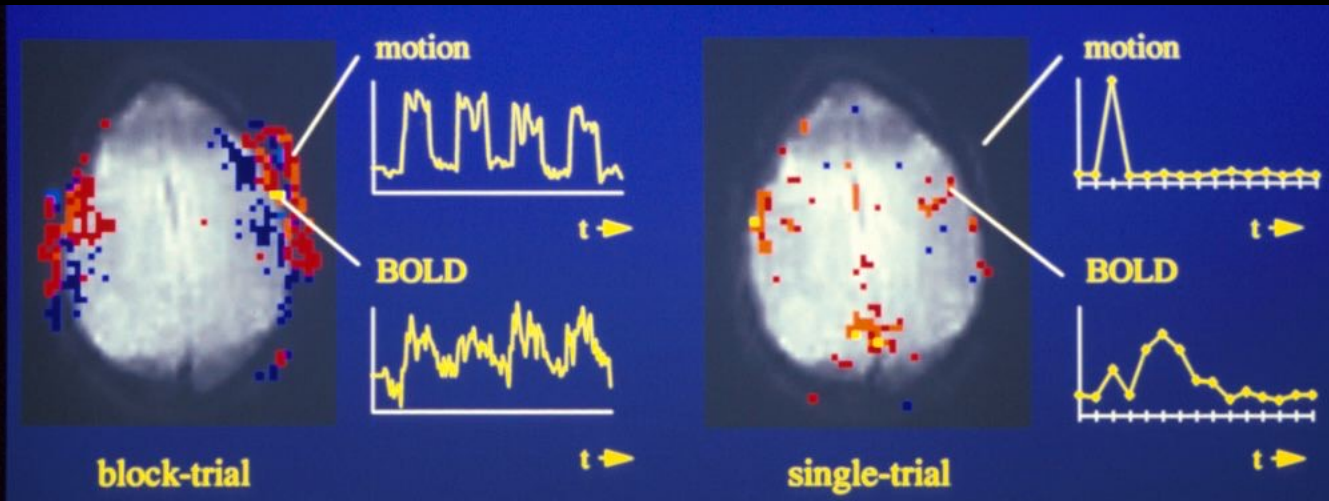

Constant ISI

Speaking - ER-fMRI

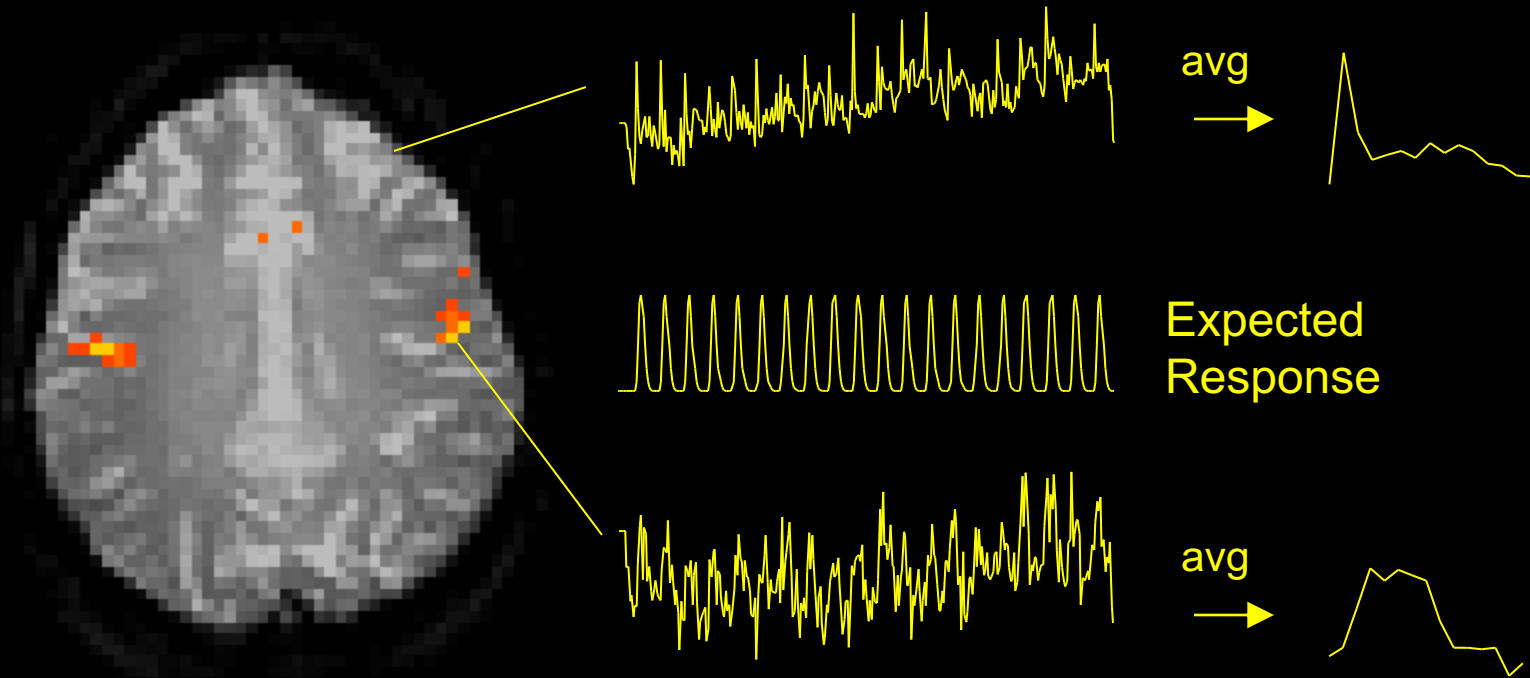

Swallowing - Event-Related

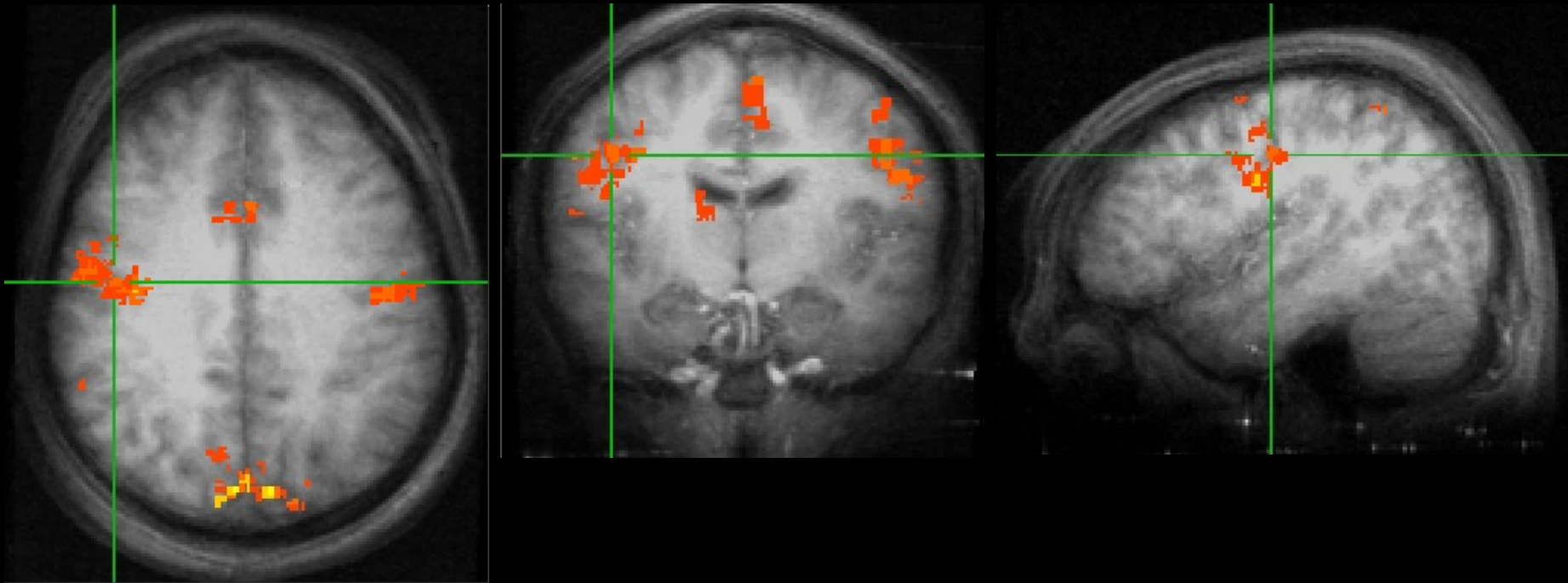

ODC Maps using fMRI

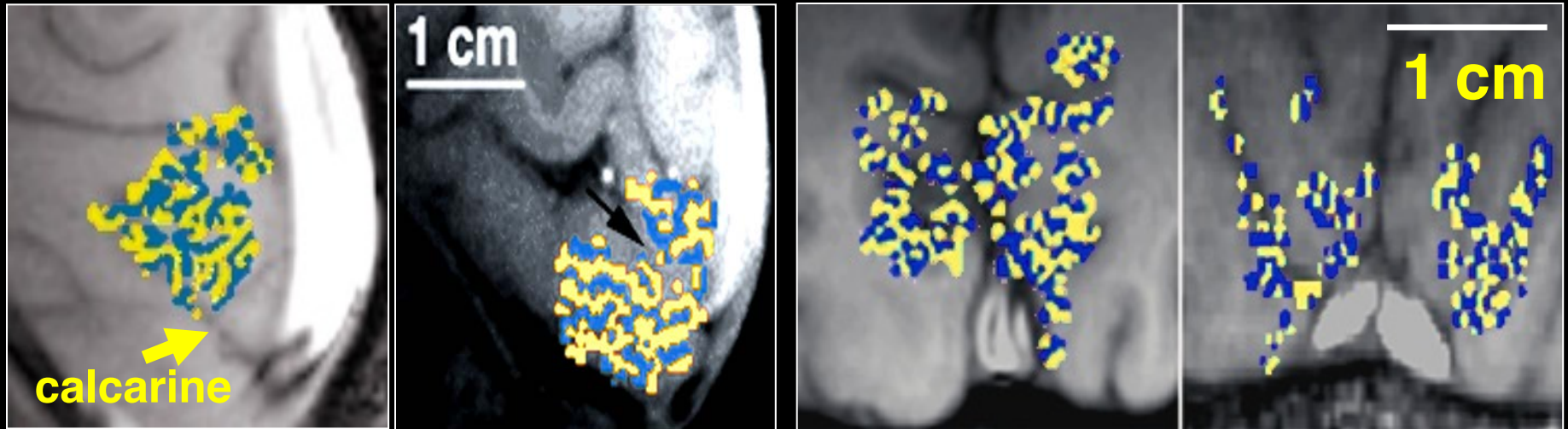

- Identical in size, orientation, and appearance to those obtained by optical imaging¹ and histology^{3,4}.

¹Malonek D, Grinvald A. *Science* 272, 551-4 (1996).

³Horton JC, Hocking DR. *J Neurosci* 16, 7228-39 (1996).

⁴Horton JC, et al. *Arch Ophthalmol* 108, 1025-31 (1990).

Why short is better than long

The vascular response to prolonged neural stimulation

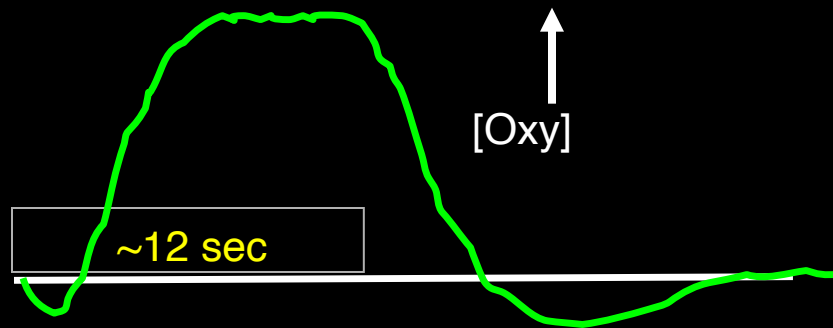

It is argued that fMRI cannot achieve submillimeter functional resolution because a saturated hyperoxic vascular response to neural activity spreads over many millimeters^{1,2}.

However, optical imaging has demonstrated that the hyperoxic response can yield well-localized maps when using short duration stimuli (<5 sec)¹.

The vascular response to brief neural stimulation

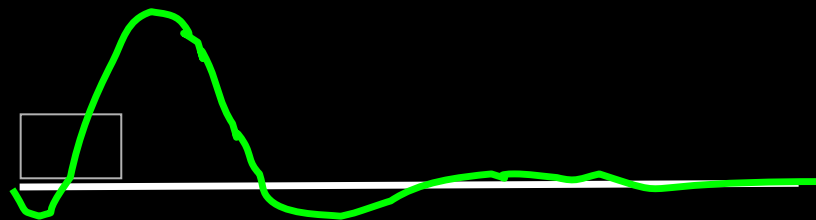

¹Malonek D, Grinvald A. Science 272, 551-4 (1996).

²Kim D-S, Duong T, Kim S-G. Nat Neurosci 3, 164-9 (2000).

Neuronal Activation Input Strategies

1. Block Design

2. Frequency Encoding

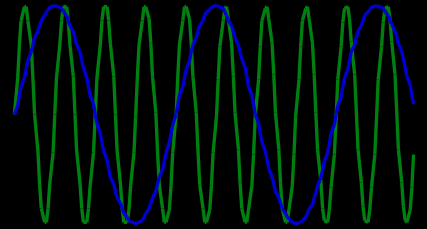

3. Phase Encoding

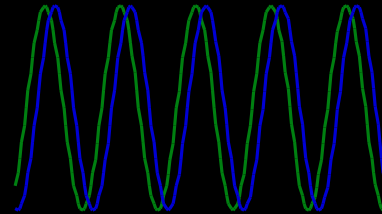

4. Single Event

5. Orthogonal Block Design

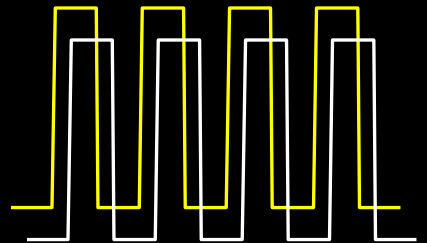

6. Free Behavior Design.

Example of a Set of Orthogonal Contrasts for Multiple Regression

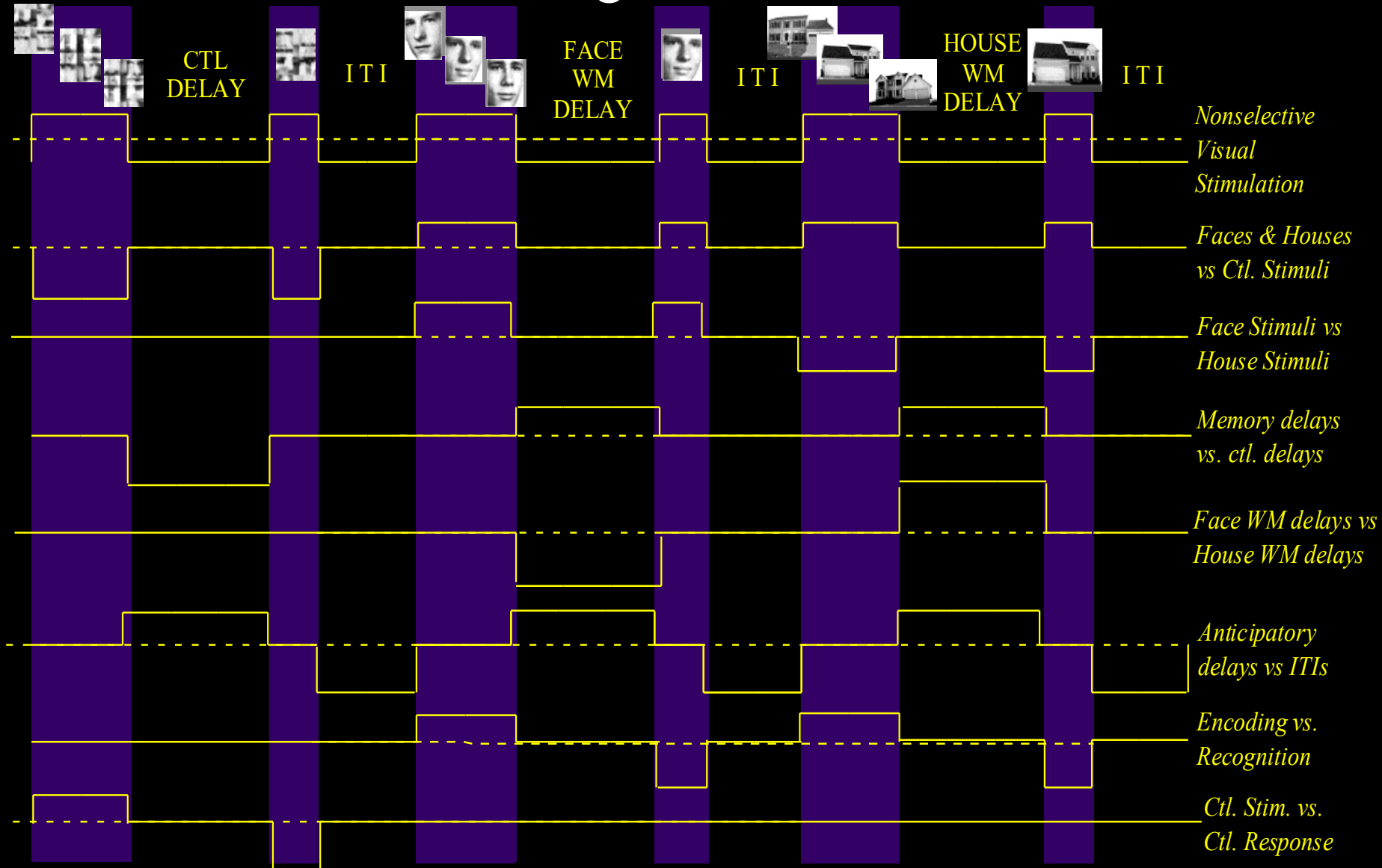

Neuronal Activation Input Strategies

1. Block Design

2. Frequency Encoding

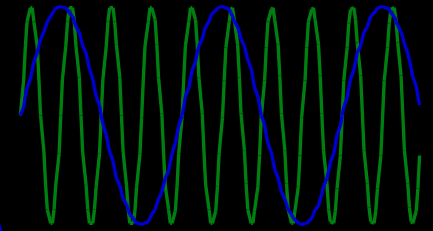

3. Phase Encoding

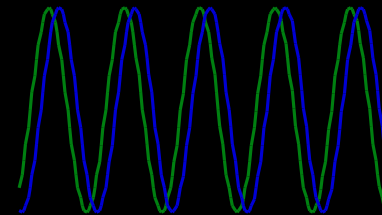

4. Single Event

5. Orthogonal Block Design

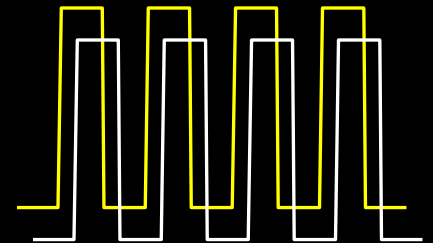

6. Free Behavior Design.

Free Behavior Design

Use a continuous measure as a reference function:

- Task performance
- Skin Conductance
- Heart, respiration rate..
- Eye position
- EEG

Resting Hemodynamic Autocorrelations

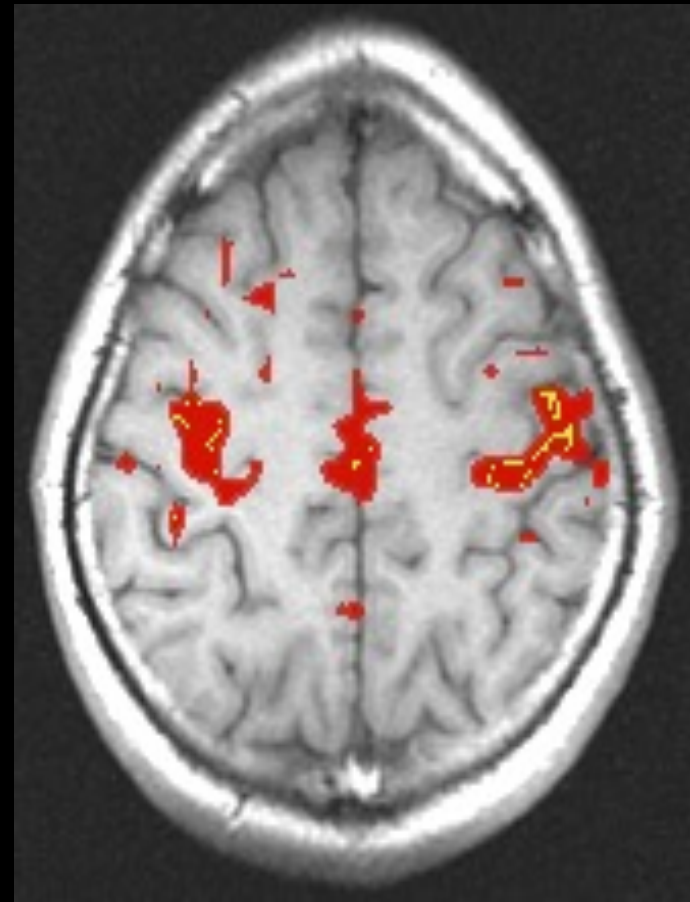
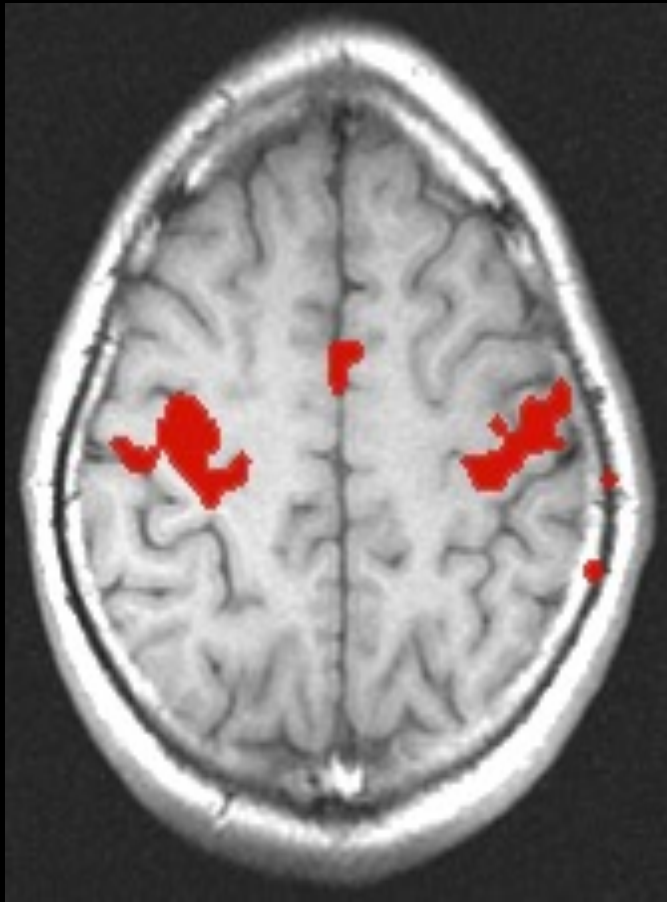

The Skin Conductance Response (SCR)

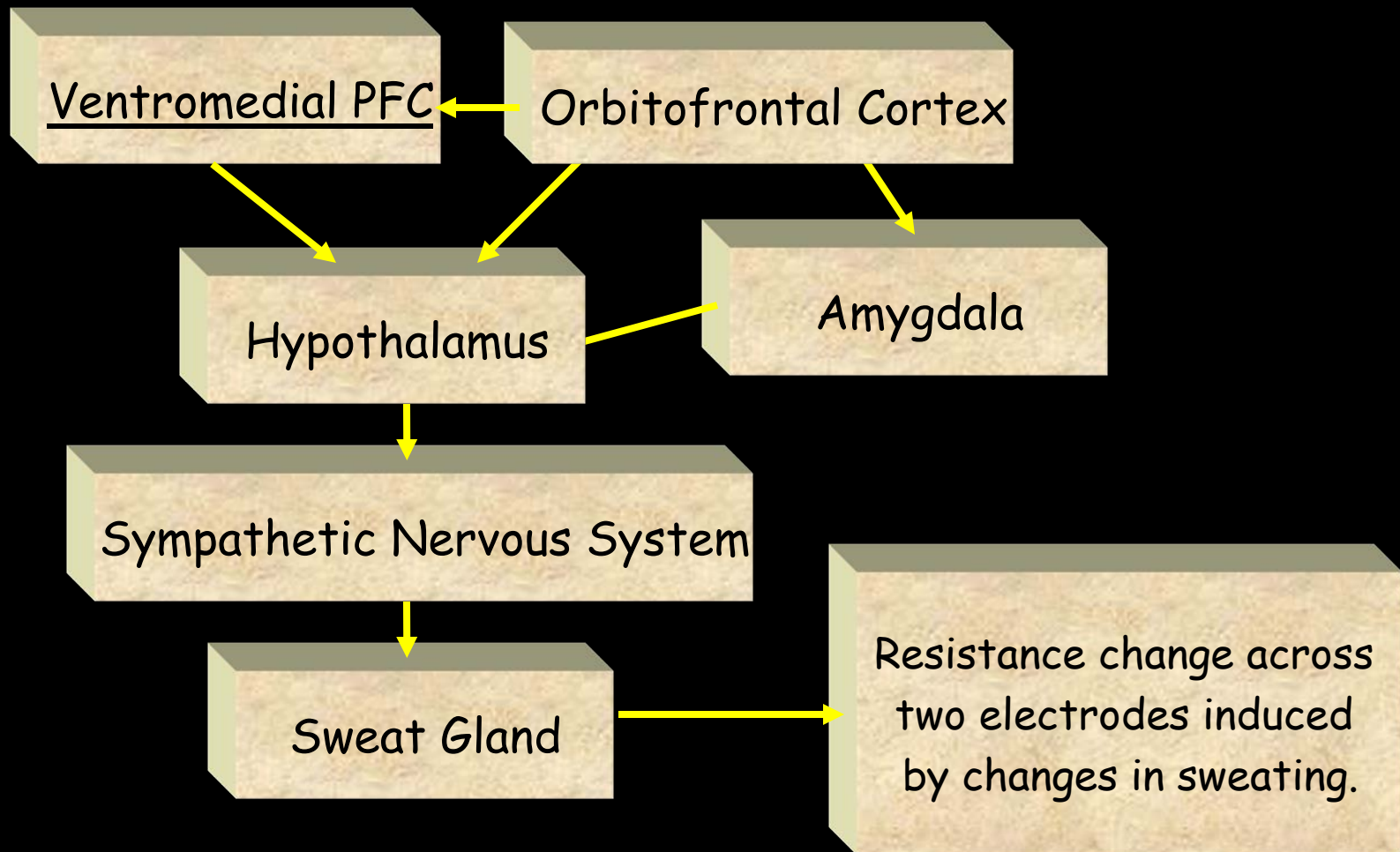

Skin Conductance Dynamics

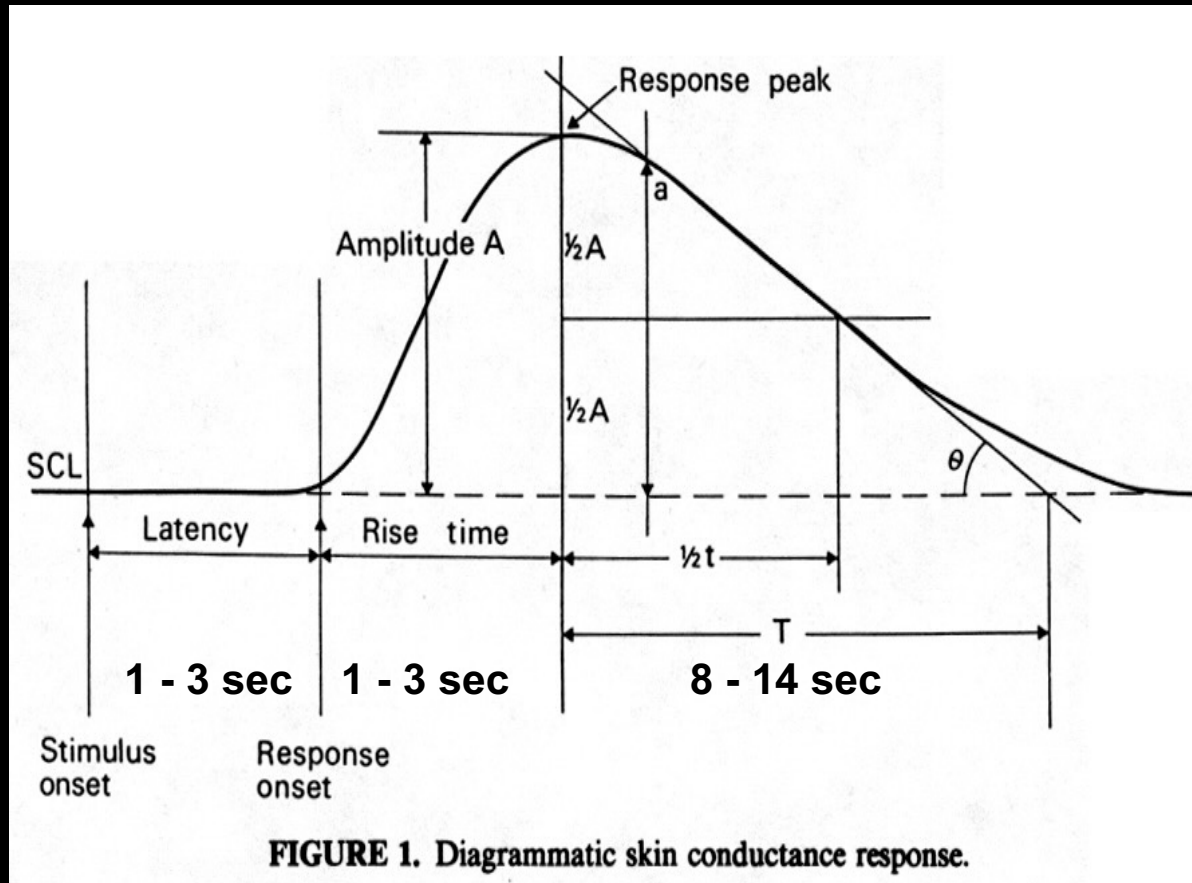

- Boucsein, Wolfram (1992). *Electrodermal Activity*. Plenum Press, NY
- Venables, Peter, (1991). *Autonomic Activity ANYAS 620:191-207.*

Brain activity correlated with SCR during “Rest”

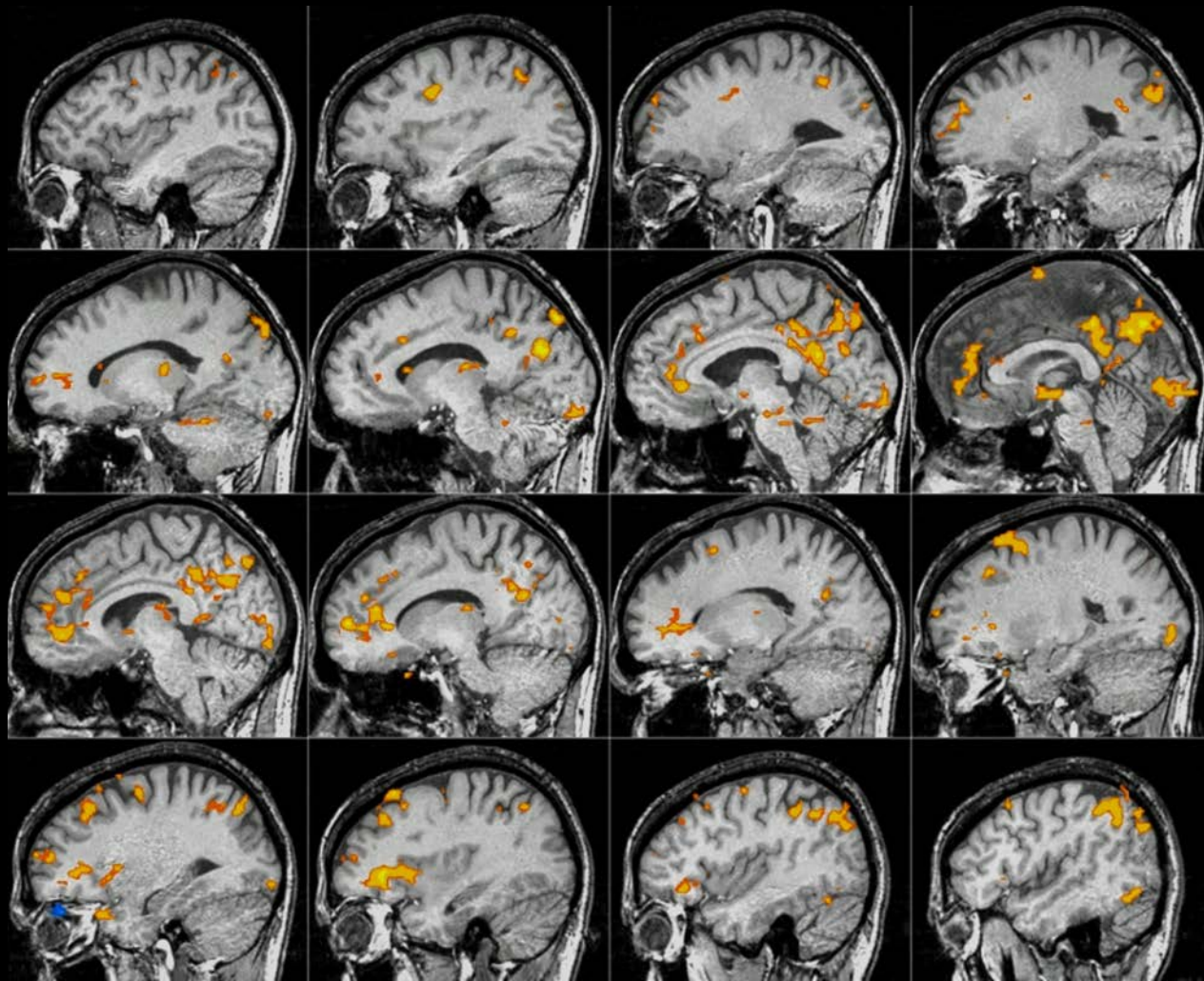

- **Contrast in fMRI**

Hemodynamic Specificity

- **The Hemodynamic Transfer Function**

Location, Latency, Magnitude

- **Best Results So Far**

Temporal Resolution, Spatial Resolution

- **Neuronal Activation Input Strategies**

Block Design

Phase and Frequency Encoding

Orthogonal Designs

Parametric Designs

Event-Related Designs

Free Behavior Designs

Additional Thanks To...

Eric Wong, UCSD

Robert Savoy, MGH

Richard Hoge, MGH

Randy Buckner, Wash. U.

Ted DeYoe, MCW

Sue Courtney, Johns Hopkins U

Rasmus Birn, NIH

Ziad Saad, NIH

Patrick Bellgowan, NIH