

fMRI: Past, Present, and Future Limits of Spatial Resolution, Temporal Resolution and Interpretation

Peter A. Bandettini, Ph.D

Unit on Functional Imaging Methods
&
3T Neuroimaging Core Facility

Laboratory of Brain and Cognition
National Institute of Mental Health



Technology



Methodology

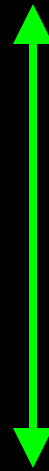
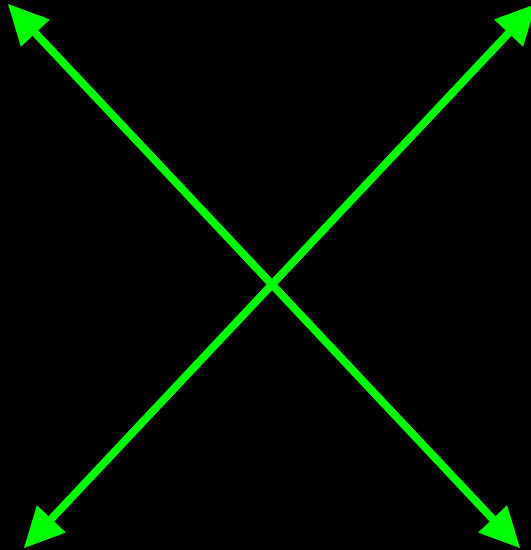
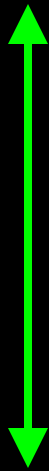

Interpretation



Applications

Technology

Methodology

Engineers

Statisticians

Physicists

Mathematicians

Neuroscientists

Physiologists

Clinicians

Interpretation

Applications

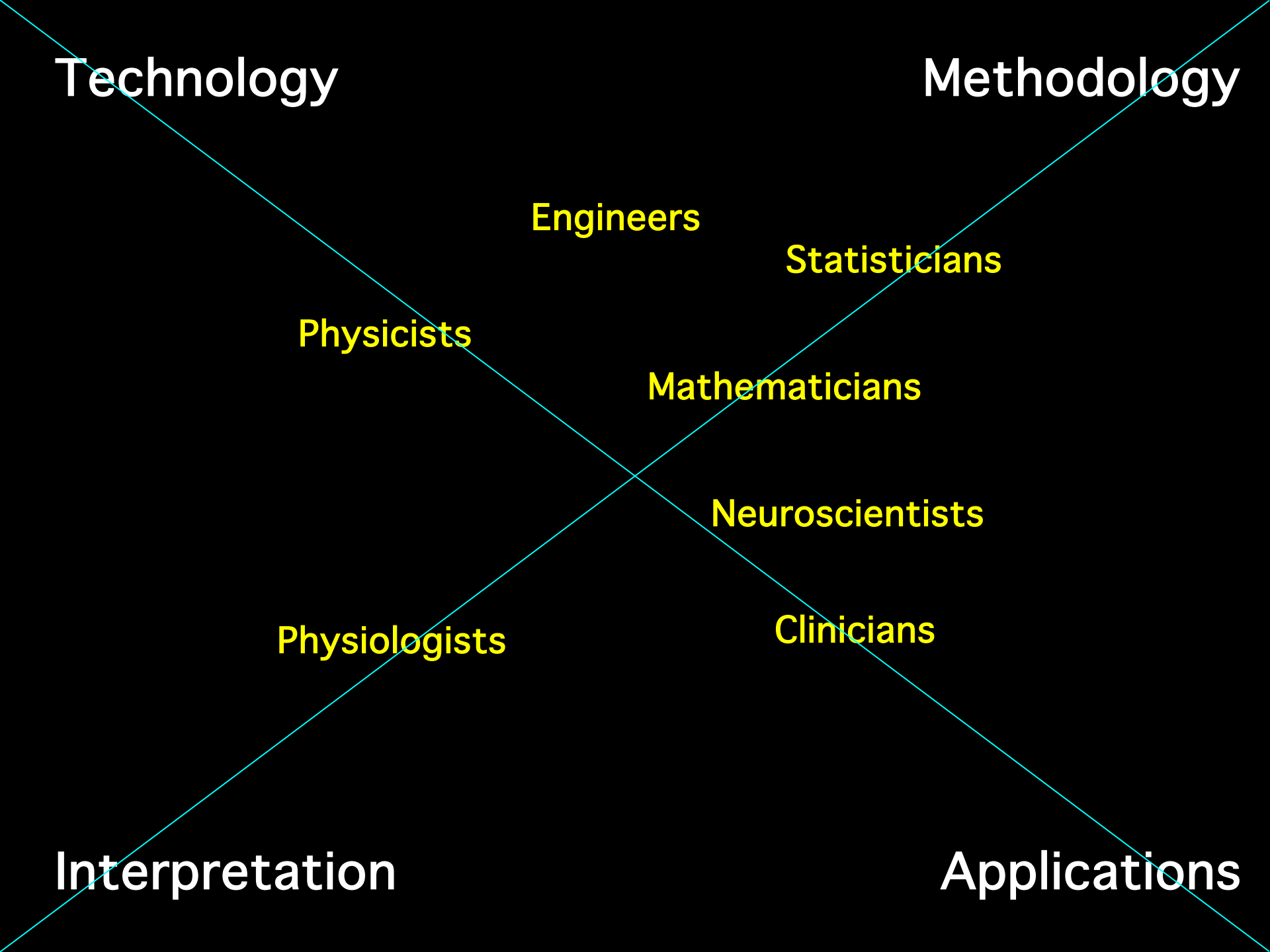

Technology

MRI
 EPI
 Local Human Head Gradient Coils
 BOLD
 ASL
 Spiral EPI
 Multi-shot fMRI
 1.5T,3T, 4T
 EPI on Clin. Syst.
 Nav. pulses
 Diff. tensor
 Real time fMRI
 Quant. ASL
 Dynamic IV volume
 Simultaneous ASL and BOLD
 Mg⁺
 Venography
 Z-shim
 Baseline Susceptibility
 7T
 >8 channels
 SENSE
 Current Imaging?

Methodology

Baseline Volume
 IVIM
 Correlation Analysis
 Parametric Design
 Surface Mapping
 Phase Mapping
 Linear Regression
 Event-related
 Motion Correction
 Multi-Modal Mapping
 ICA
 Free-behavior Designs
 Mental Chronometry
 Multi-variate Mapping
 Deconvolution
 Fuzzy Clustering
 CO₂ Calibration

Interpretation

Blood T2
 Hemoglobin
 BOLD models
 B₀ dep.
 TE dep
 SE vs. GE
 NIRS Correlation
 Veins
 PET correlation
 IV vs EV
 Pre-undershoot
 Resolution Dep.
 Post-undershoot
 CO₂ effect
 Inflow
 ASL vs. BOLD
 PSF of BOLD
 Extended Stim.
 Linearity
 Fluctuations
 Balloon Model
 Metab. Correlation
 Optical Im. Correlation
 Electrophys. correlation

Applications

Complex motor Language
 Imagery
 Memory
 Emotion
 Motor learning
 Children
 Tumor vasc.
 Drug effects
 BOLD -V1, M1, A1
 Presurgical
 Attention
 Ocular Dominance
 Volume - Stroke
 V1, V2..mapping
 Priming/Learning
 Clinical Populations
 Δ Volume-V1
 Plasticity
 Face recognition
 Performance prediction

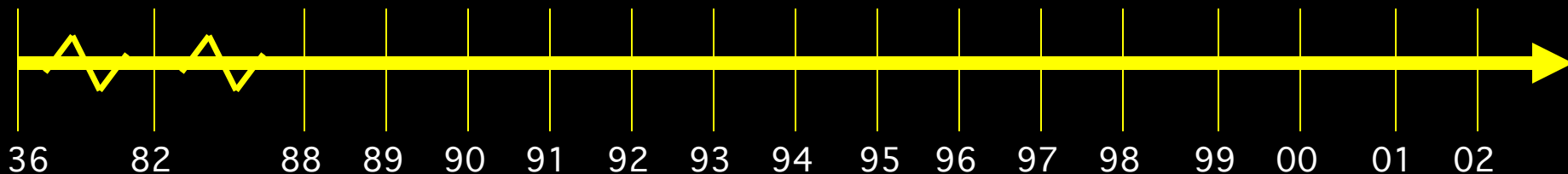



L. Pauling, C. D. Coryell, (1936) “The magnetic properties and structure of hemoglobin, oxyhemoglobin, and carbonmonoxyhemoglobin.” Proc.Natl. Acad. Sci. USA 22, 210-216.

Thulborn, K. R., J. C. Waterton, et al. (1982).“Oxygenation dependence of the transverse relaxation time of water protons in whole blood at high field.” Biochim. Biophys. Acta. 714: 265-270.

S. Ogawa, T. M. Lee, A. R. Kay, D. W. Tank, (1990) “Brain magnetic resonance imaging with contrast dependent on blood oxygenation.” Proc. Natl. Acad. Sci. USA 87, 9868-9872.

R. Turner, D. LeBihan, C. T. W. Moonen, D. Despres, J. Frank, (1991). Echo-planar time course MRI of cat brain oxygenation changes. Magn. Reson. Med. 27, 159-166.

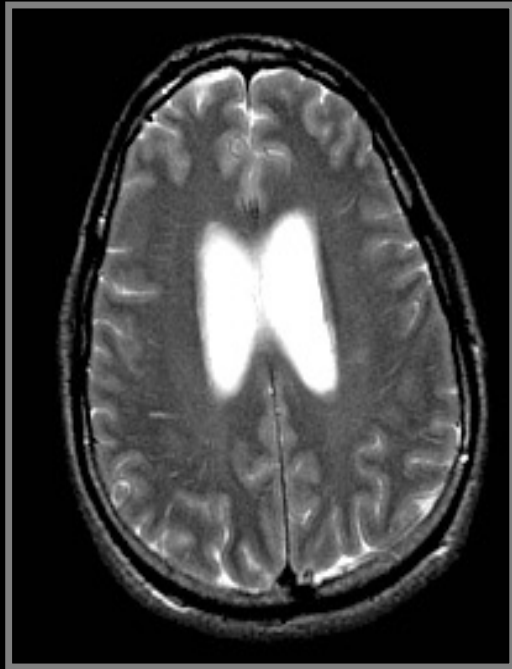

Anatomic

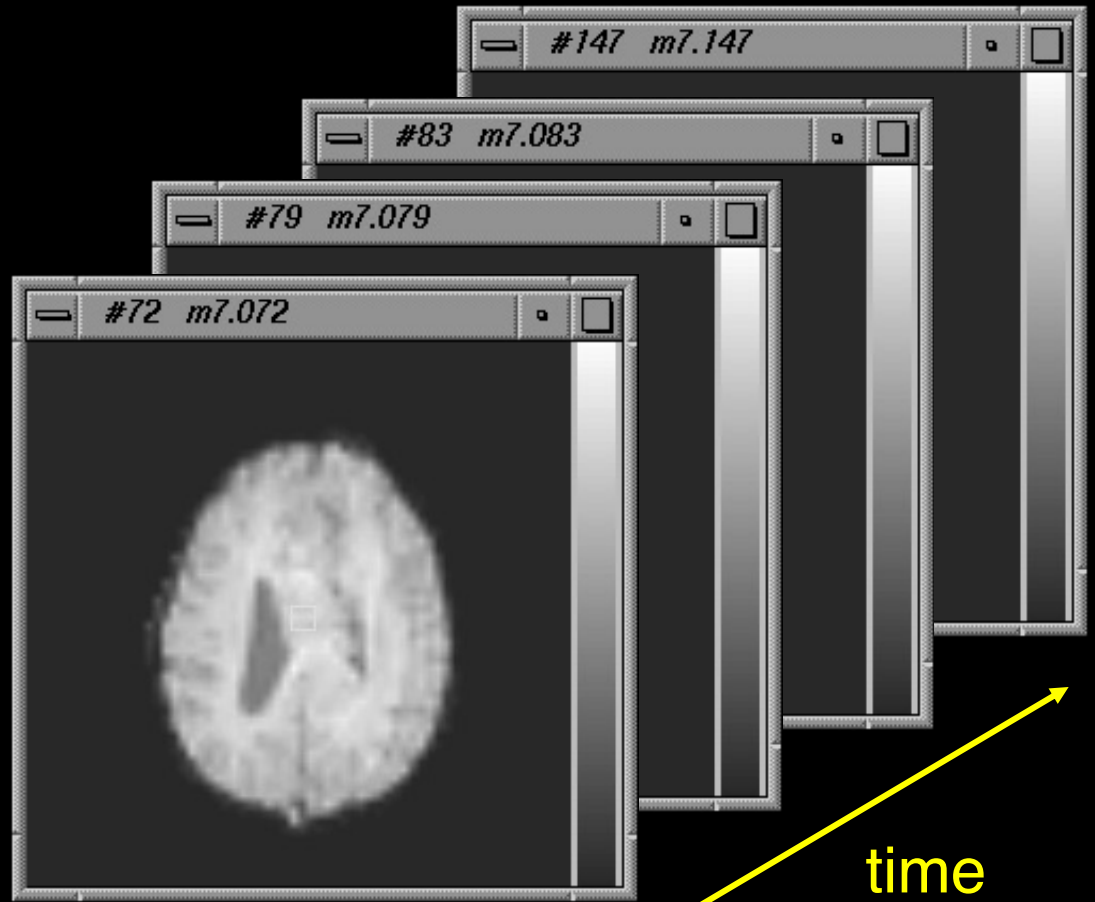

Functional

Single Shot EPI

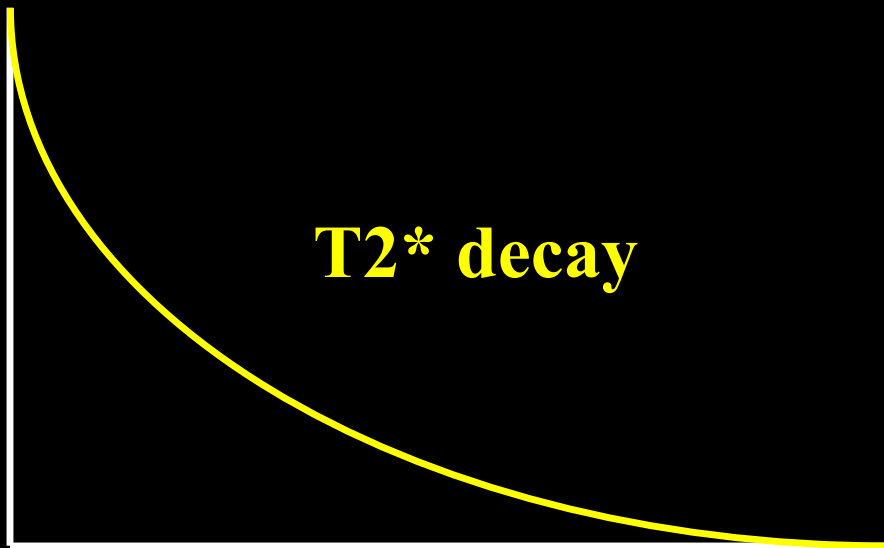

EPI Readout Window

≈ 20 to 40 ms

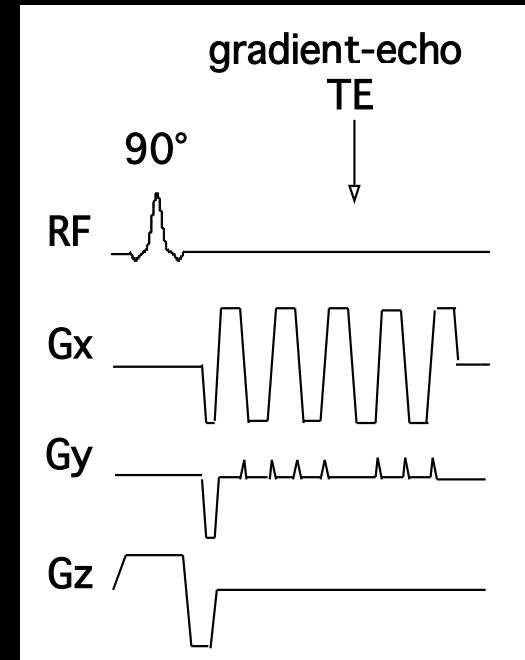

-
-
-
-
-
-
-
-

Imaging System Components

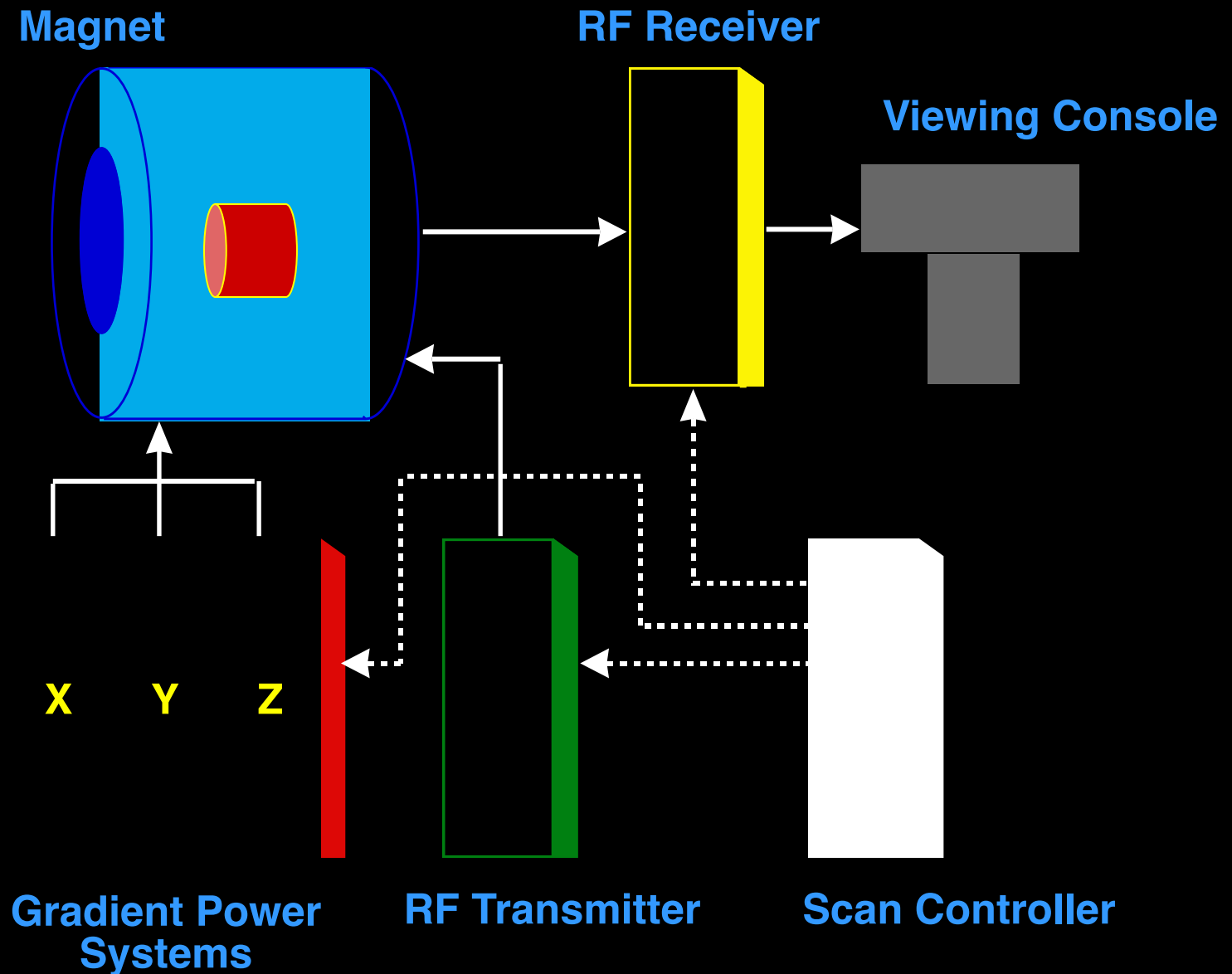

Local gradients solved the problem

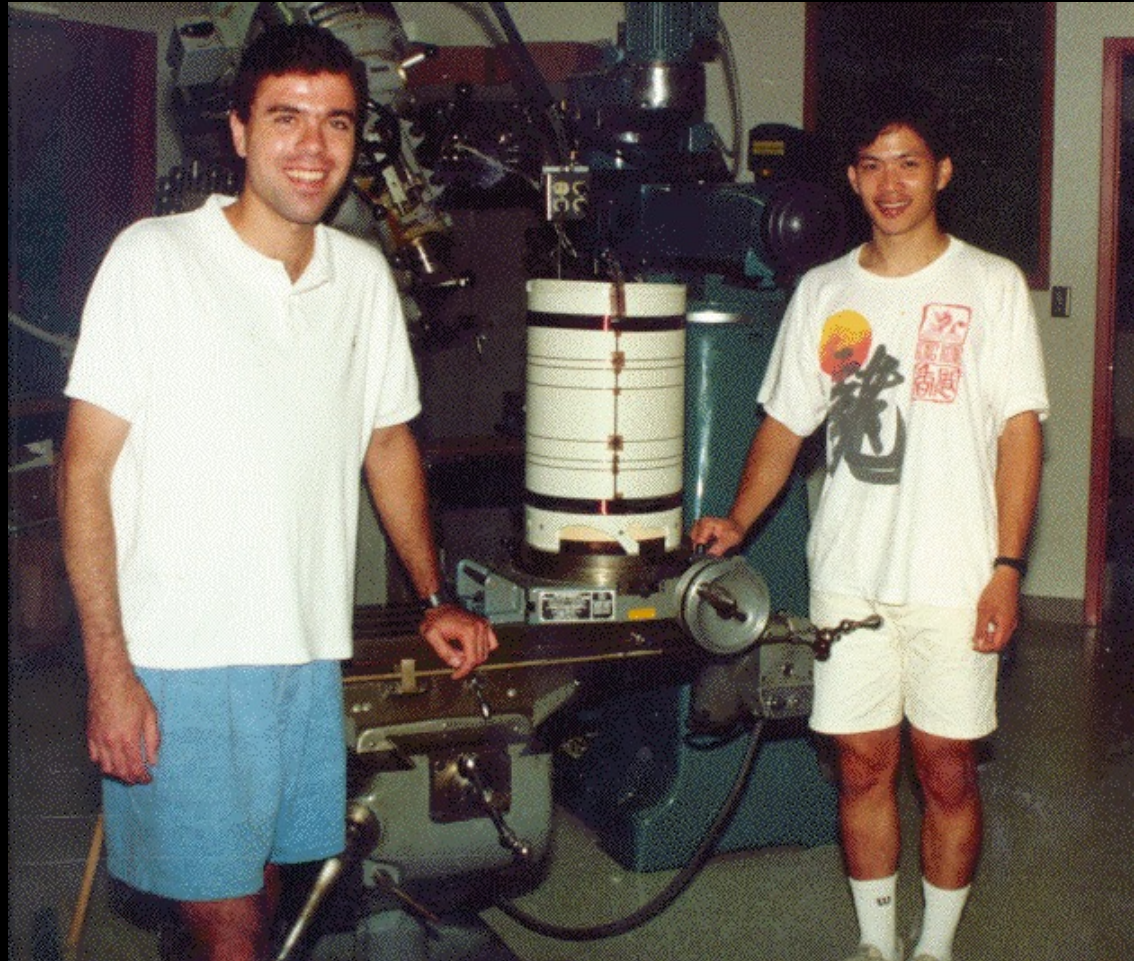

August, 1991

1991-1992



1992-1999



Imaging System Components

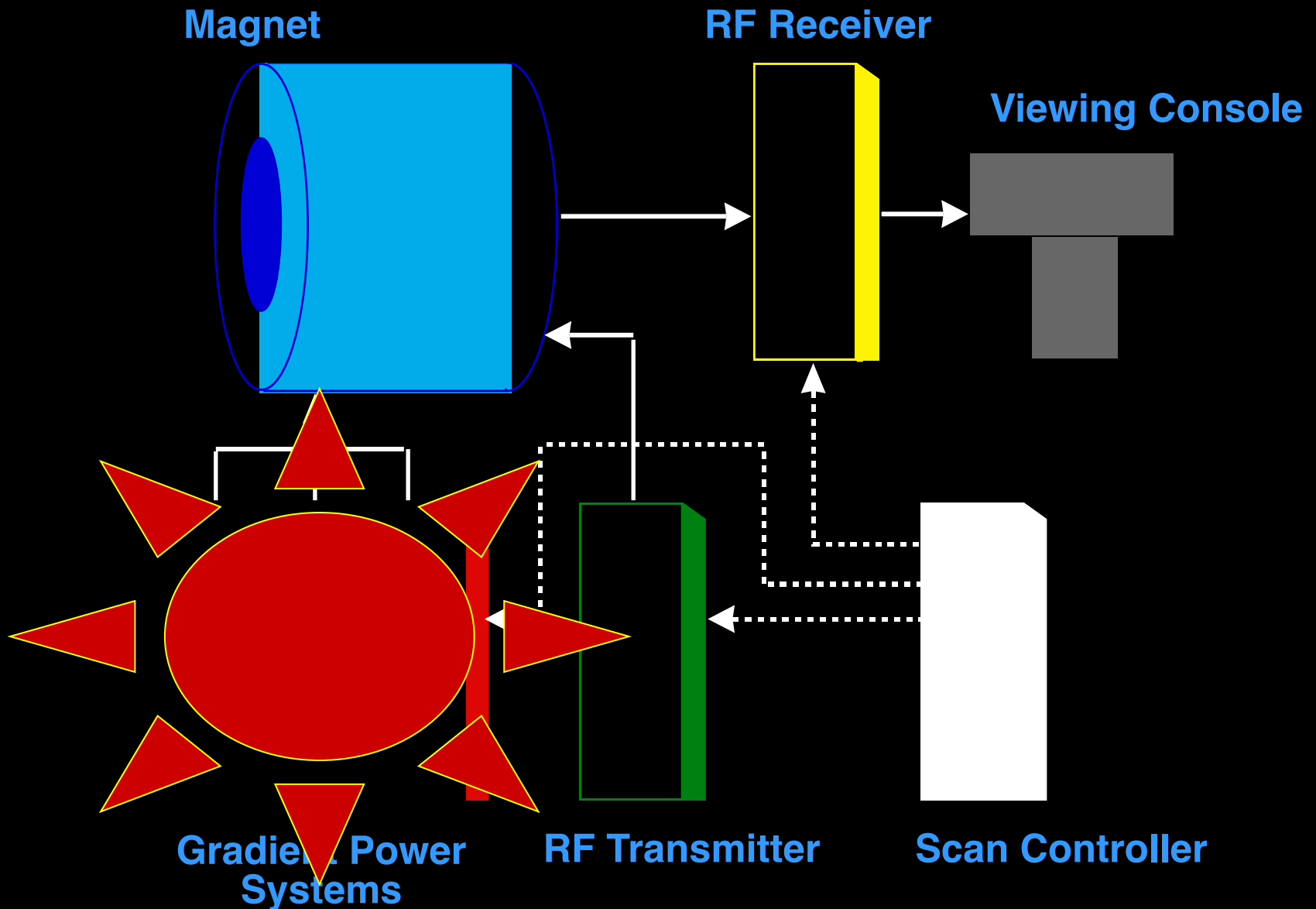

General Electric 3 Tesla Scanner



Functional MRI Methods

Blood Volume Imaging

BOLD Contrast

Arterial Spin Labeling

Blood Volume Imaging

Susceptibility Contrast agent bolus injection and time series collection of T2* or T2 - weighted images

Resting

Active

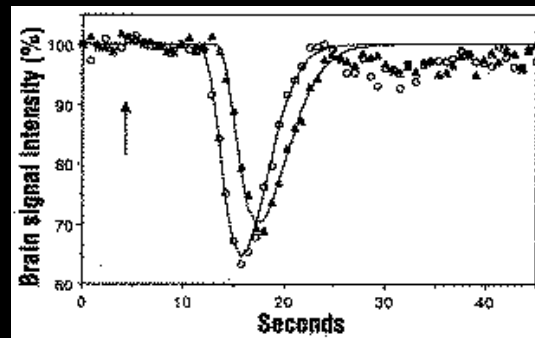
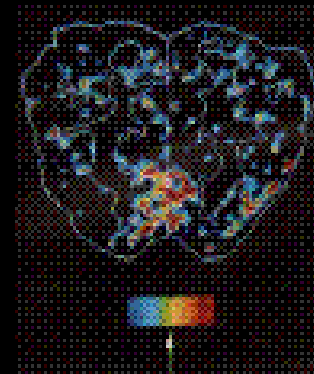
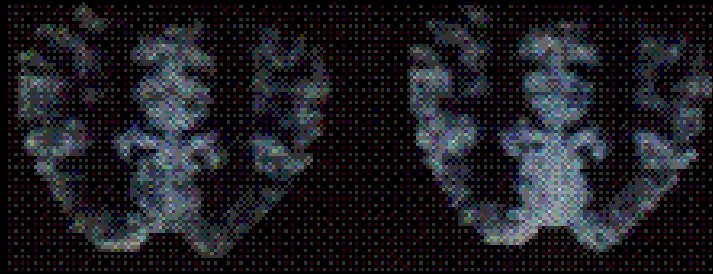

Blood Volume

**Photic
Stimulation**

**MRI Image showing
activation of the
Visual Cortex**

**From Belliveau, et al.
Science Nov 1991**

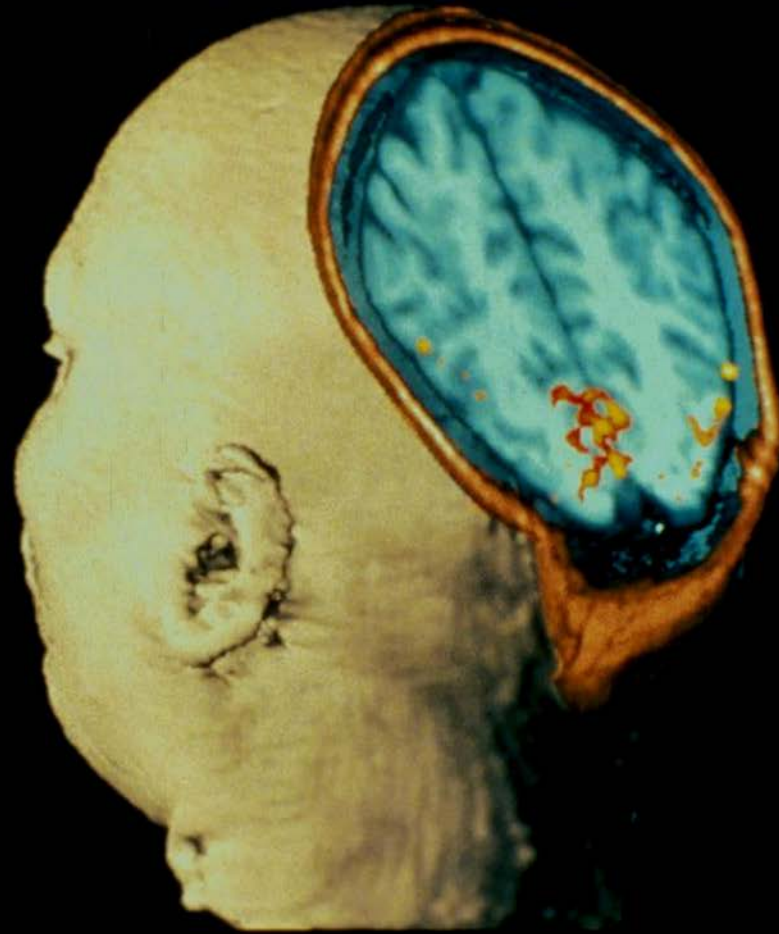

Susceptibility Contrast

Susceptibility-Induced Field Distortion in the Vicinity of a Microvessel \perp to B_0 .

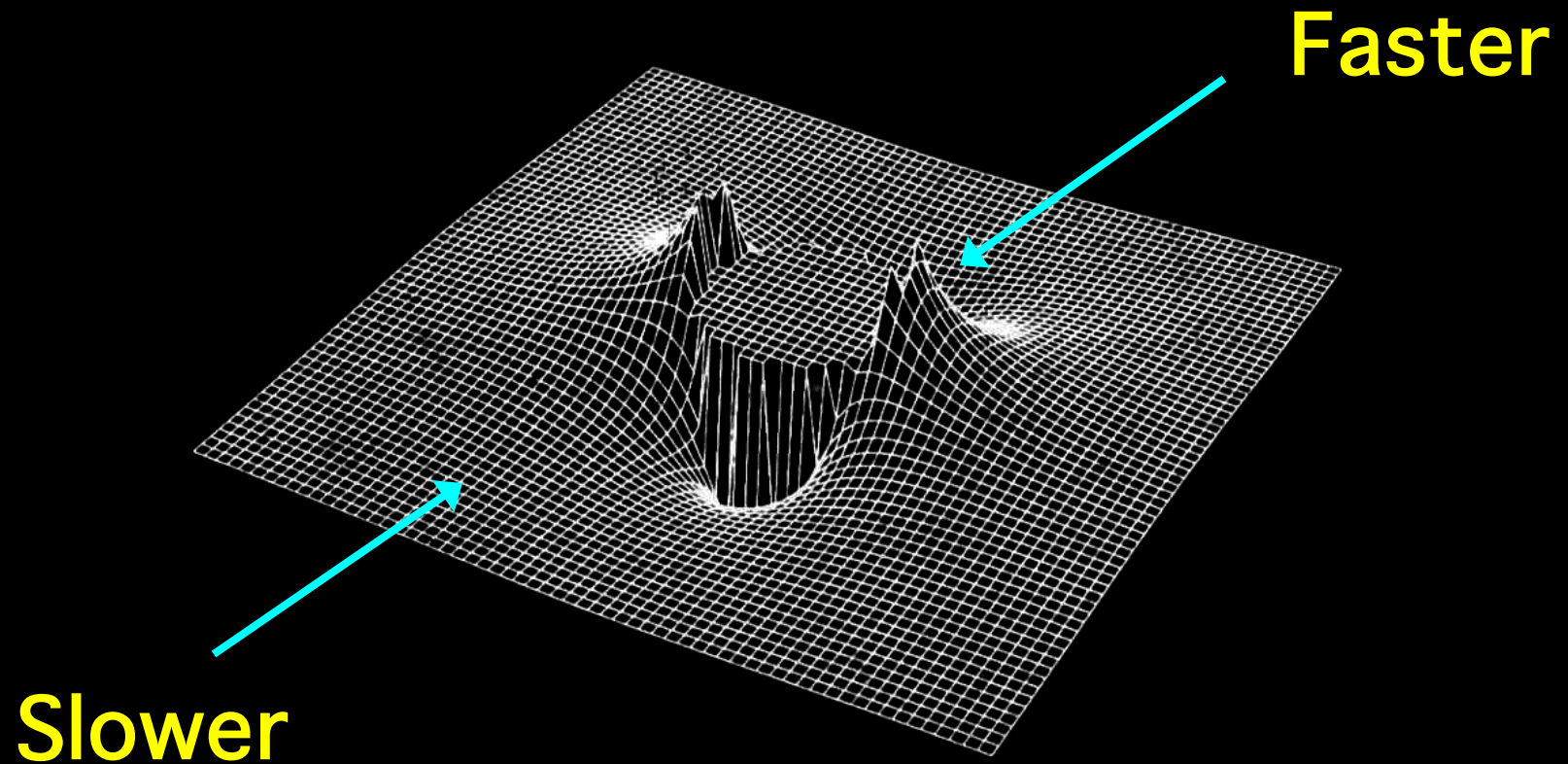

BOLD Contrast in the Detection of Neuronal Activity

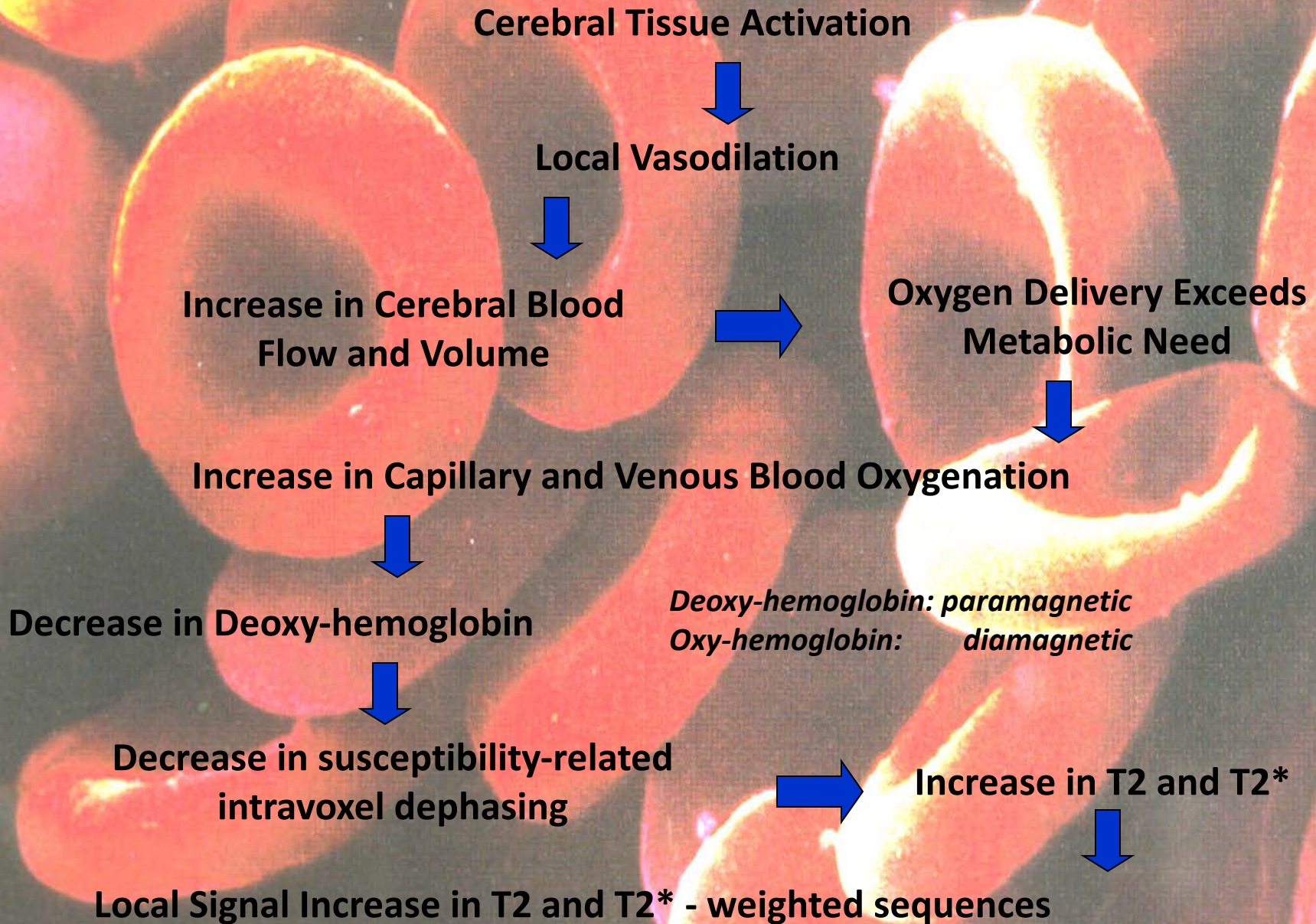

The BOLD Signal

Blood Oxygenation Level Dependent (BOLD) signal changes

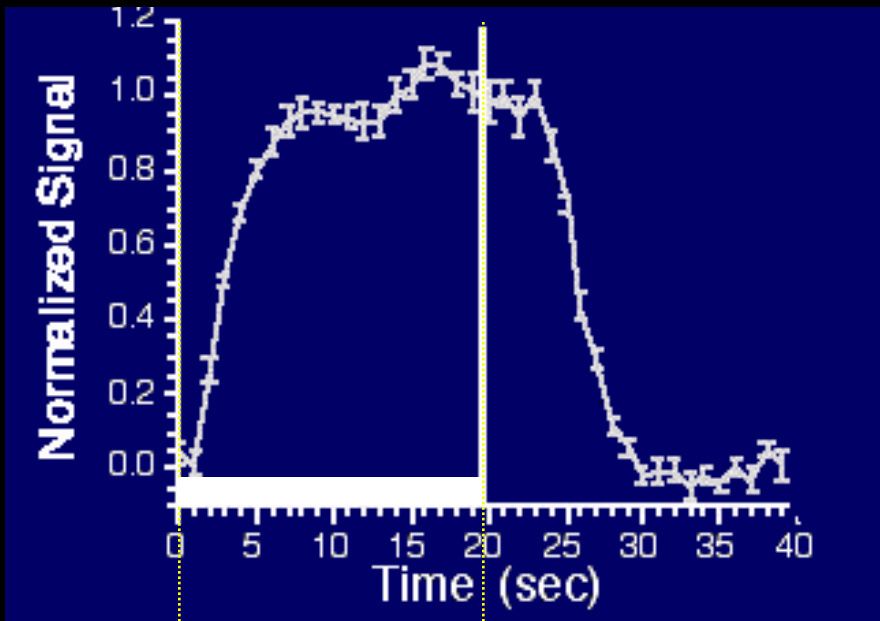

task

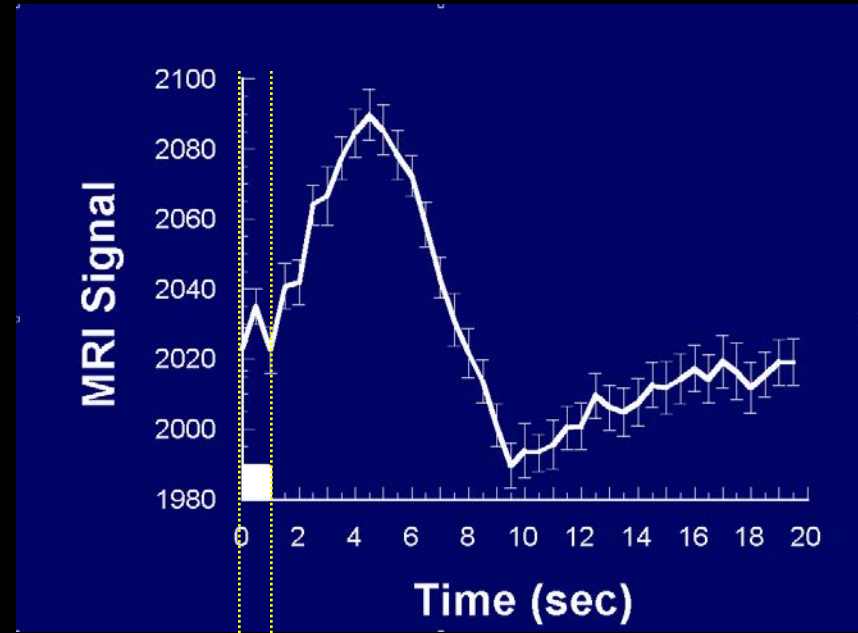

task

Alternating Left and Right Finger Tapping



~ 1992

K. K. Kwong, et al, (1992) “Dynamic magnetic resonance imaging of human brain activity during primary sensory stimulation.” Proc. Natl. Acad. Sci. USA. 89, 5675-5679.

S. Ogawa, et al., (1992) “Intrinsic signal changes accompanying sensory stimulation: functional brain mapping with magnetic resonance imaging. Proc. Natl. Acad. Sci. USA.” 89, 5951-5955.

P. A. Bandettini, et al., (1992) “Time course EPI of human brain function during task activation.” Magn. Reson. Med 25, 390-397.

Blamire, A. M., et al. (1992). “Dynamic mapping of the human visual cortex by high-speed magnetic resonance imaging.” Proc. Natl. Acad. Sci. USA 89: 11069-11073.

Creating a Functional Image

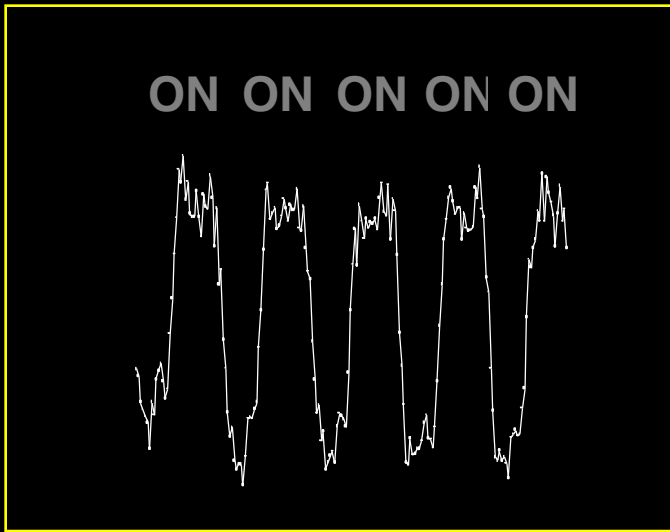

Signal Time Course

X

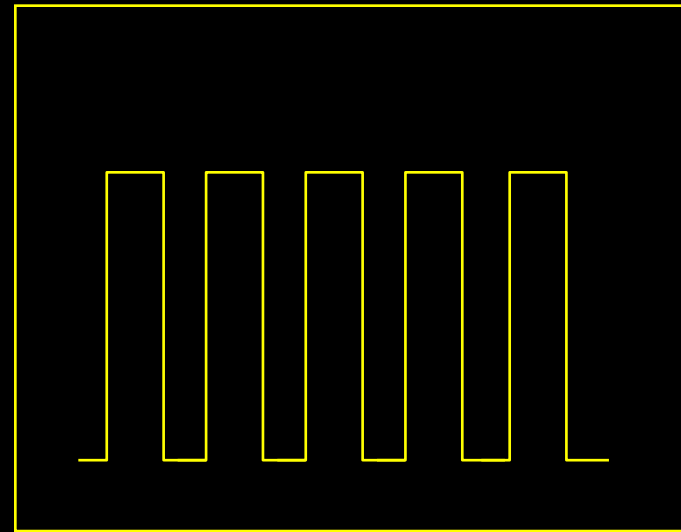

Reference Function

=



P. A. Bandettini, A. Jesmanowicz, E. C. Wong, J. S. Hyde, Processing strategies for time-course data sets in functional MRI of the human brain. *Magn. Reson. Med.* **30**, 161-173 (1993).



Cross Correlation Image

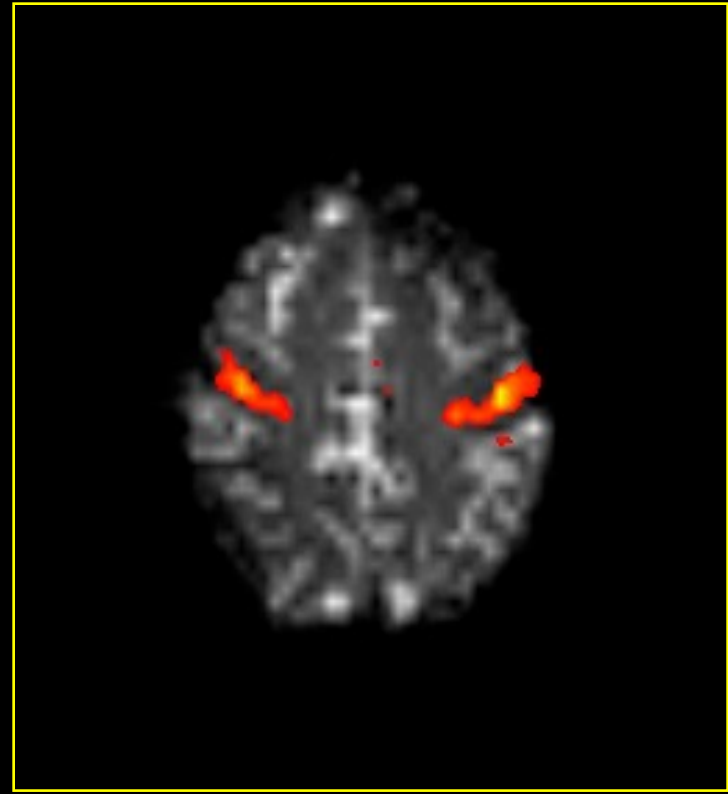

Cross Correlation Image
Anatomical Image

P. A. Bandettini, A. Jesmanowicz, E. C. Wong, J. S. Hyde, Processing strategies for time-course data sets in functional MRI of the human brain. *Magn. Reson. Med.* 30, 161-173 (1993).

Correlation analysis, Fourier analysis, t-test, f-test...
SPM, AFNI, brain voyager, FIASCO, FSL, free surfer...



*Quality of results and importance of the findings depends on
type of question asked, experimental method, and analysis method...*

Blood Perfusion

EPISTAR

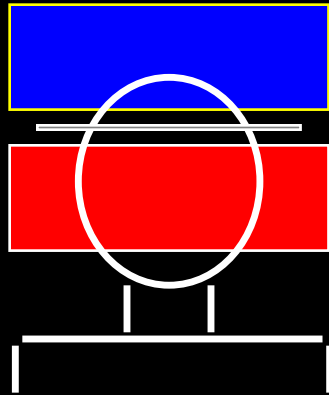

FAIR

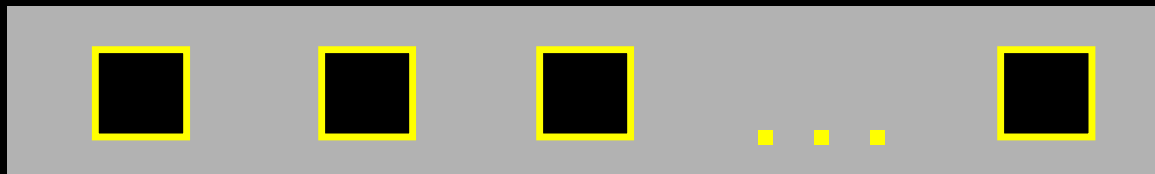
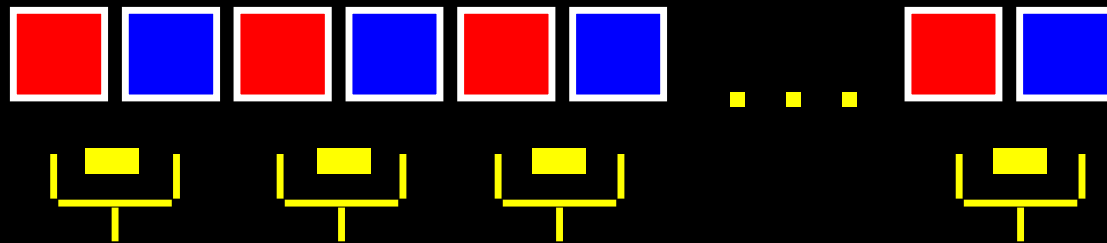
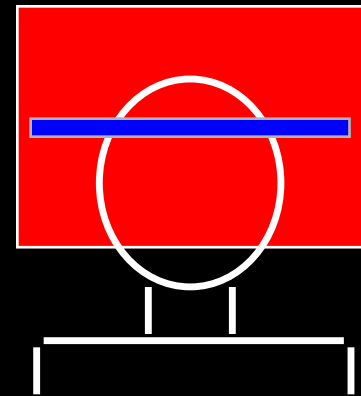

**Perfusion
Time Series**

TI (ms)

FAIR

EPISTAR

200

400

600

800

1000

1200

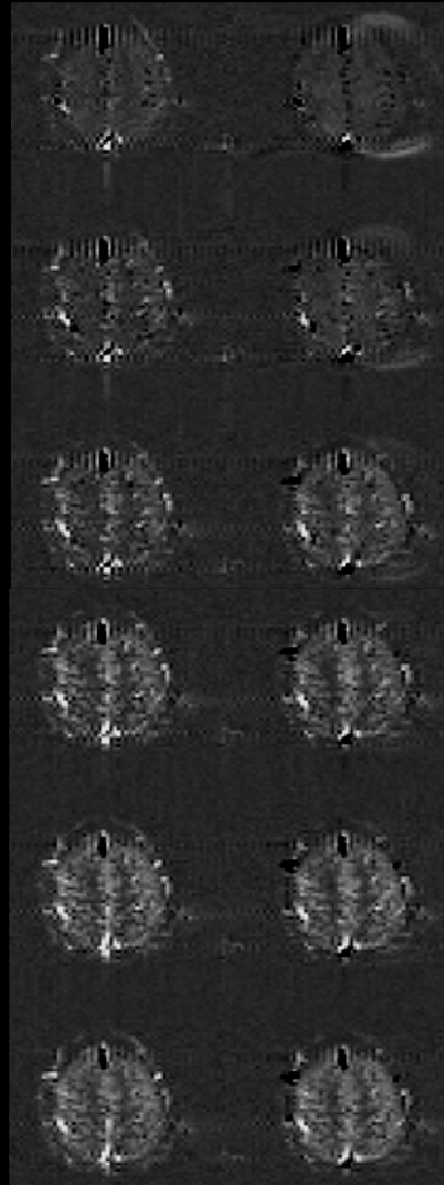

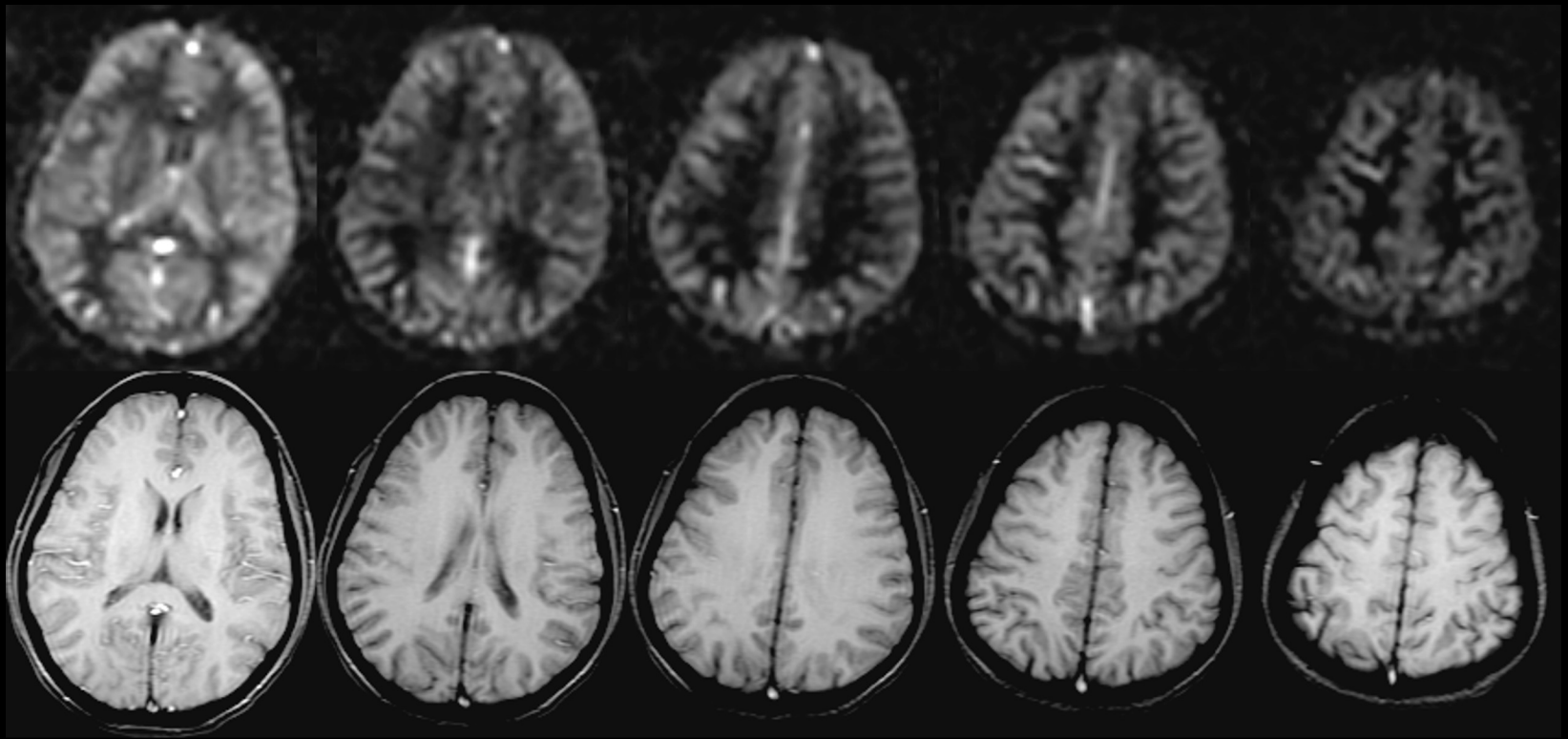

Williams, D. S., Detre, J. A., Leigh, J. S. & Koretsky, A. S. (1992) "Magnetic resonance imaging of perfusion using spin-inversion of arterial water." *Proc. Natl. Acad. Sci. USA* 89, 212-216.

Edelman, R., Siewert, B. & Darby, D. (1994) "Qualitative mapping of cerebral blood flow and functional localization with echo planar MR imaging and signal targeting with alternating radiofrequency (EPISTAR)." *Radiology* 192, 1-8.

Kim, S.-G. (1995) "Quantification of relative cerebral blood flow change by flow-sensitive alternating inversion recovery (FAIR) technique: application to functional mapping." *Magn. Reson. Med.* 34, 293-301.

Kwong, K. K. et al. (1995) "MR perfusion studies with T1-weighted echo planar imaging." *Magn. Reson. Med.* 34, 878-887.

Comparison with Positron Emission Tomography

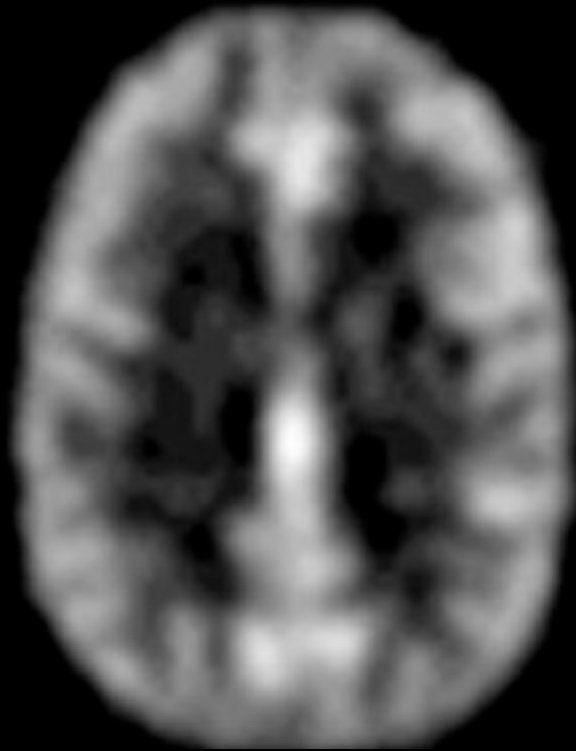

PET: H_2^{15}O

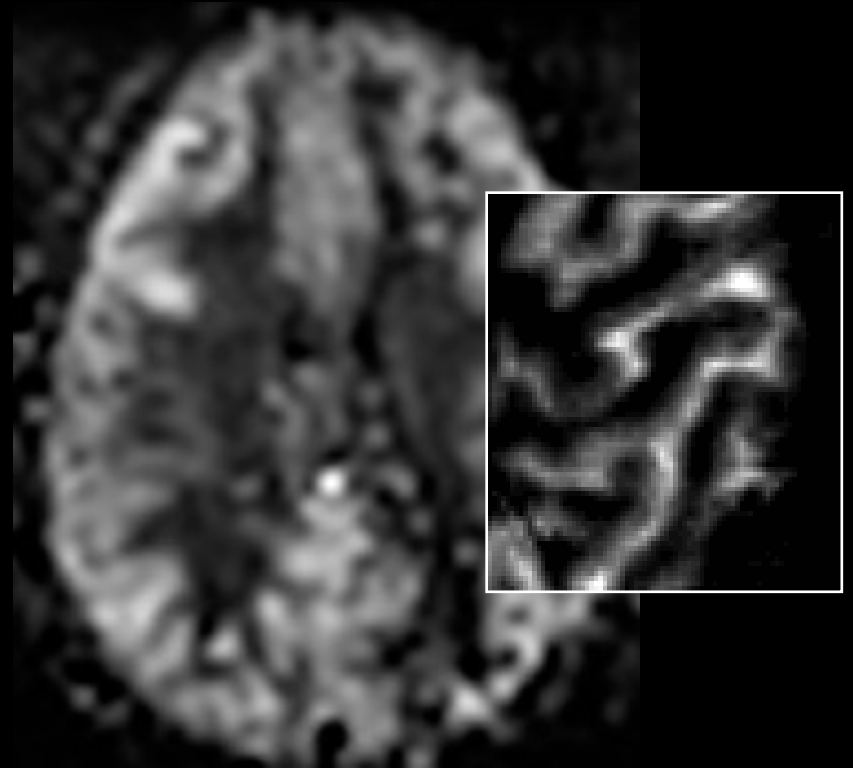

MRI: ASL

Perfusion

Rest

Activation

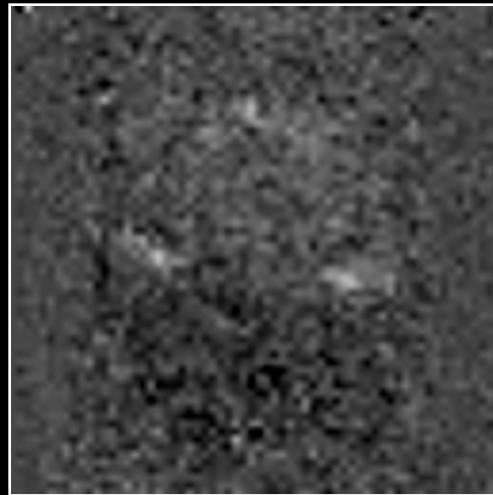
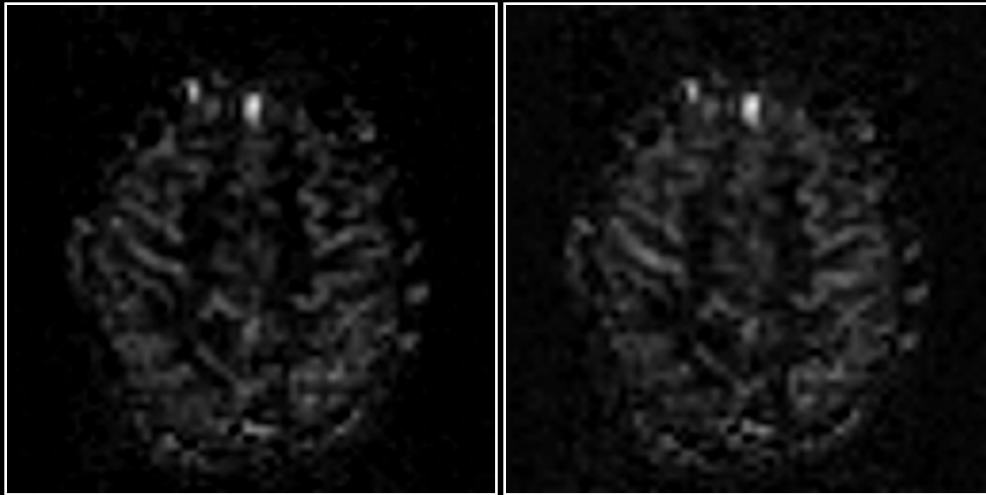

+

-

Volume

- unique information
- baseline information
- multislice trivial

- invasive
- low C / N for func.

BOLD

- highest C / N
- easy to implement
- multislice trivial
- non invasive
- highest temp. res.

- complicated signal
- no baseline info.

Perfusion

- unique information
- control over ves. size
- baseline information
- non invasive

- multislice non trivial
- lower temp. res.
- low C / N

Refinements

BOLD Contrast Interpretation

Dynamics

Paradigm Design and Processing

Refinements

BOLD Contrast Interpretation

Dynamics

Paradigm Design and Processing

The Neuroscientists' Challenge:

...to make progressively more precise inferences using fMRI without making too many assumptions about non-neuronal physiologic factors.

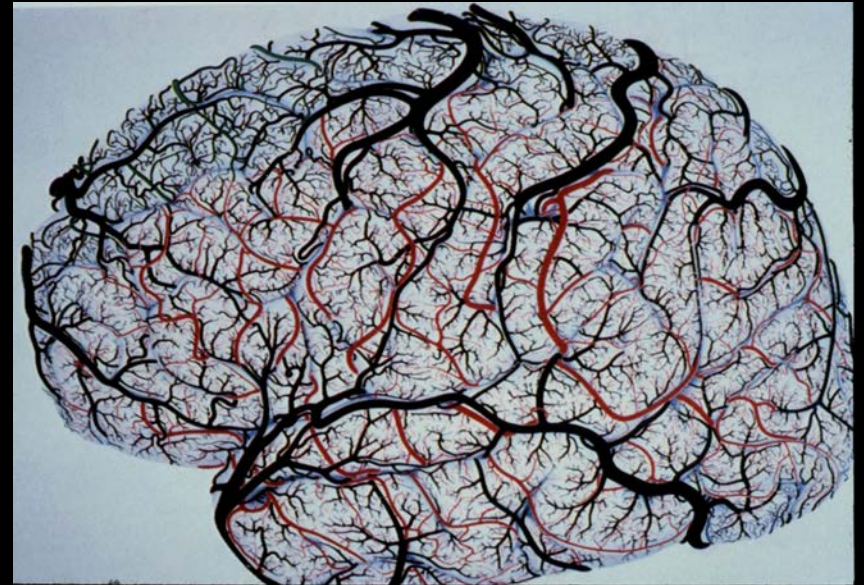
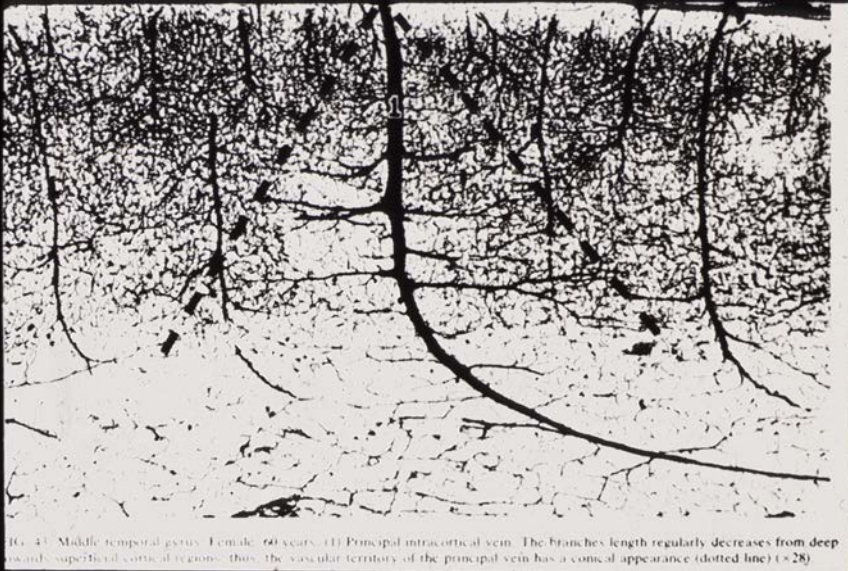

The use of fMRI for the Investigation of Brain Function and Physiology

- Where?

- When?

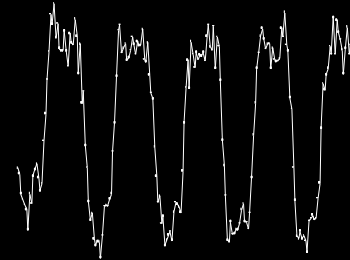
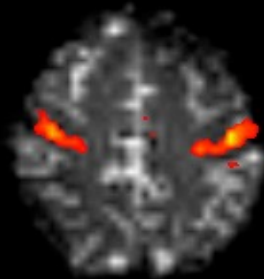

- How much?

- How to get the brain to do what we want it to do in the context of an fMRI experiment?

(limitations: limited time and signal to noise, motion, acoustic noise)

- How much more information can we obtain?

Neuronal
Activation



Measured
Signal

Hemodynamics

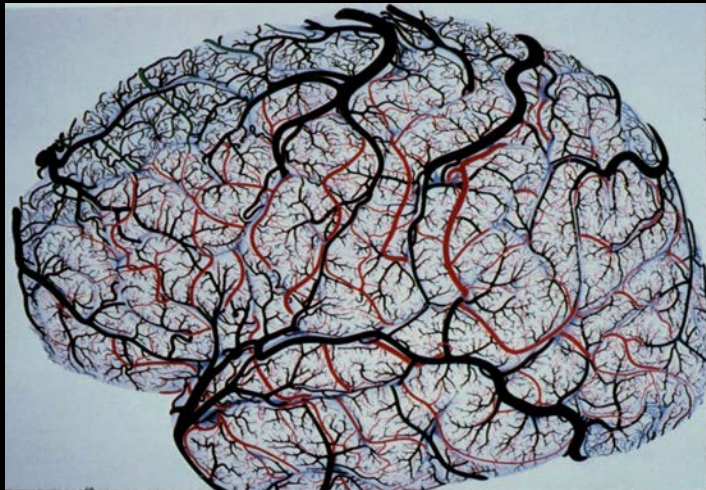

Noise

?

?

?

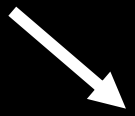

Spin-echo vs. Gradient-echo

Gradient-Echo EPI

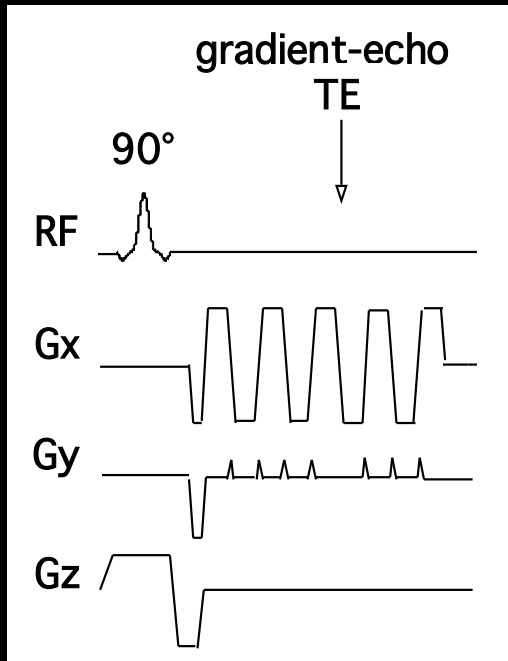

Spin-Echo EPI

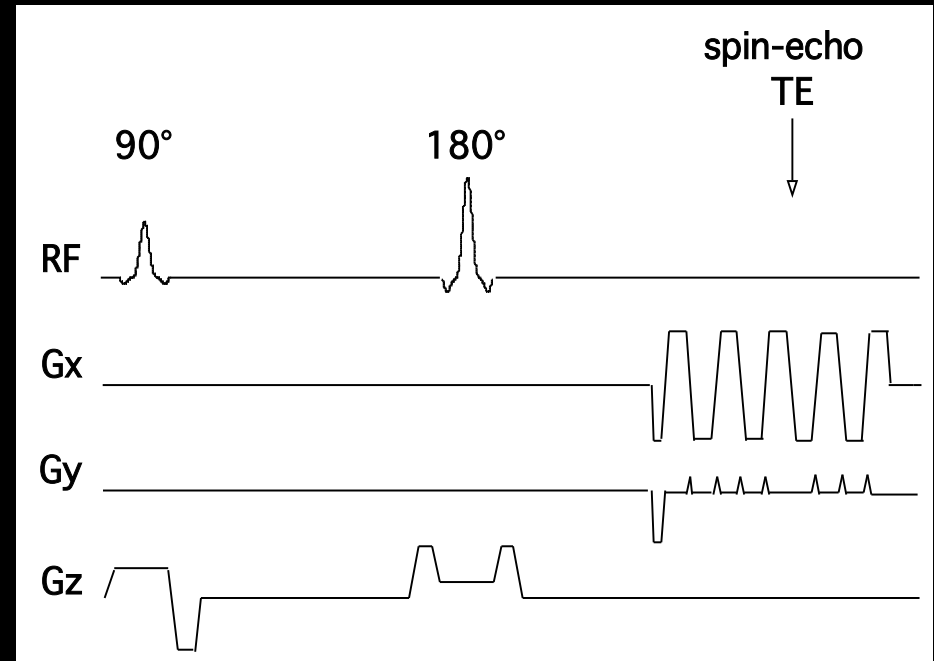

Contrast

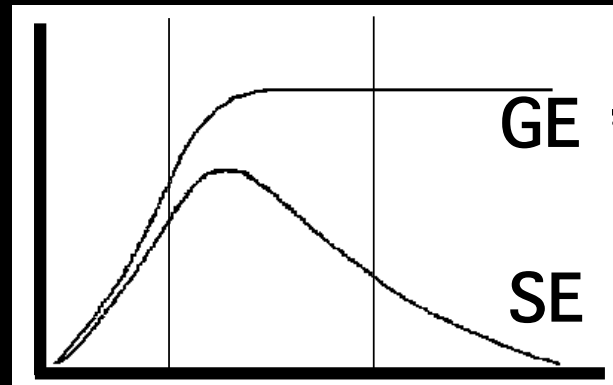

2.5 to 3 μm 3 to 15 μm 15 to ∞ μm

compartment size

$$\Delta R2^* / \Delta R2$$

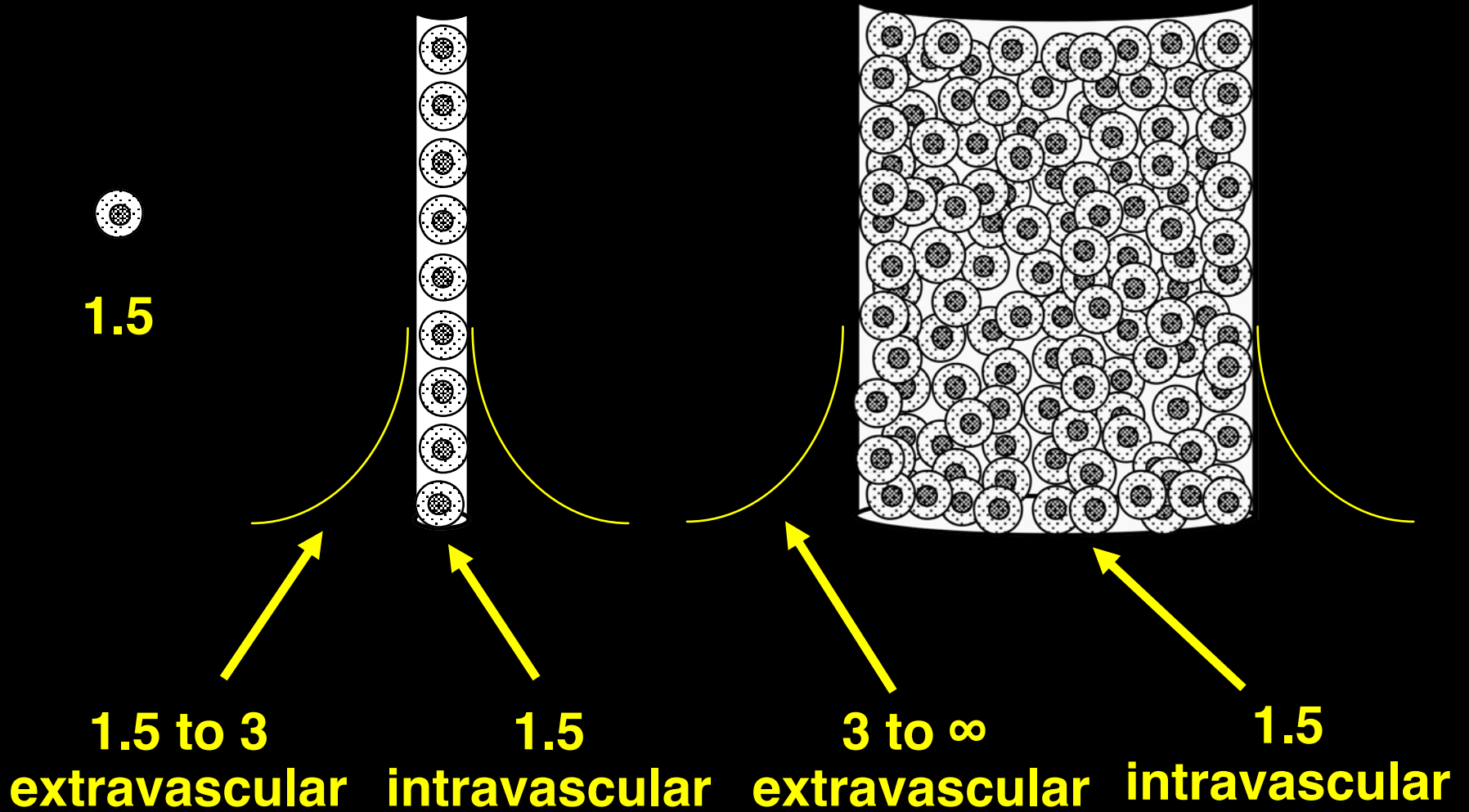

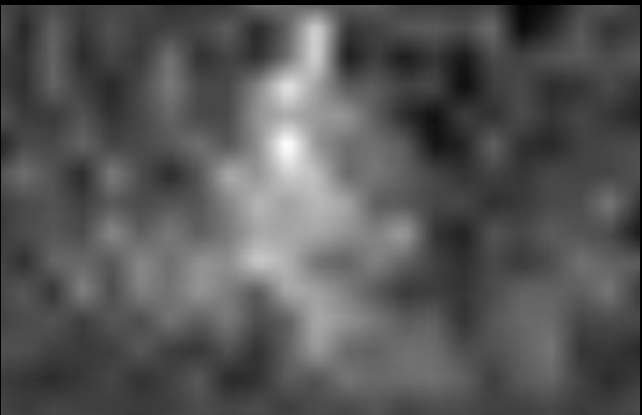
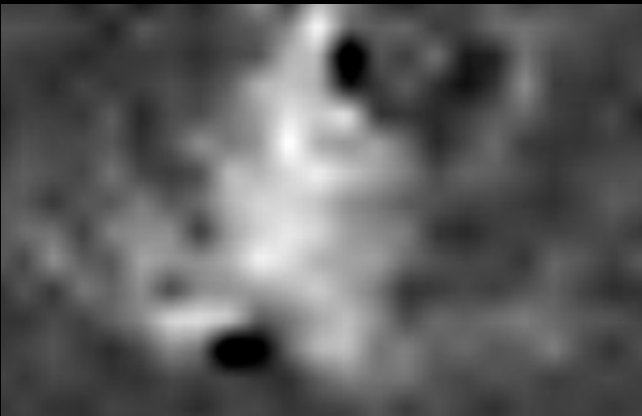
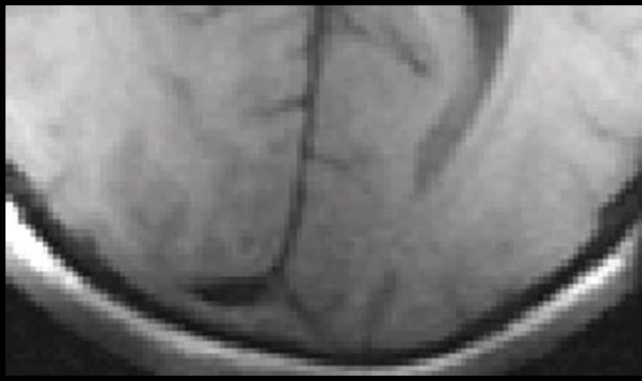

Contrast

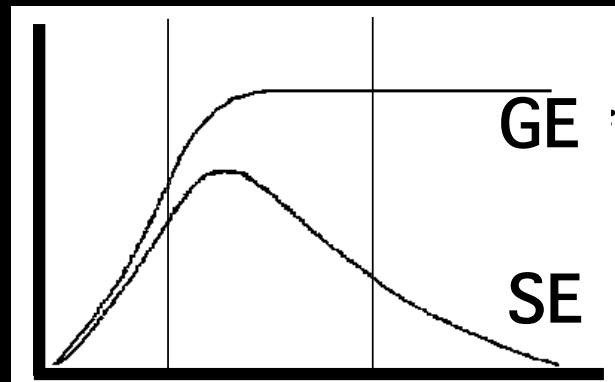

2.5 to 3 μm 3 to 15 μm 15 to ∞ μm

compartment size

Gradient - Echo

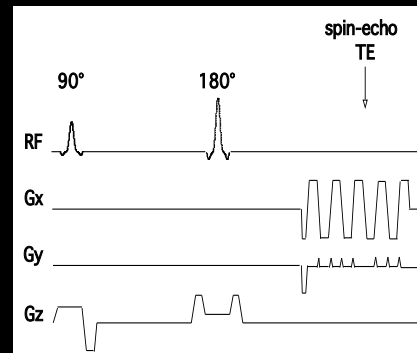
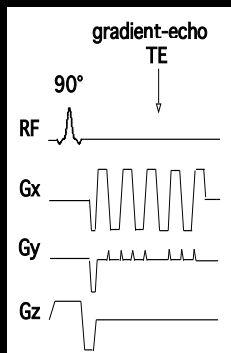

Spin - Echo

GE
TE = 30 ms

SE
TE = 110 ms

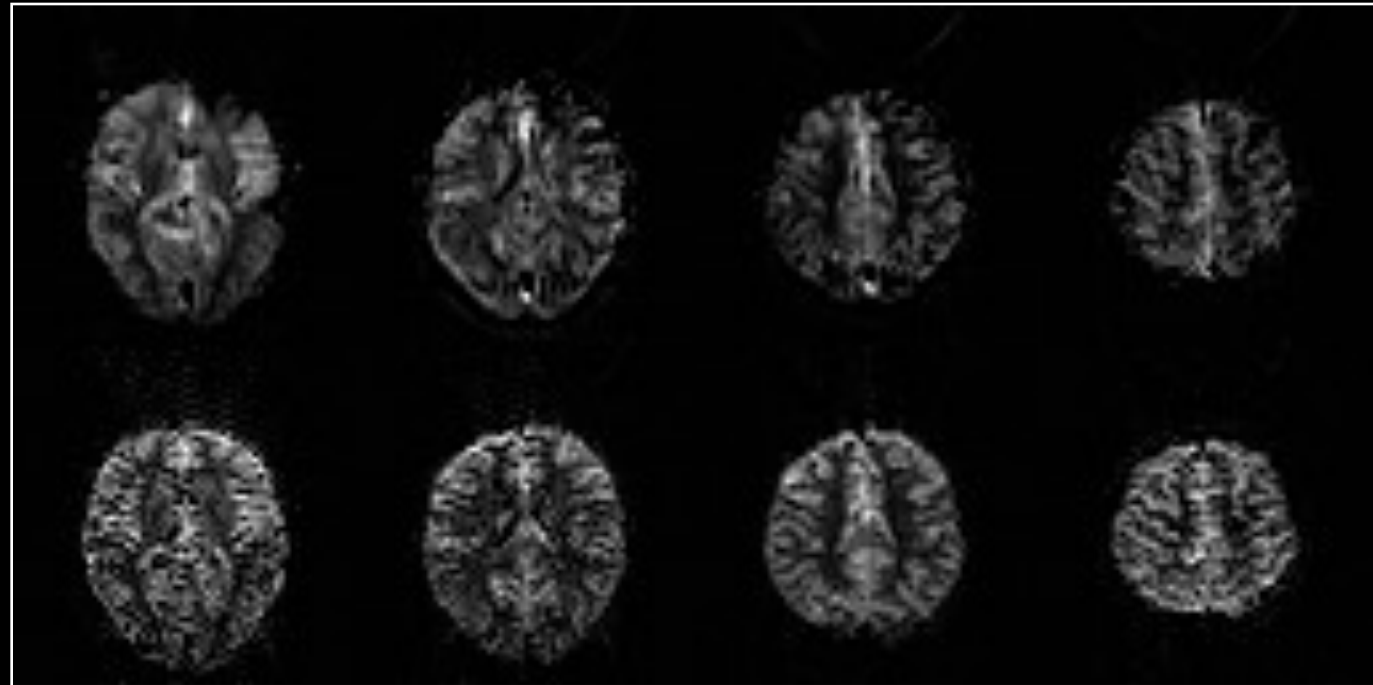

3T

Spin-Echo
TE = 105 ms
TR = ∞



Gradient-Echo
TE = 50 ms



Gradient-Echo functional
TE = 50 ms

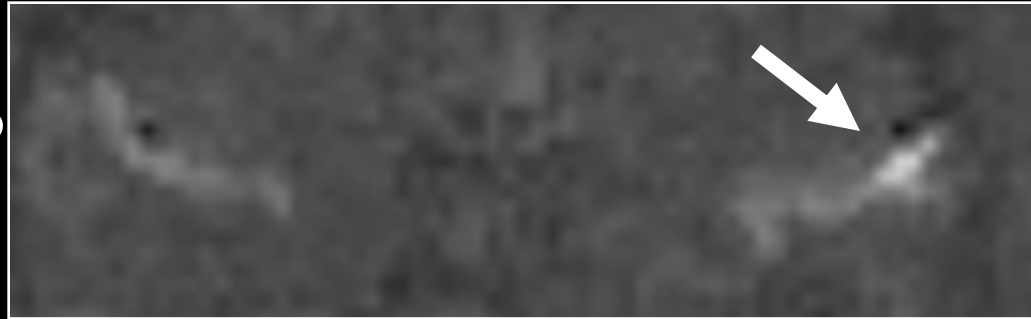

Spin-Echo functional
TE = 105 ms



Effect of diffusion weighting

$\Delta R2^* / \Delta R2$

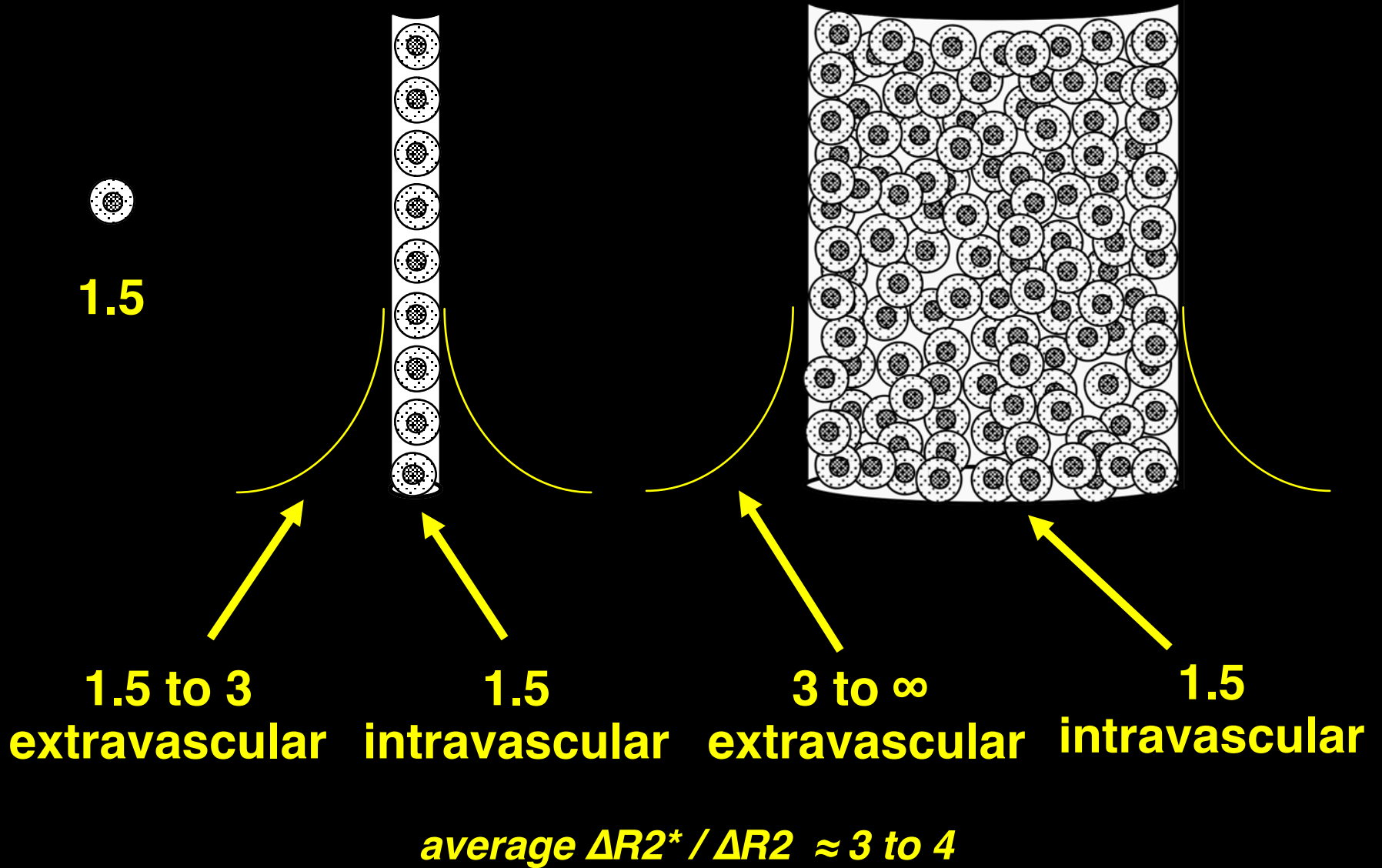

no diffusion weighting

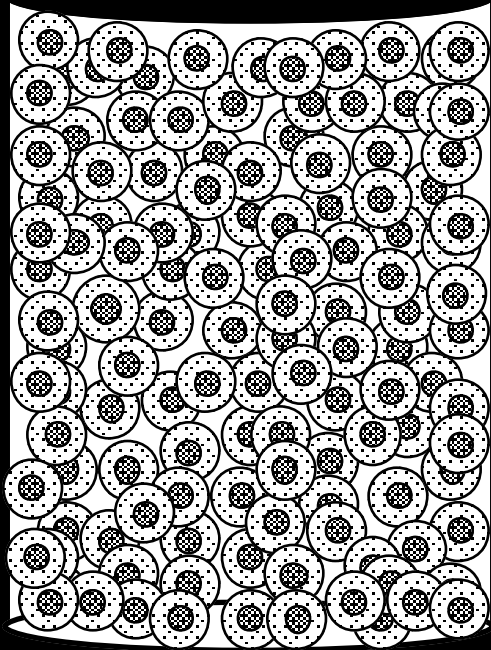

diffusion weighting

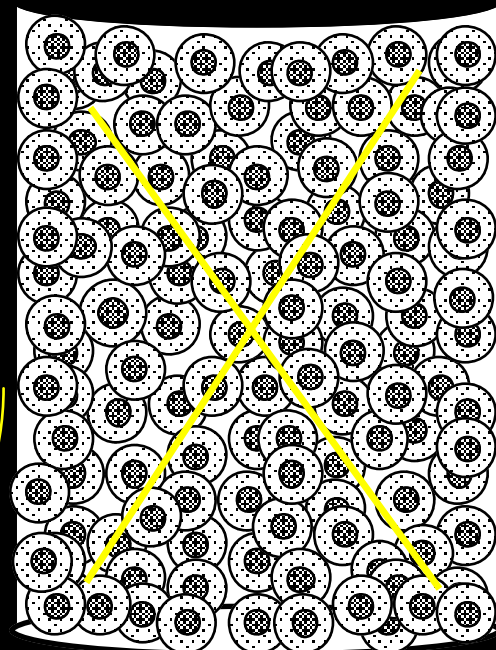

Summary of Diffusion-Weighted fMRI Data

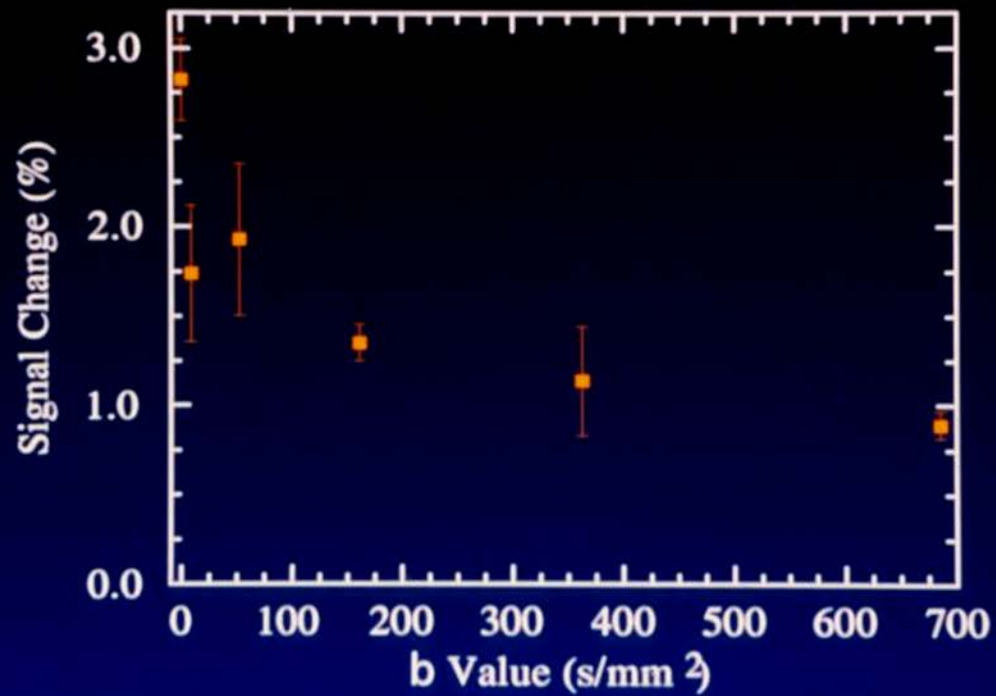

$b = 0$

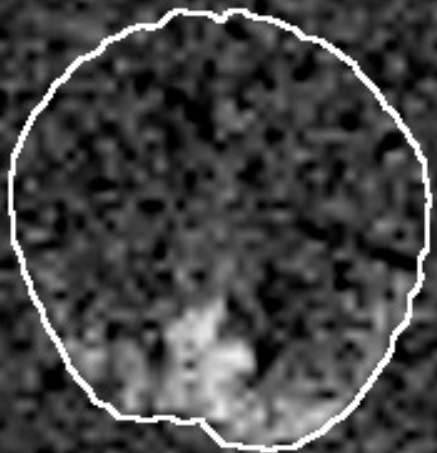

$b = 10$



$b = 50$

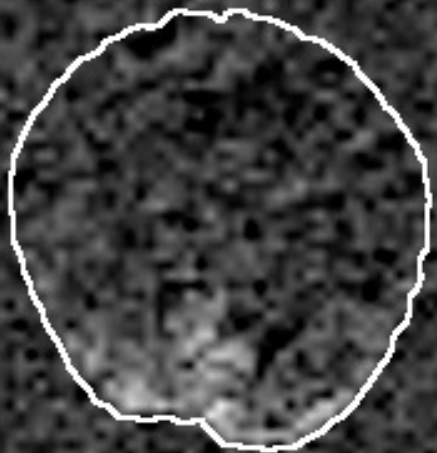

$b = 160$



Echo time dependence

Gradient-Echo EPI

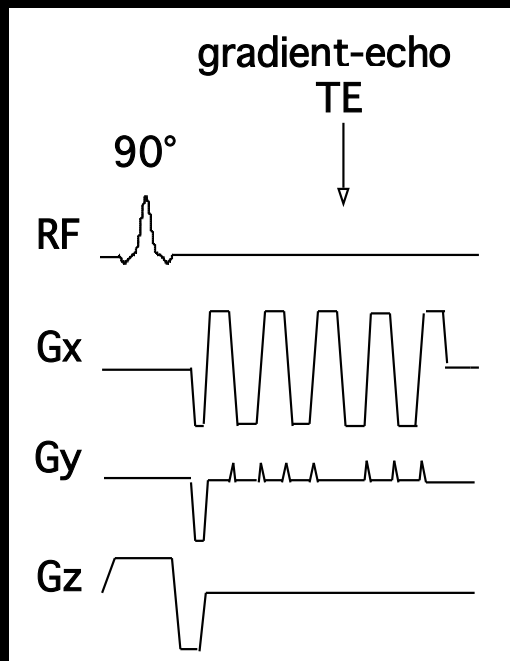

Spin-Echo EPI

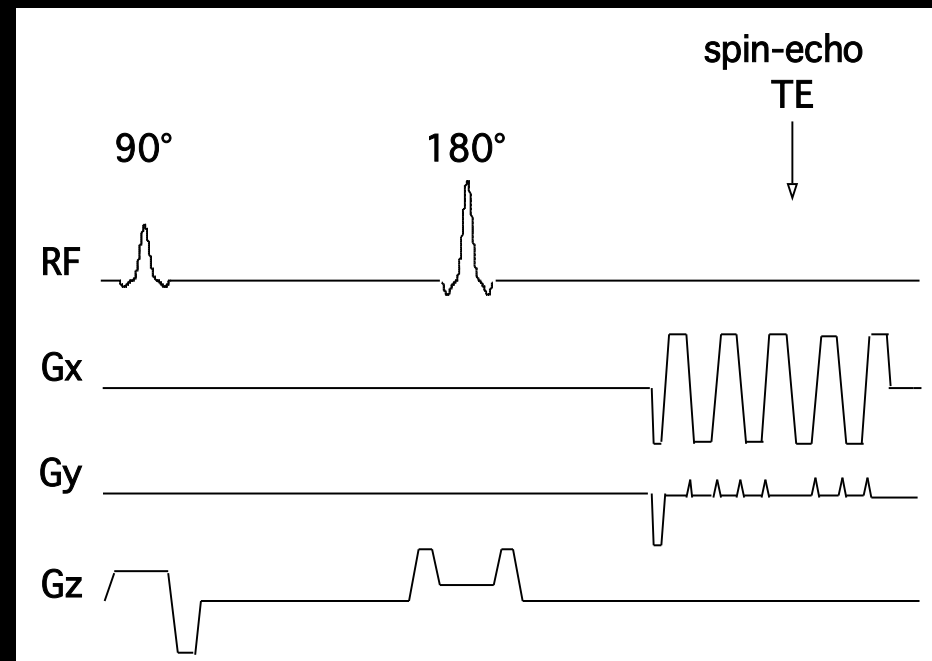

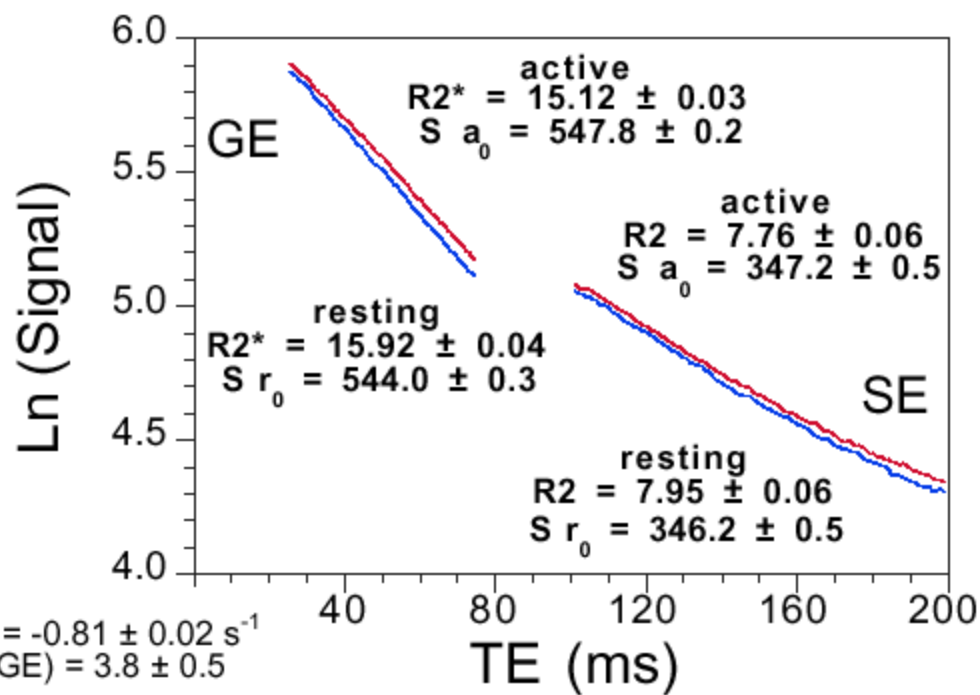

$$\Delta R2^* = -0.81 \pm 0.02 \text{ s}^{-1}$$

$$\Delta S_0 \text{ (GE)} = 3.8 \pm 0.5$$

$$\Delta R2 = -0.19 \pm 0.02 \text{ s}^{-1}$$

$$\Delta S_0 \text{ (SE)} = 1.0 \pm 1.0$$

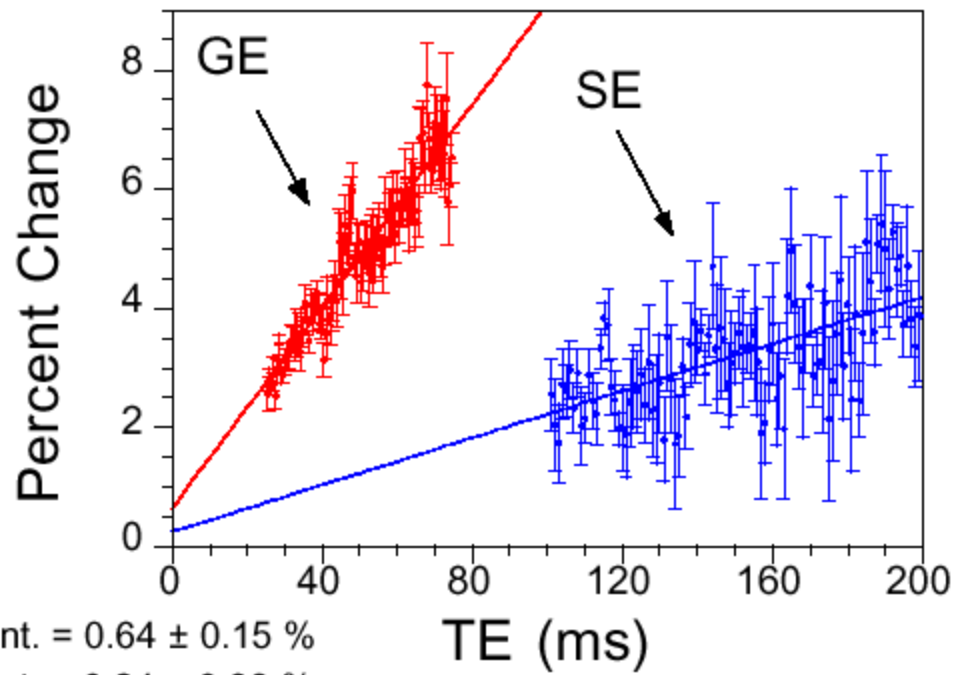

GE int. = 0.64 ± 0.15 %

SE int. = 0.24 ± 0.38 %

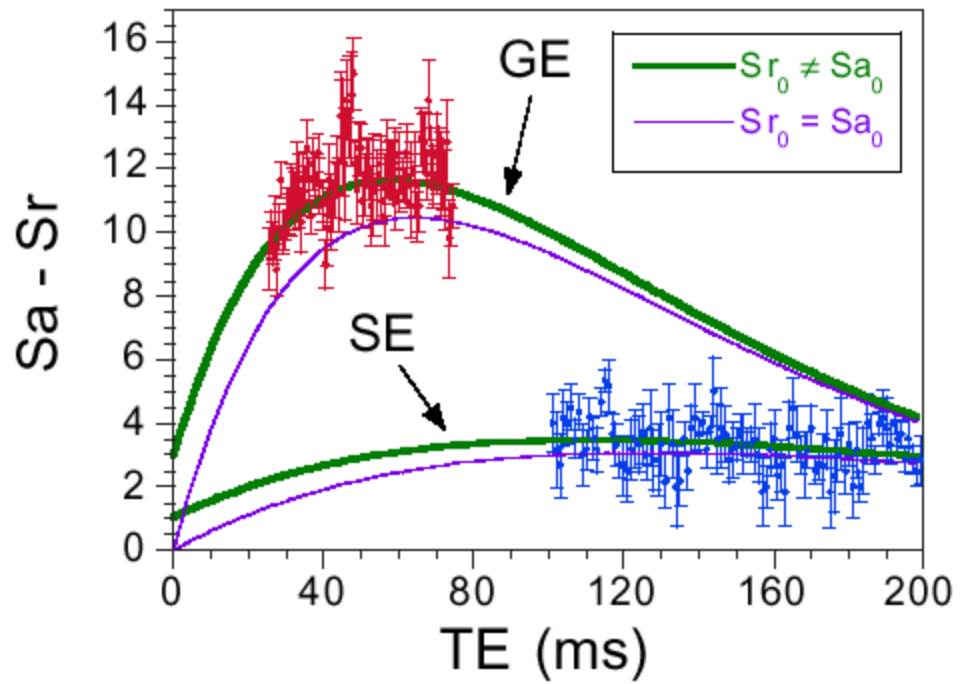

Perfusion localization vs. BOLD localization

T1 - weighted

Flow weighted

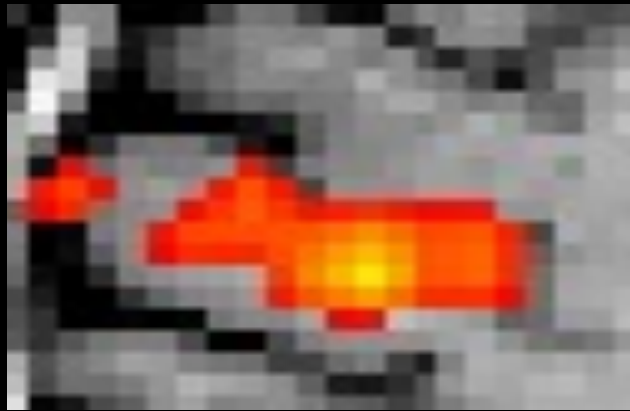

T2* weighted

BOLD weighted



T1 and T2* weighted

Flow and BOLD weighted



P. A. Bandettini, E. C. Wong, Echo - planar magnetic resonance imaging of human brain activation, in "Echo Planar Imaging: Theory, Technique, and Application" (F. Schmitt, M. Stehling, R. Turner, Eds.), p.493-530, Springer - Verlag, Berlin, 1997

Perfusion

BOLD

Rest

Activation

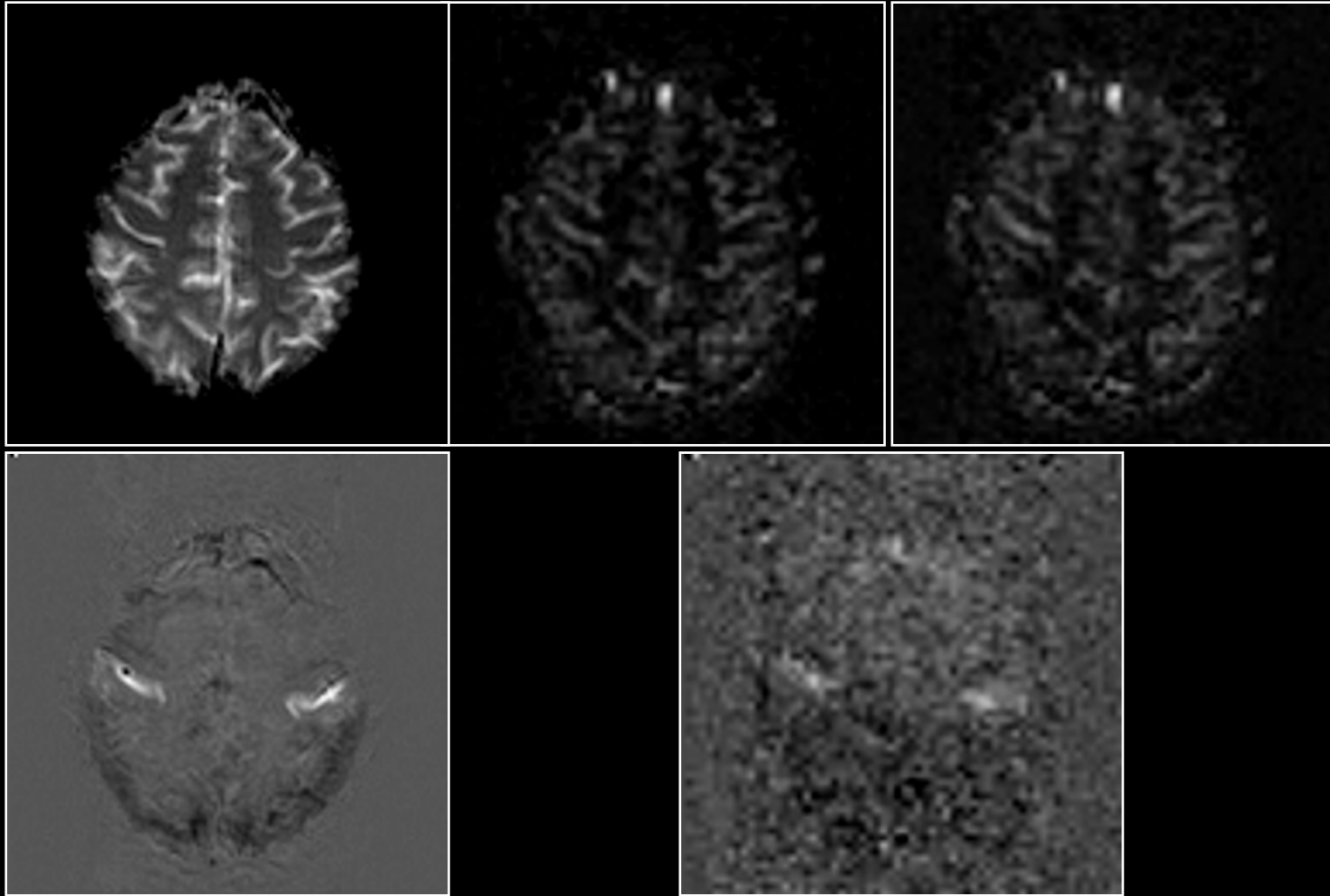

P. A. Bandettini, E. C. Wong, Magnetic resonance imaging of human brain function: principles, practicalities, and possibilities, *in* "Neurosurgery Clinics of North America: Functional Imaging" (M. Haglund, Ed.), p.345-371, W. B. Saunders Co., 1997.

Anatomy



BOLD

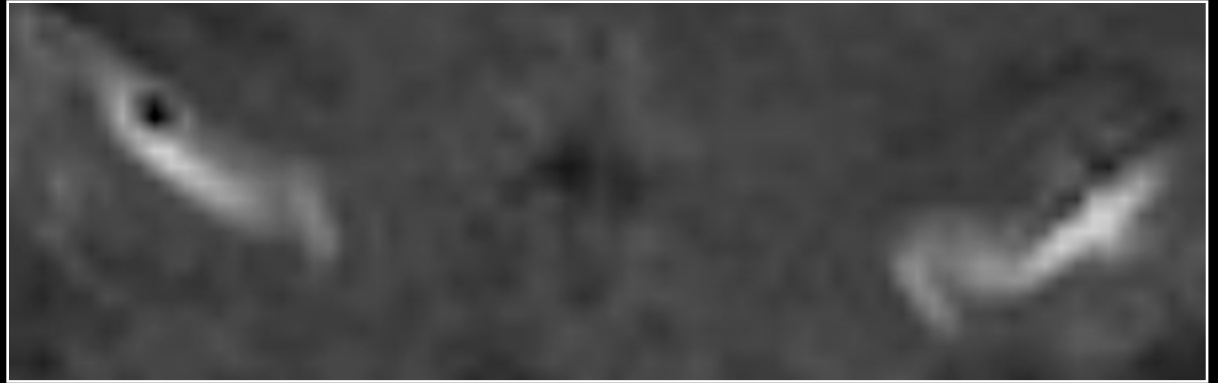

Perfusion



P. A. Bandettini, E. C. Wong, Magnetic resonance imaging of human brain function: principles, practicalities, and possibilities, *in* "Neurosurgery Clinics of North America: Functional Imaging" (M. Haglund, Ed.), p.345-371, W. B. Saunders Co., 1997.

Simultaneous Flow and BOLD

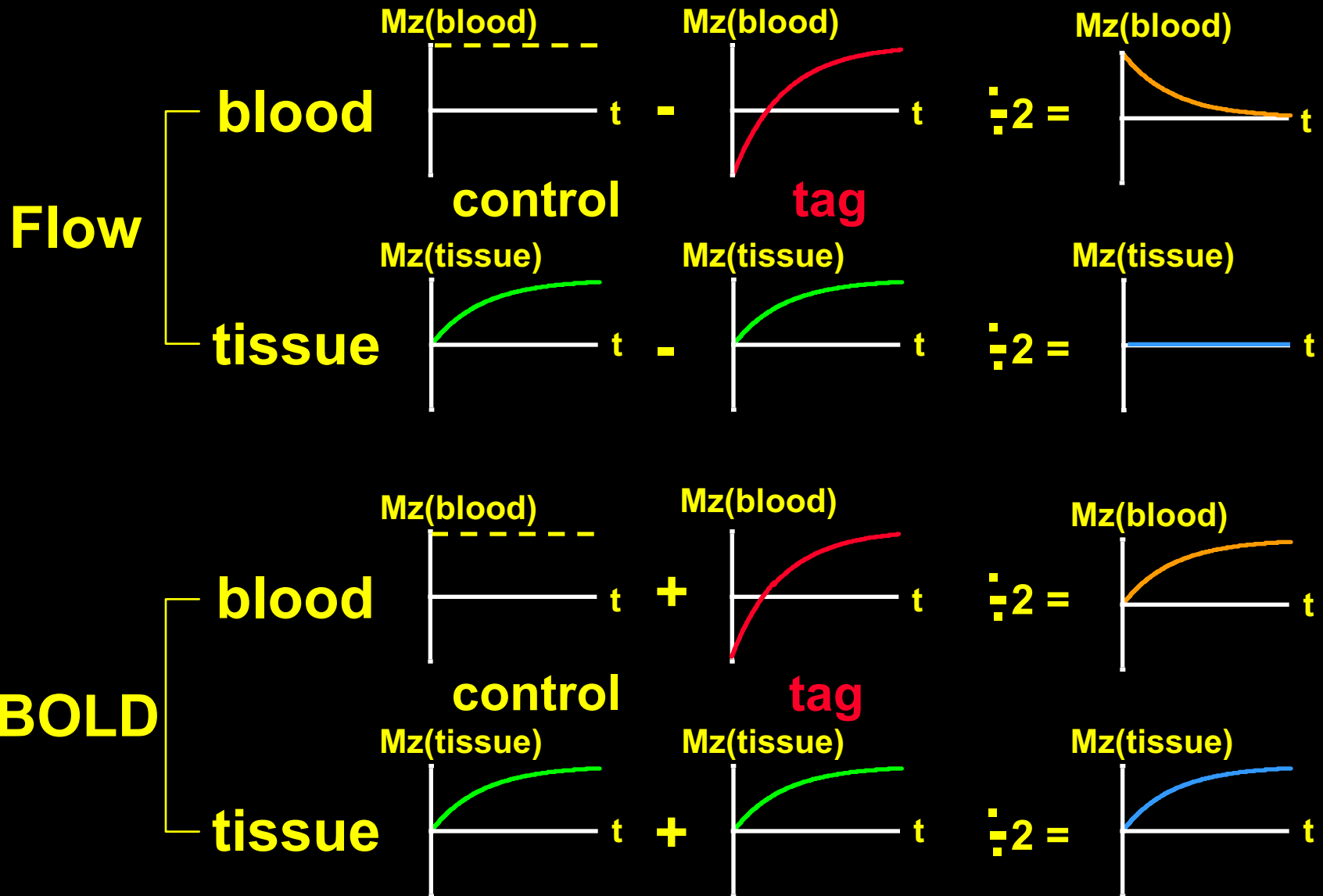

Simultaneous BOLD and Perfusion



BOLD



Perfusion

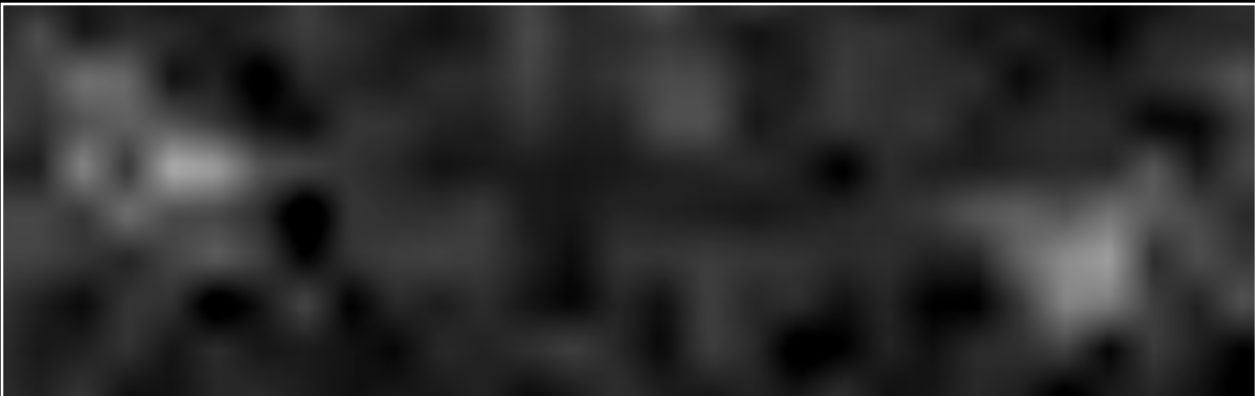

Simultaneous perfusion and BOLD imaging (10 min, $1.5 \times 1.5 \times 4 \text{mm}^3$)

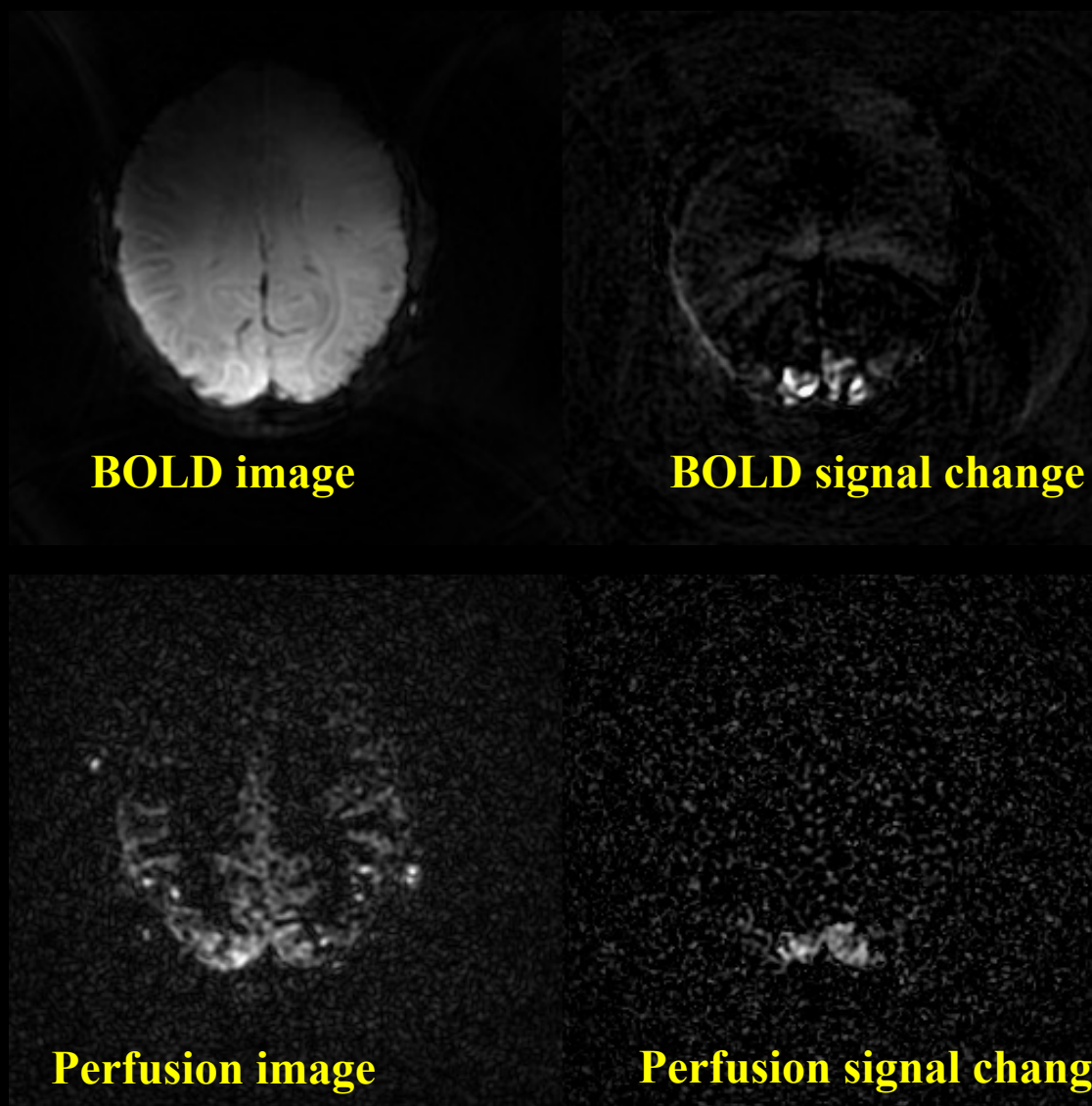

What Changes with Field Strength?

Tissue Relaxation Characteristics

Functional Contrast

Signal to Noise Ratio

B₀ Inhomogeneity Effects

RF Power Deposition

Mechanical Force on Gradient Coil

T1 Values Across Field Strengths

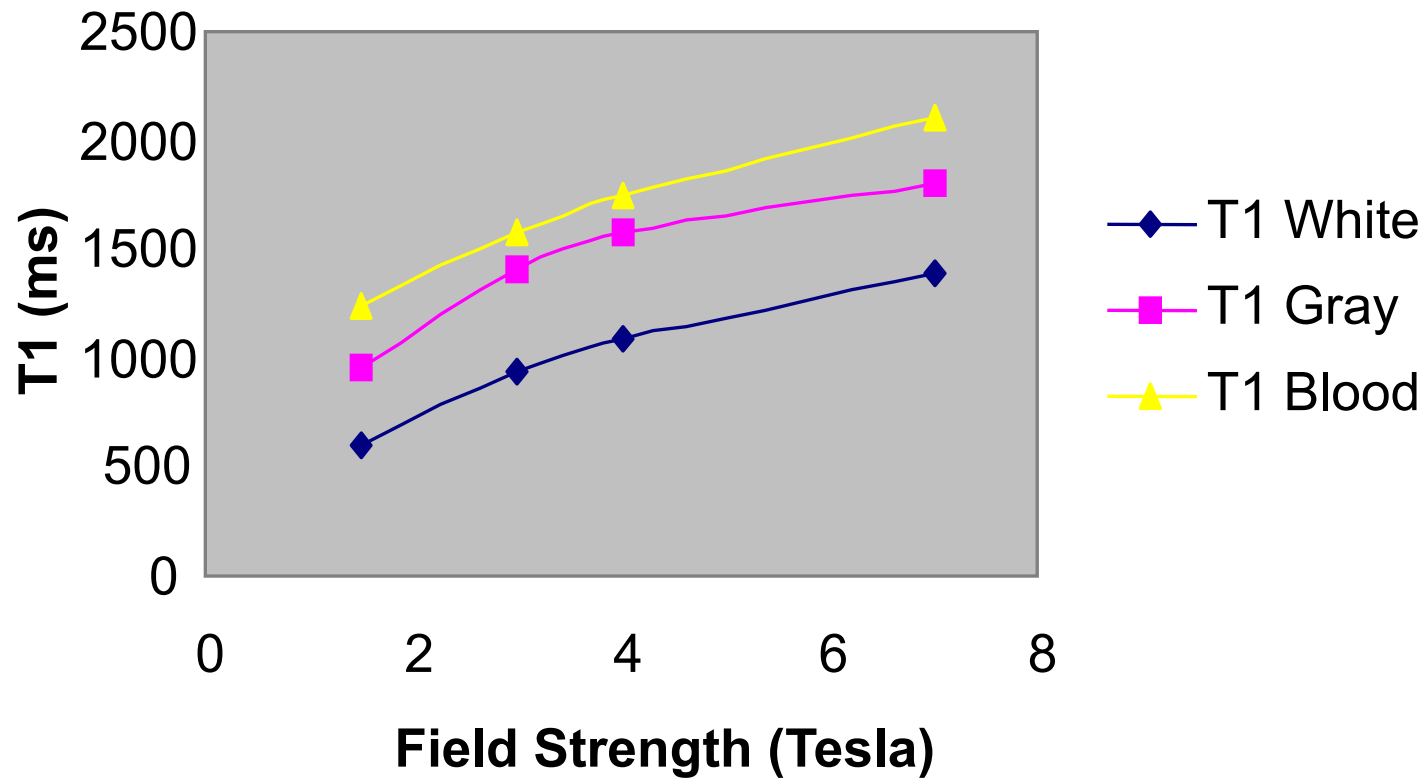

T2 Values Across Field Strengths

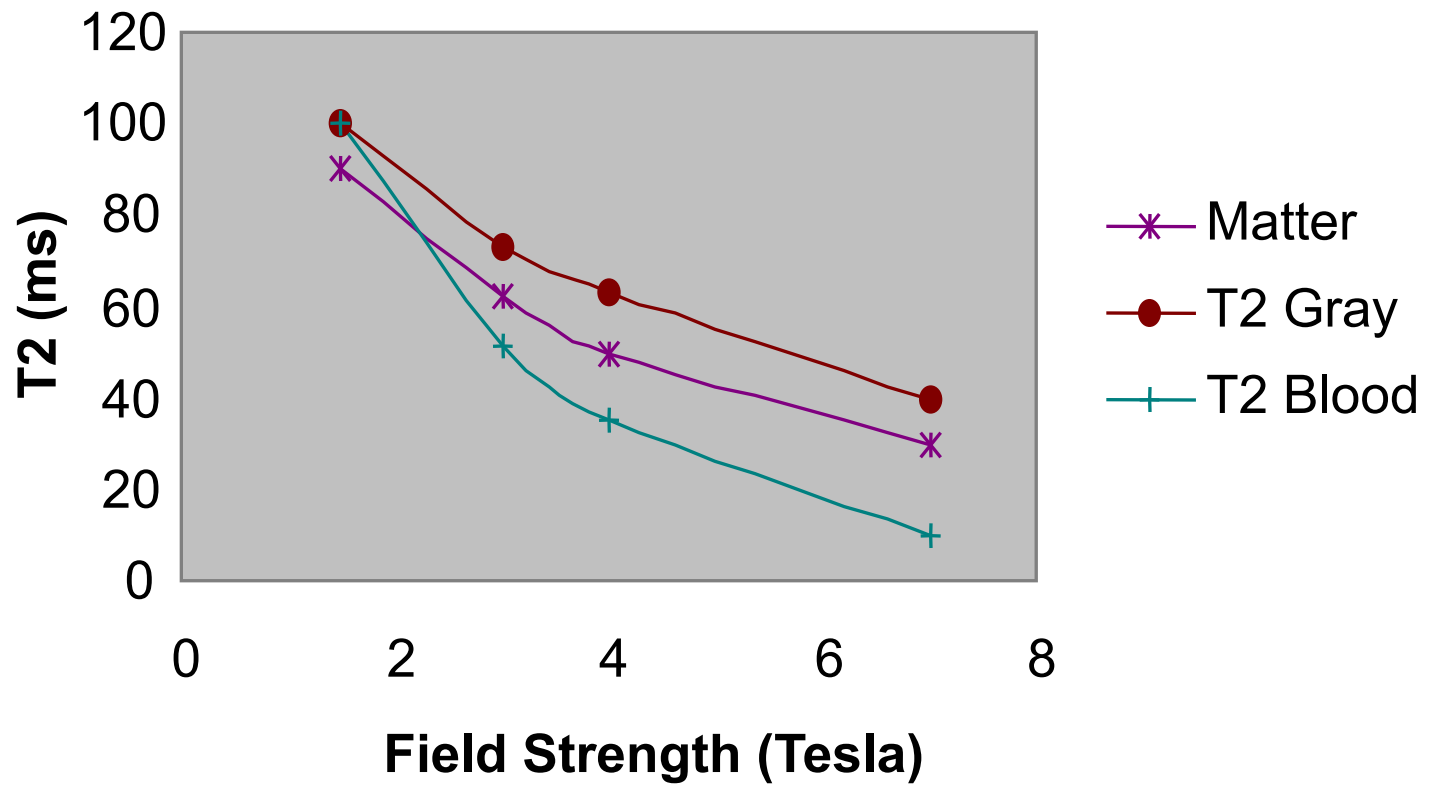

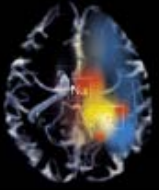

UIC
Thulborn

Whole Brain Anatomy

T1-SE

T2-FSE

FLAIR

1.5T

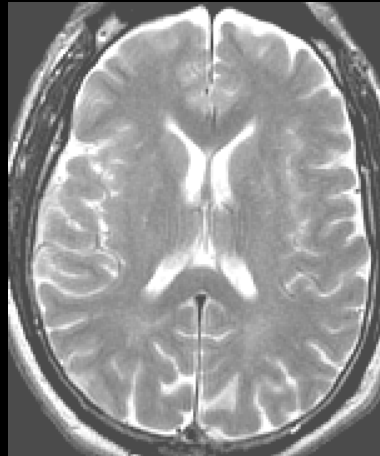

3.0T

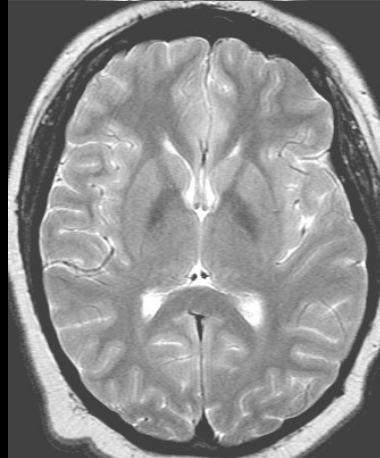
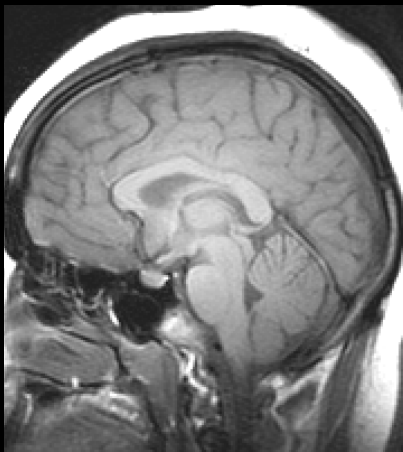

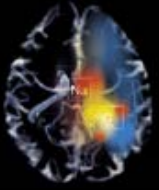

UIC
Thulborn

3.0T: 3D TOF MRA

Longer T1 at 3.0T enhances flow effects and improves background suppression as well as allows higher spatial resolution



15 y.o. female patient



57 y.o. male patient

T2* Values Across Field Strengths

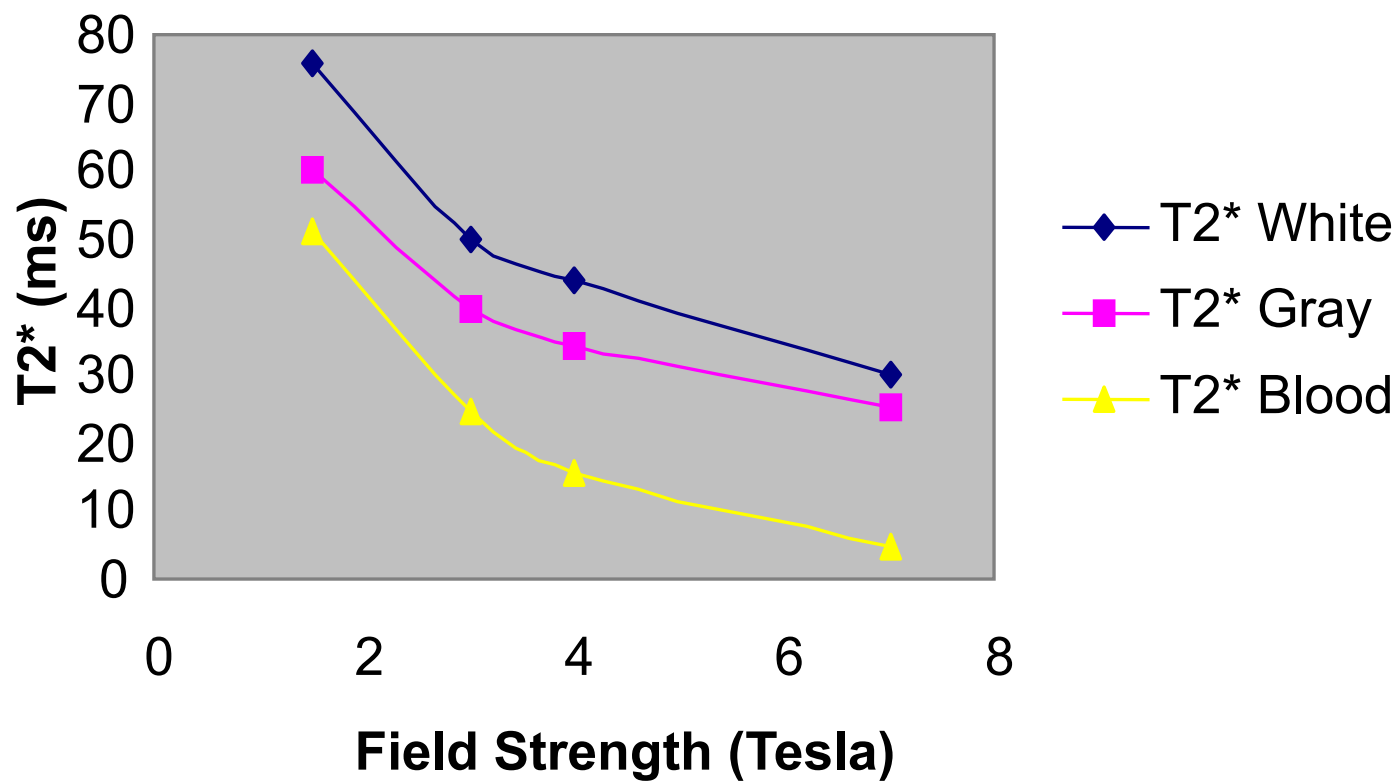

Venograms (3T)

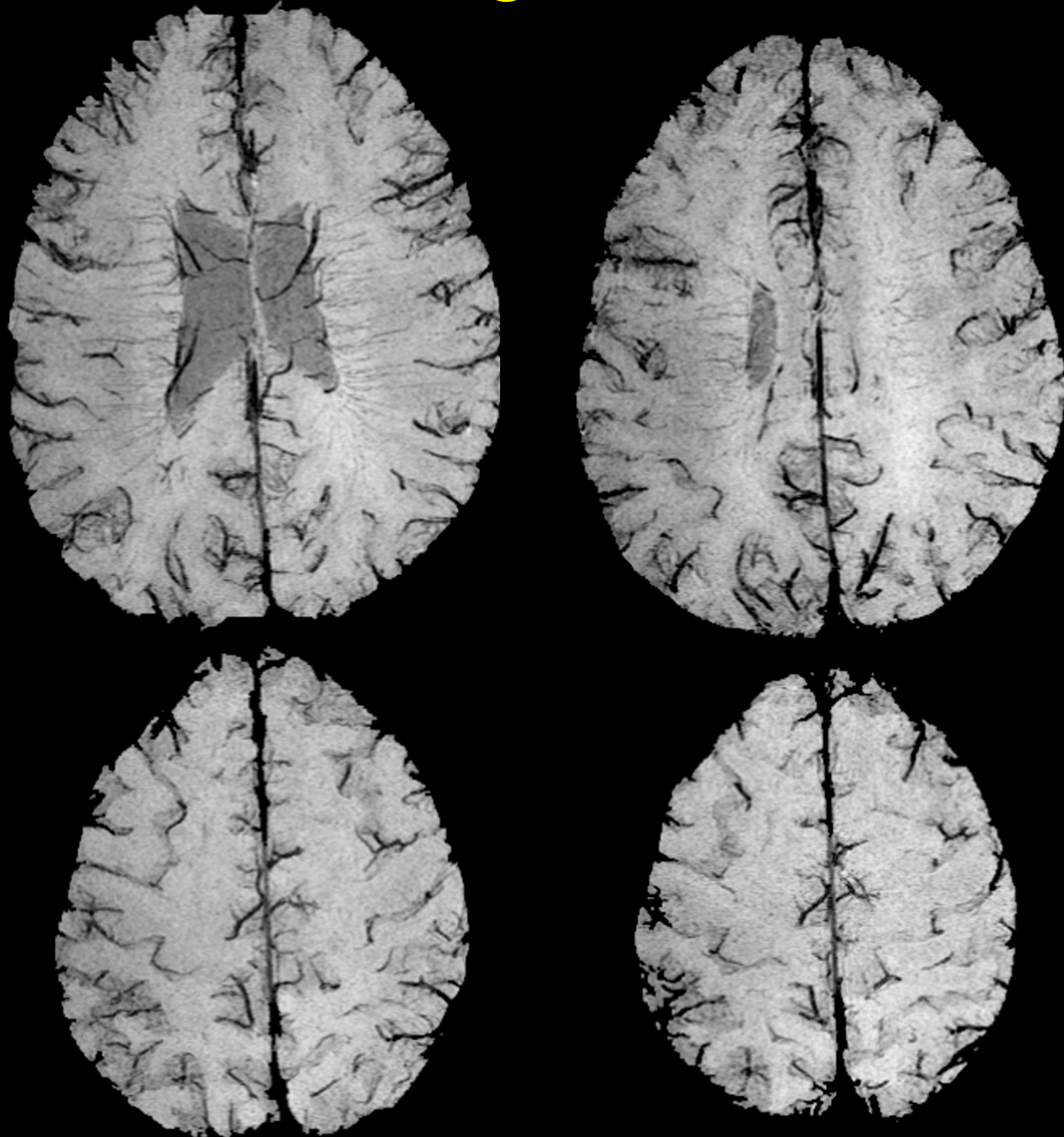

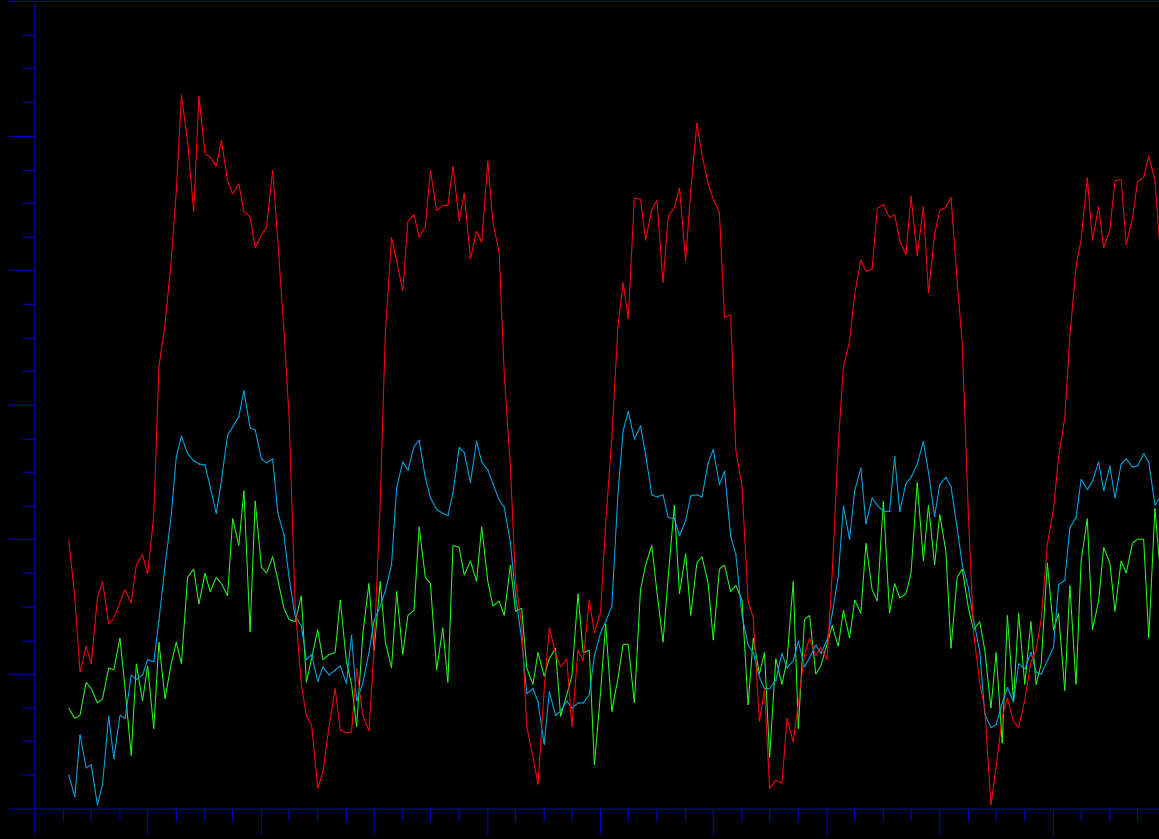

0.5 T

1.5 T

3 T

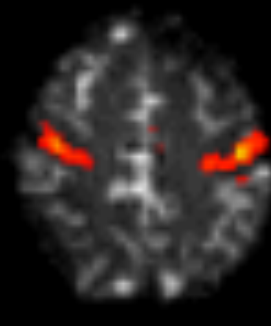
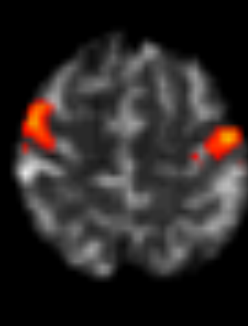
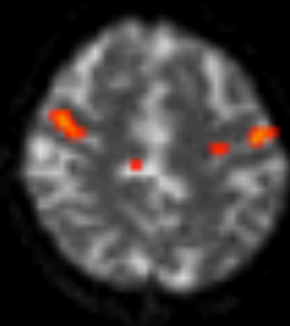
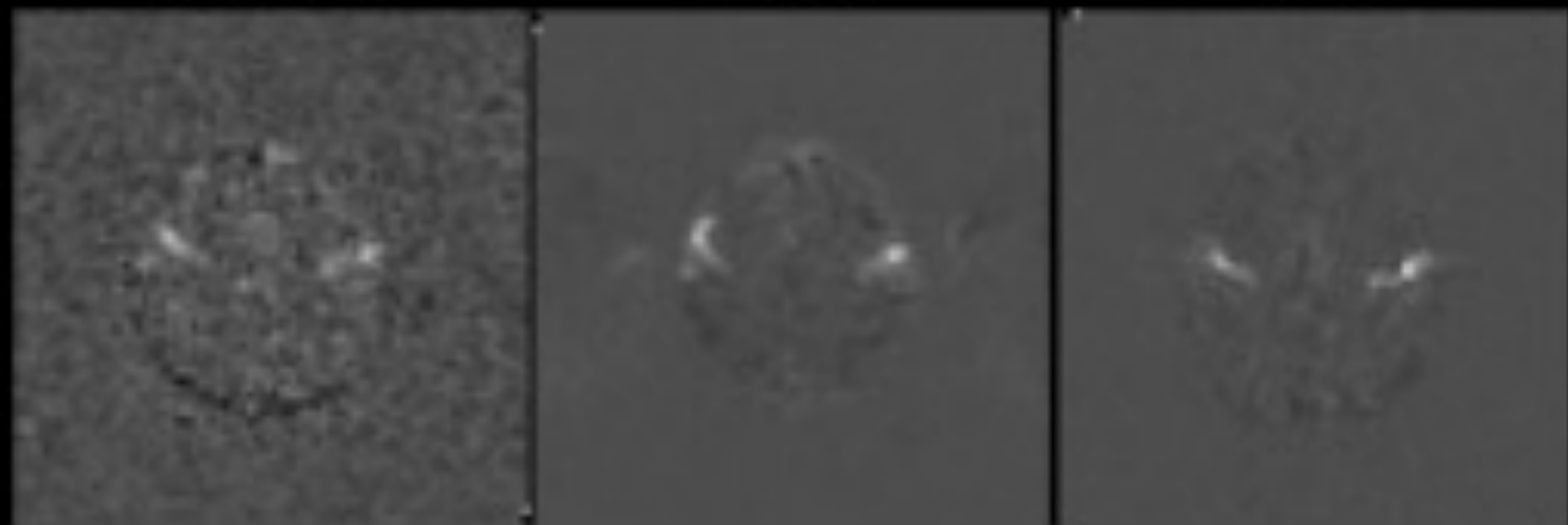

Neuroimaging at 1.5 T and 3.0 T: Comparison of Oxygenation-Sensitive Magnetic Resonance Imaging

Gunnar Krüger,* Andreas Kastrup, and Gary H. Glover

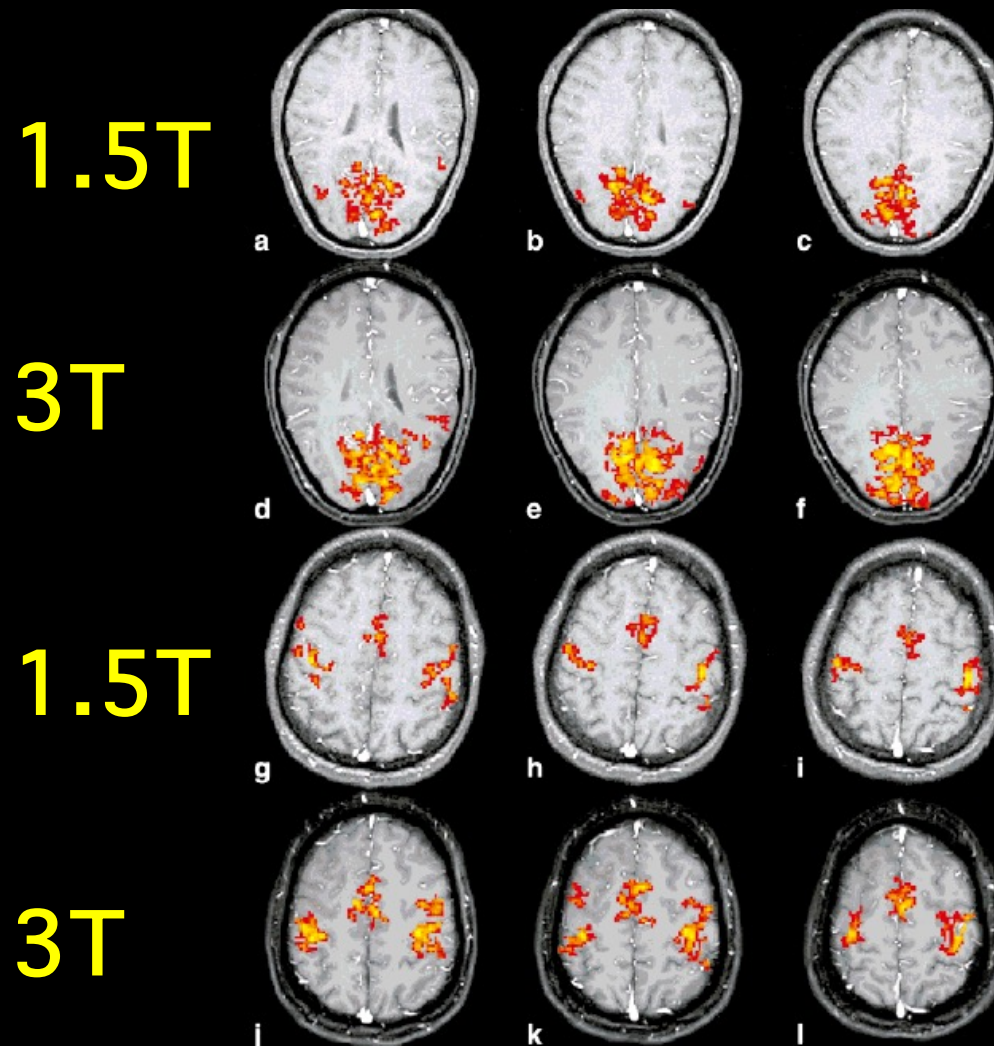

Gradient-Echo EPI

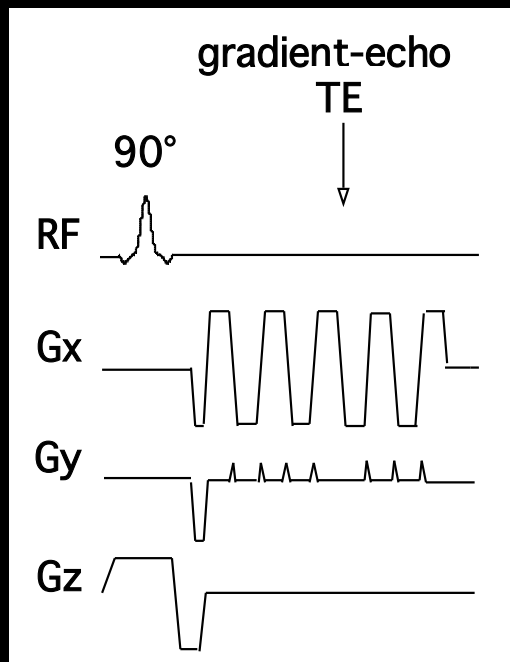

Spin-Echo EPI

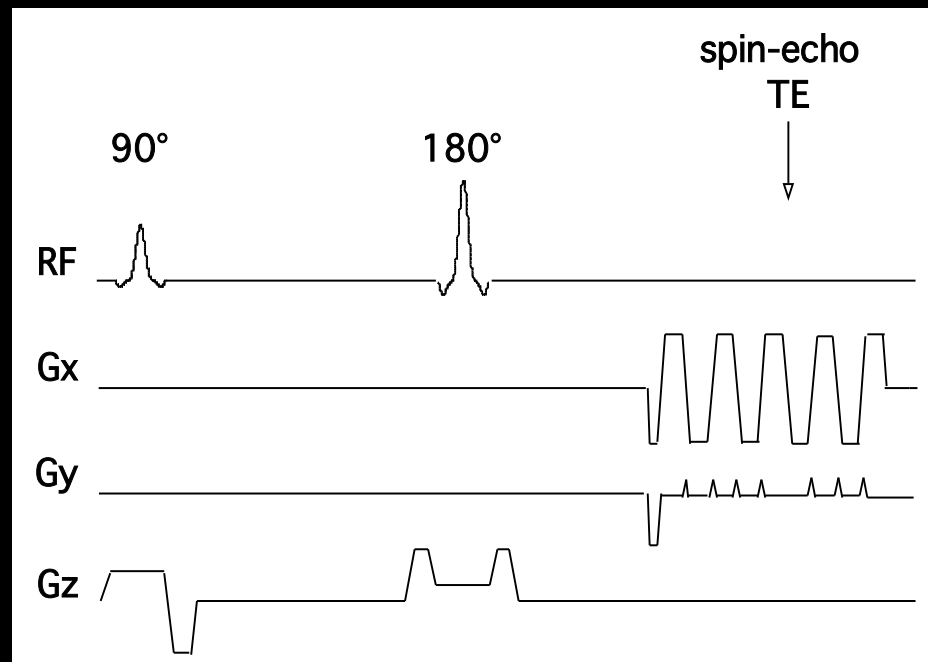

Gradient - Echo

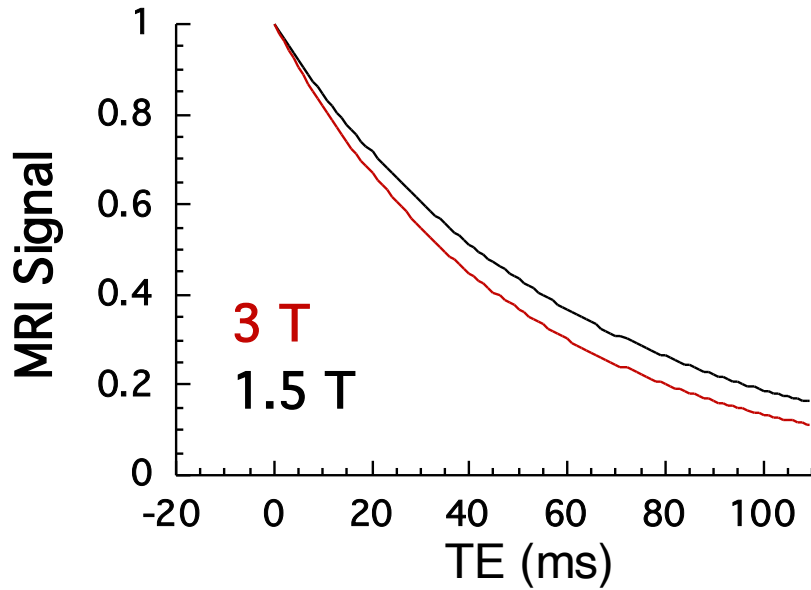

Asymmetric Spin - Echo

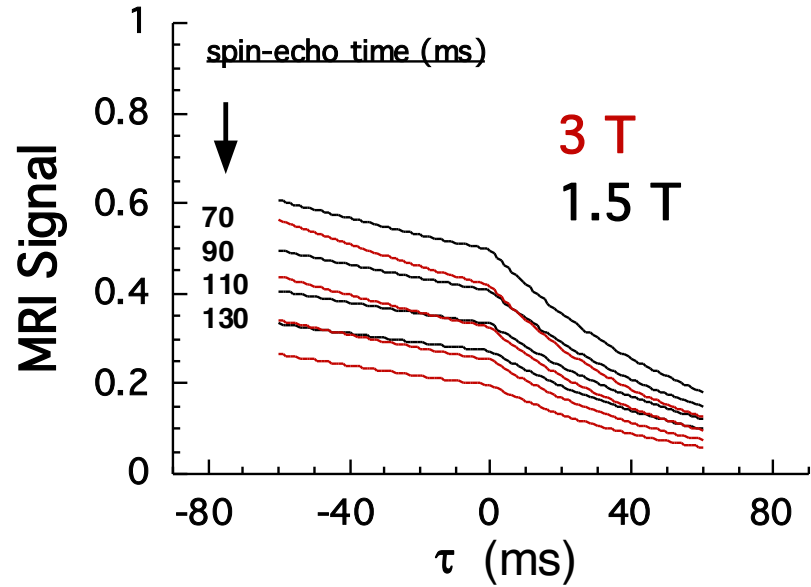

Gradient - Echo

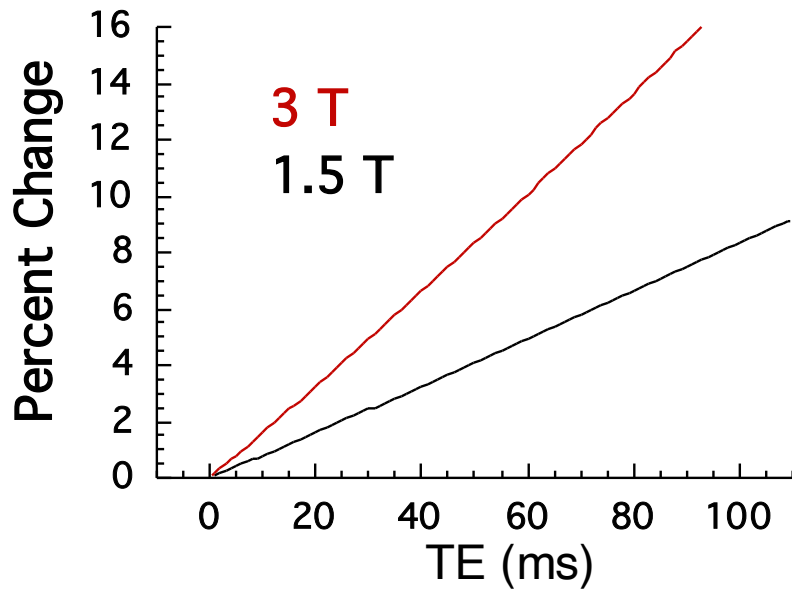

Asymmetric Spin - Echo

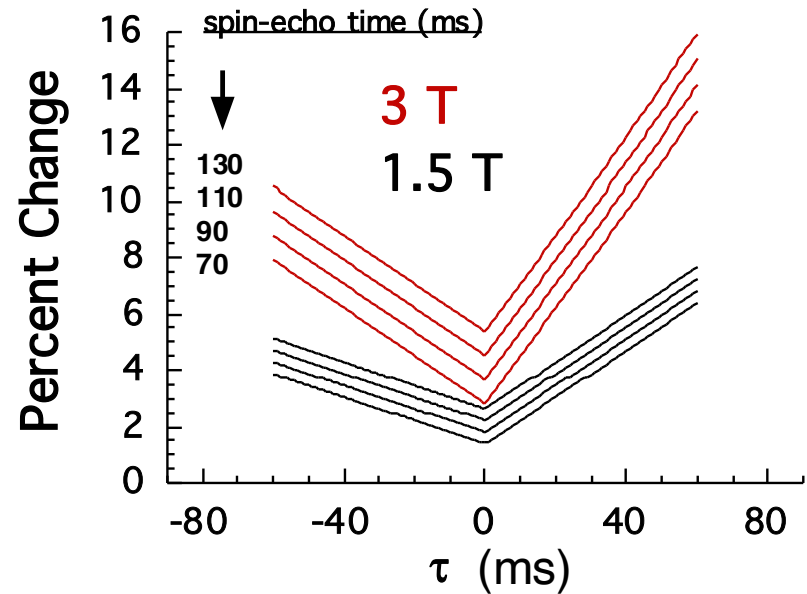

Gradient - Echo

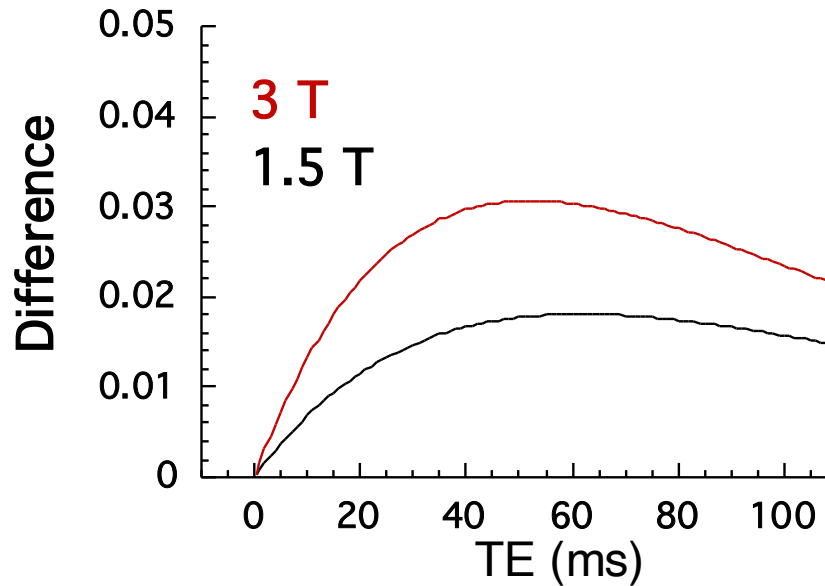

Asymmetric Spin - Echo

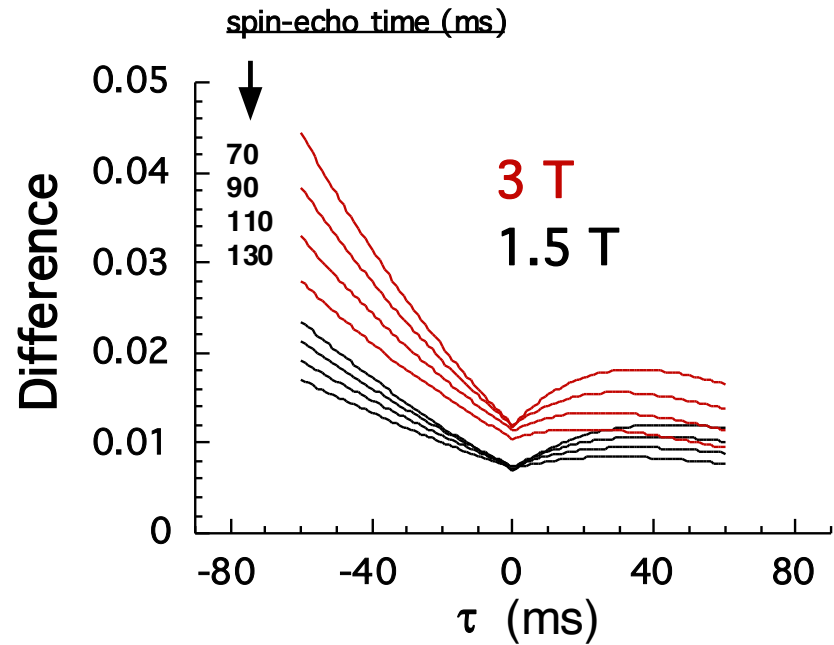

Neuroimaging at 1.5 T and 3.0 T: Comparison of Oxygenation-Sensitive Magnetic Resonance Imaging

Gunnar Krüger,* Andreas Kastrup, and Gary H. Glover

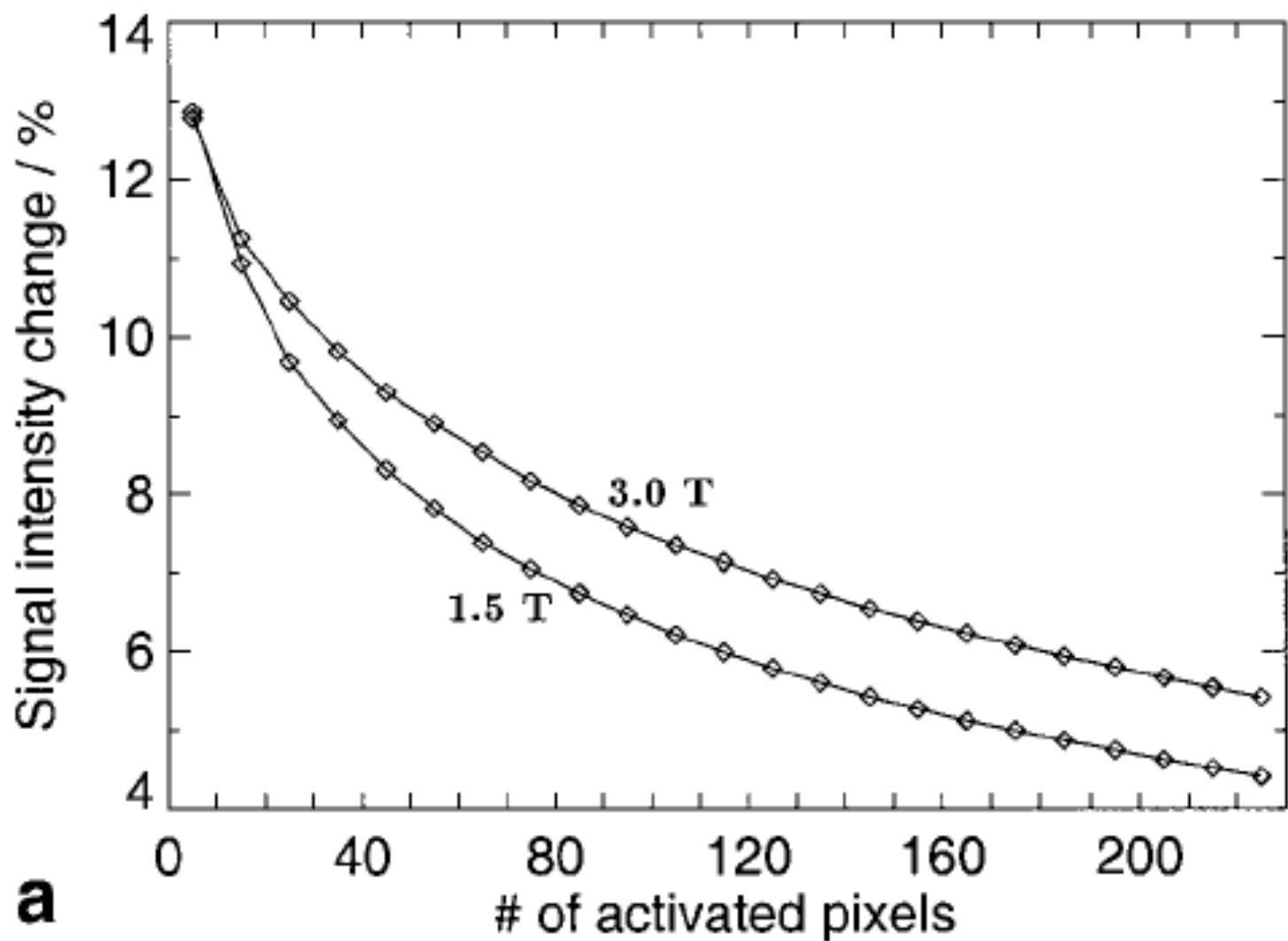

Neuroimaging at 1.5 T and 3.0 T: Comparison of Oxygenation-Sensitive Magnetic Resonance Imaging

Gunnar Krüger,* Andreas Kastrup, and Gary H. Glover

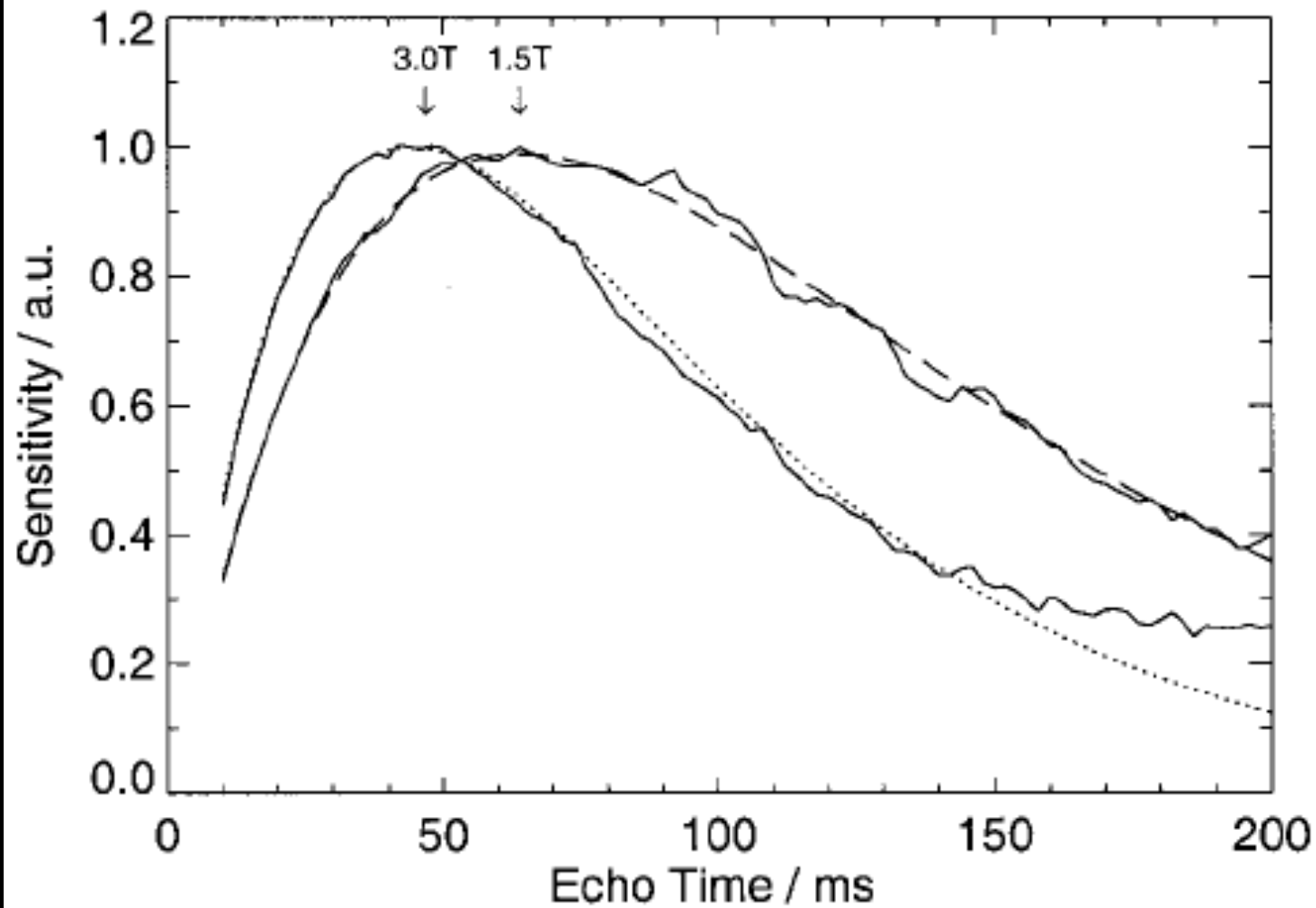

Functional Contrast at Optimal TE

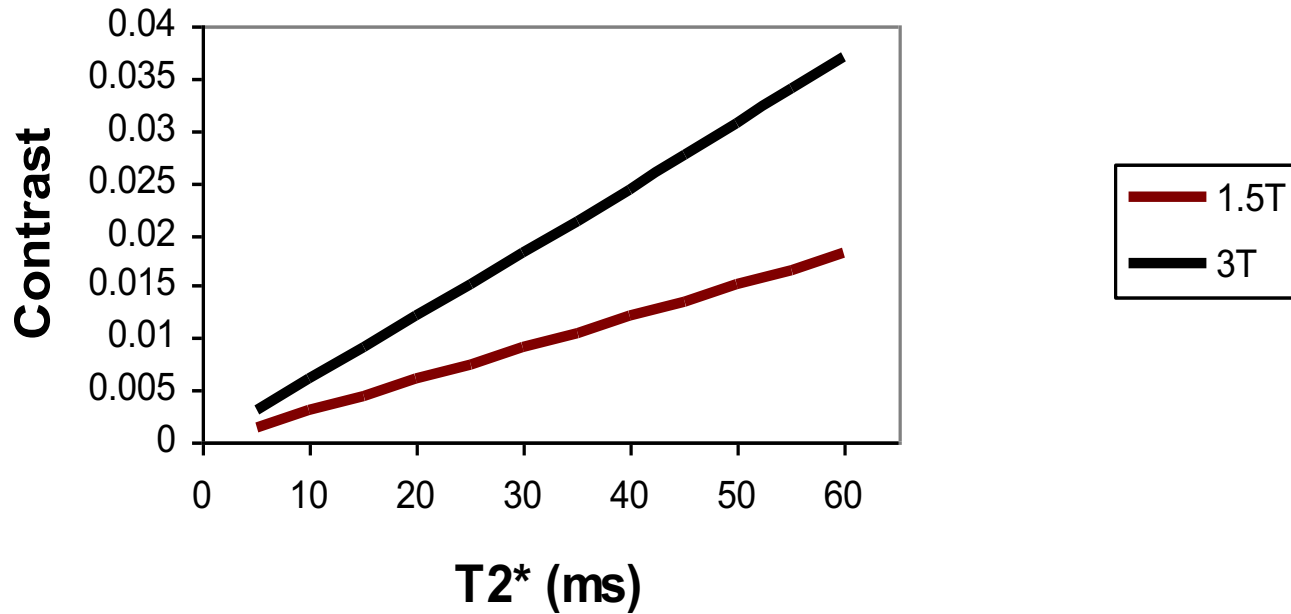

Contrast depends on: activation-induced changes in $T2^*$ *and* resting $T2^*$

$T2^*$

$T2^*$

Contrast at 1.5T ($dR2^* = -.8$ 1/s)

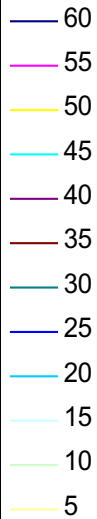
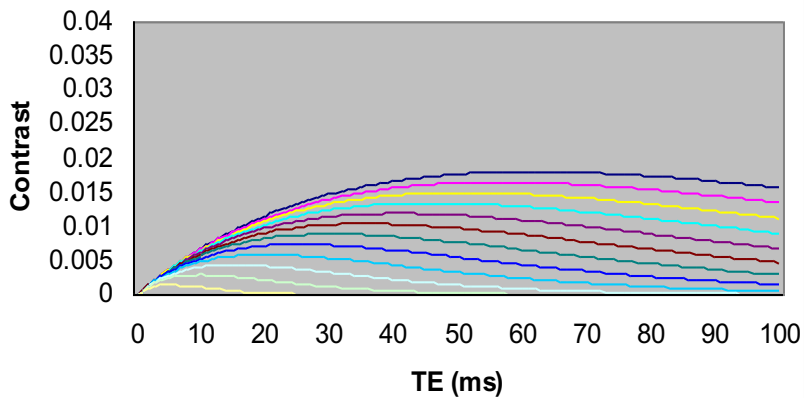

Contrast at 3T ($dR2^* = -1.6$ 1/s)

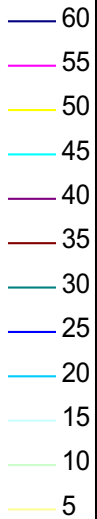
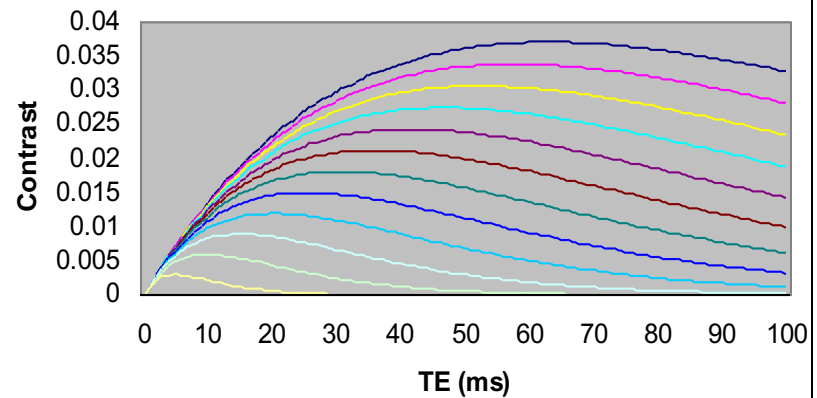

Functional Contrast at Optimal TE

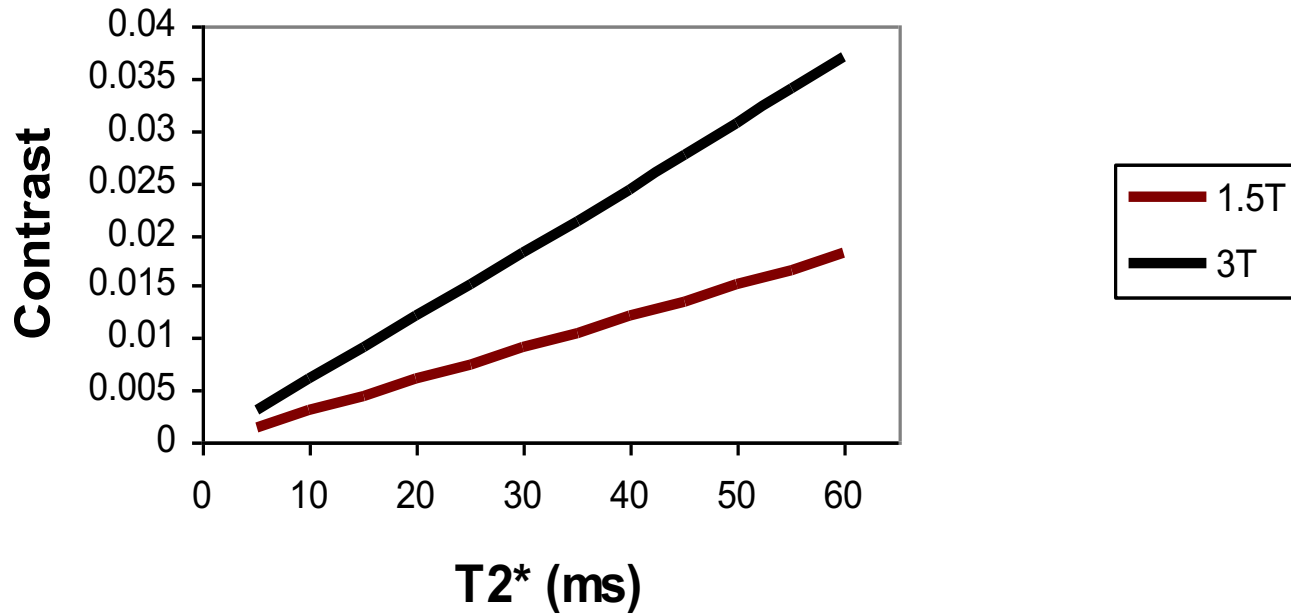

Neuroimaging at 1.5 T and 3.0 T: Comparison of Oxygenation-Sensitive Magnetic Resonance Imaging

Gunnar Krüger,* Andreas Kastrup, and Gary H. Glover

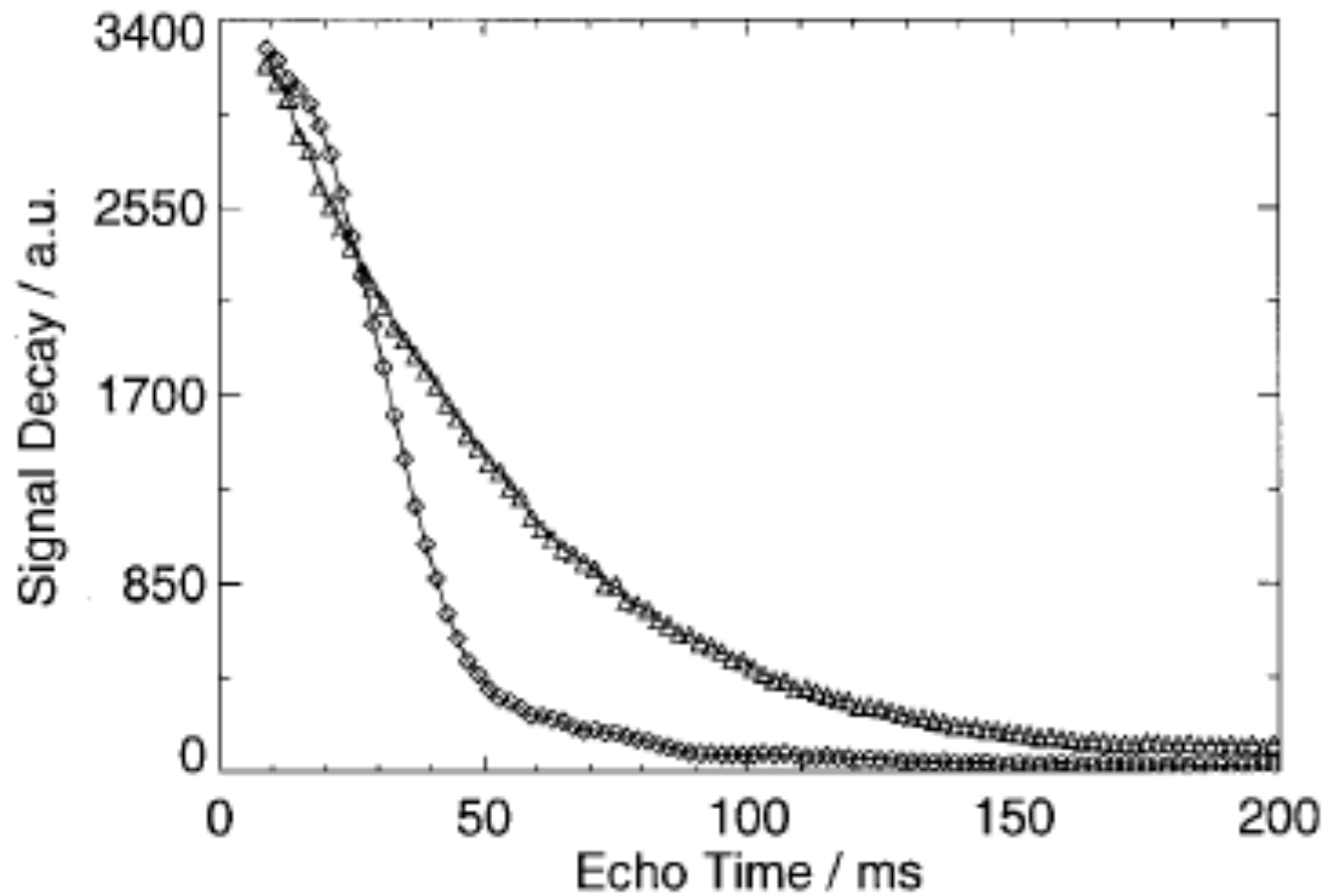

Contrast depends on: activation-induced changes in $T2^*$ *and* resting $T2^*$

$T2^*$

Contrast at 1.5T ($dR2^* = -.8$ 1/s)

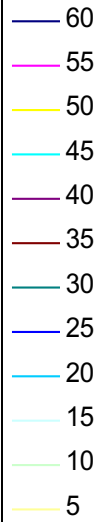
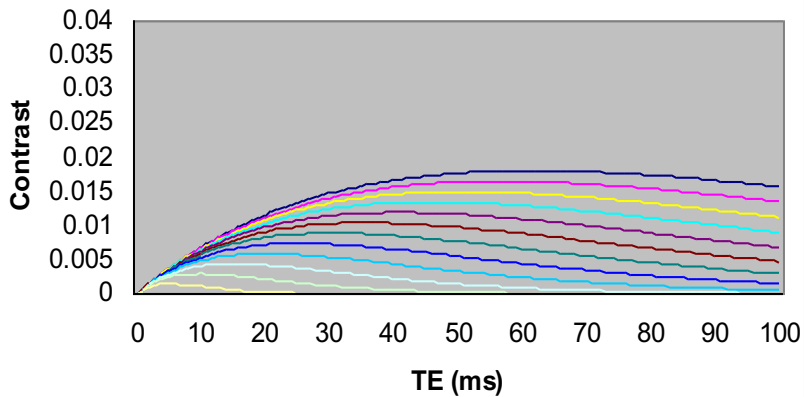

$T2^*$

Contrast at 3T ($dR2^* = -1.6$ 1/s)

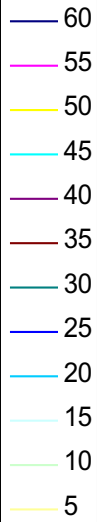
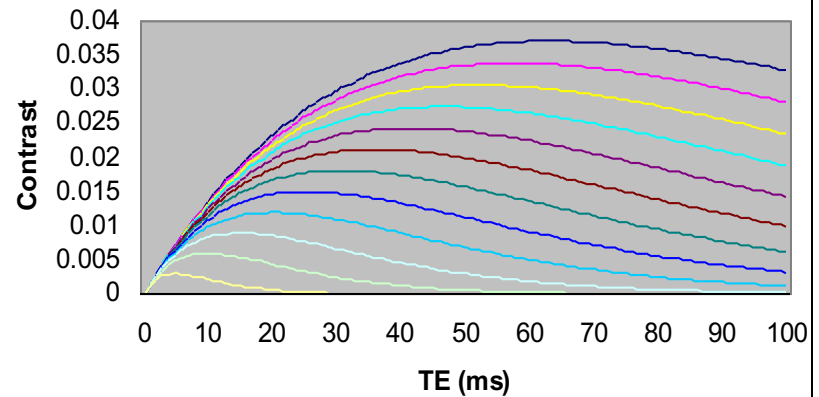

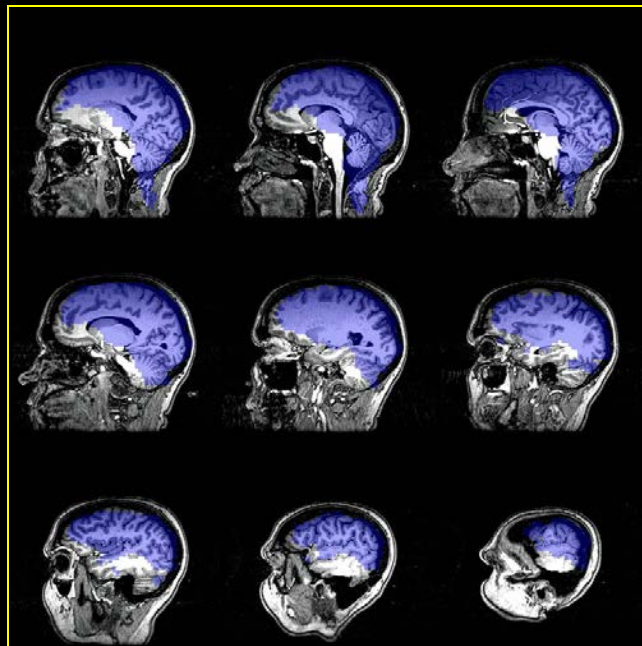
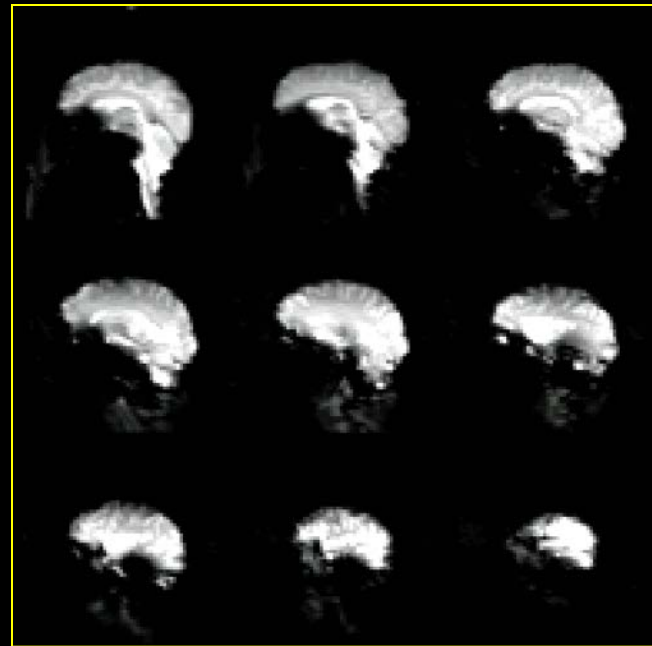
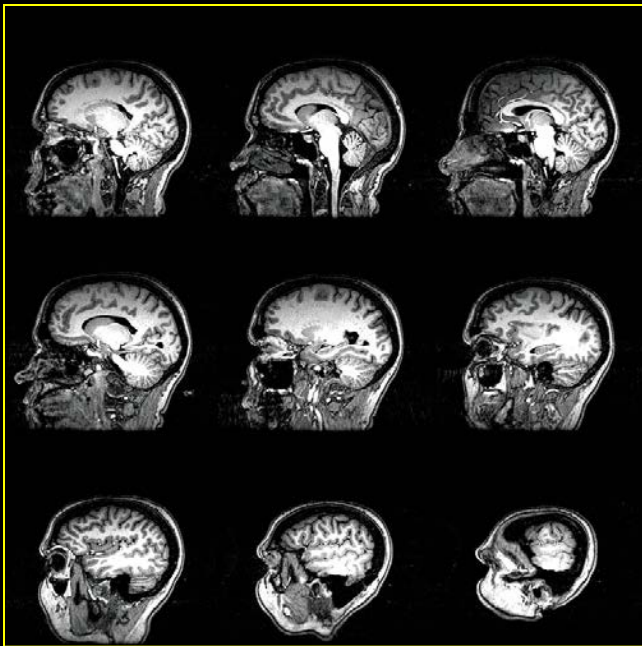

3D z-Shim Method for Reduction of Susceptibility Effects in BOLD fMRI

Gary H. Glover*

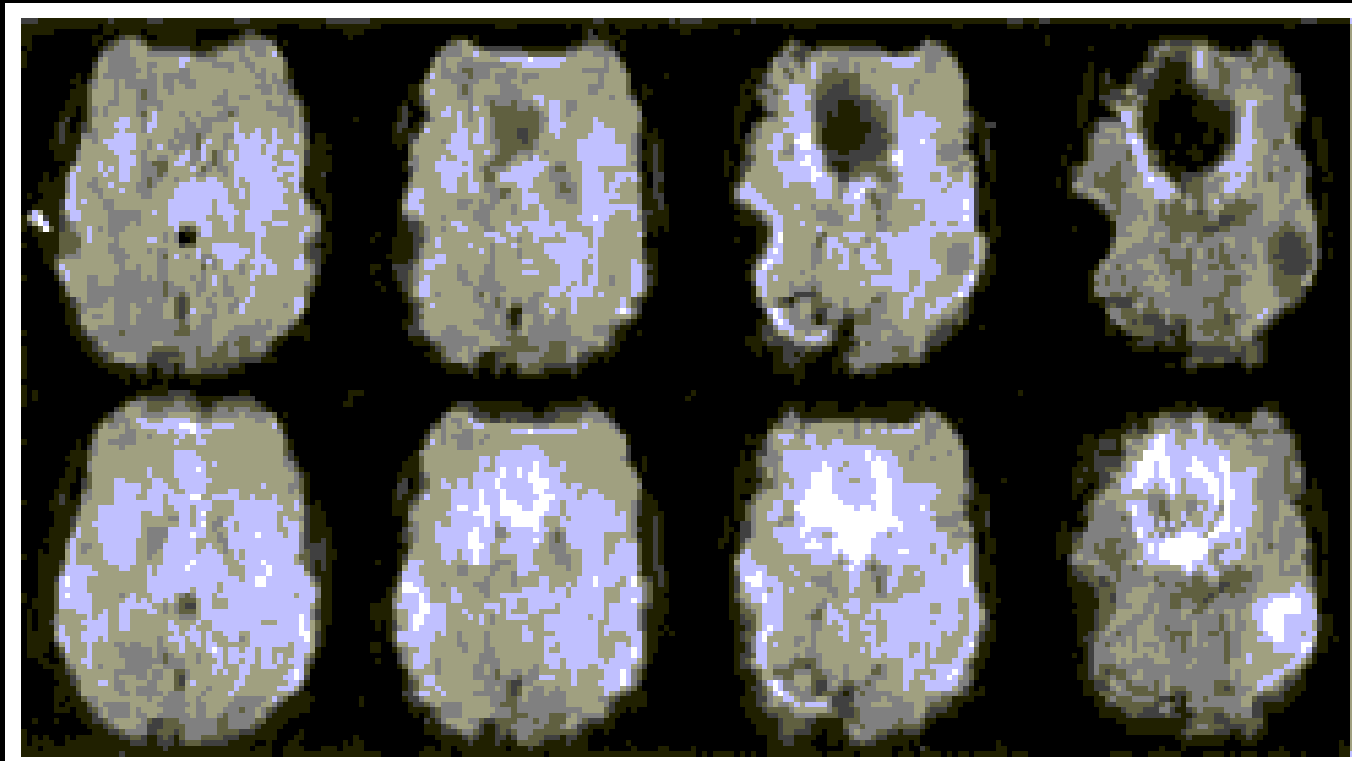

Arterial inflow
(BOLD TR < 500 ms)

Perfusion

BOLD

Venous inflow
(for ASL, w/ no VN)

No
Velocity
Nulling

Velocity
Nulling

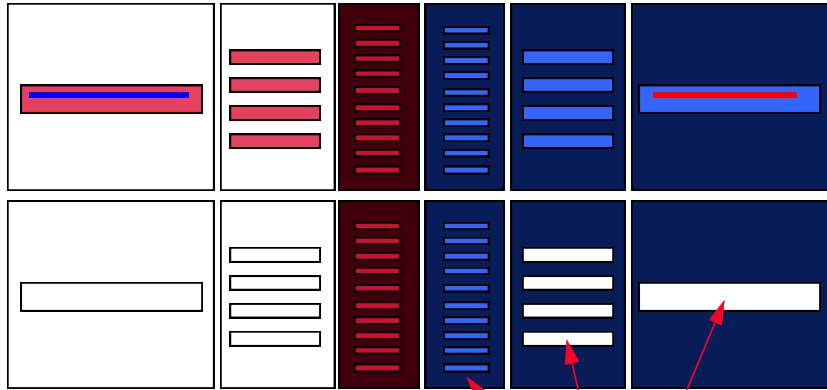

Pulse Sequence Sensitivity

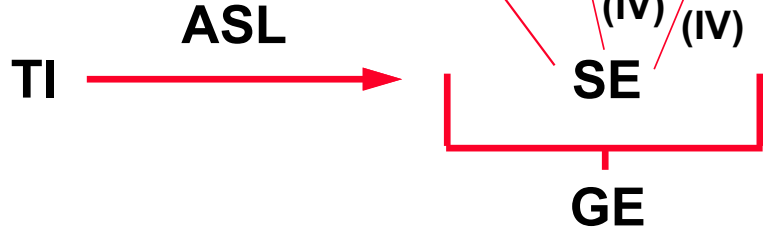
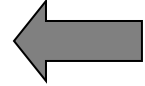

Spatial Heterogeneity

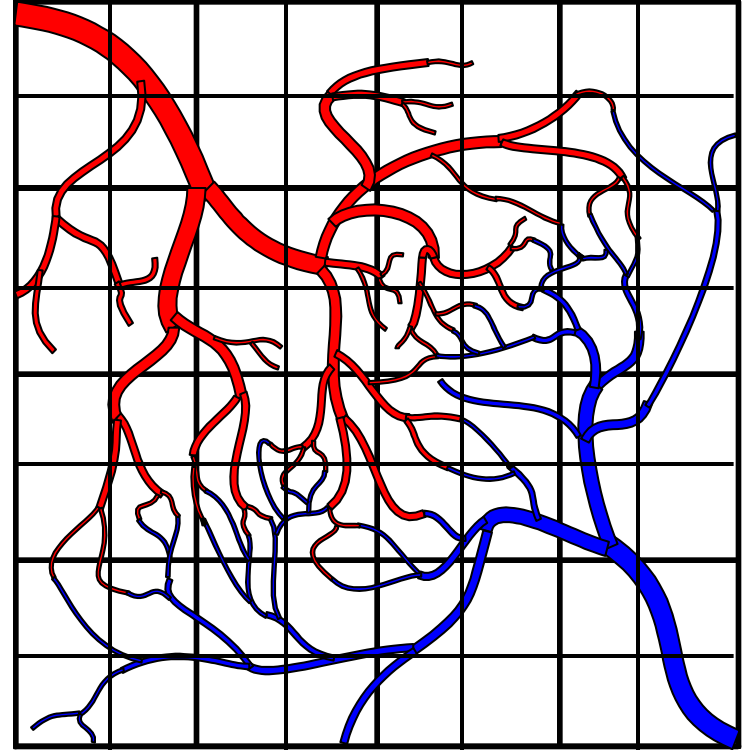
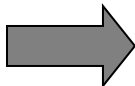

A few slides about Image Resolution and Noise...

Multishot Imaging



EPI Window 1

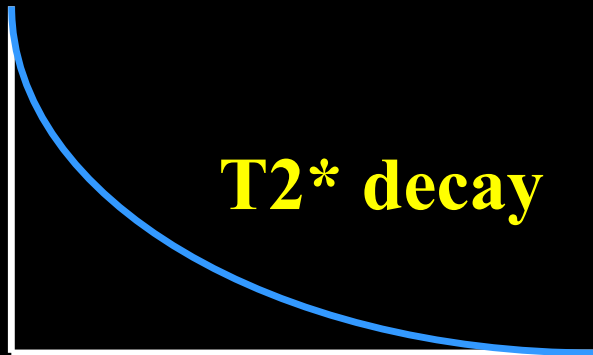

EPI Window 2

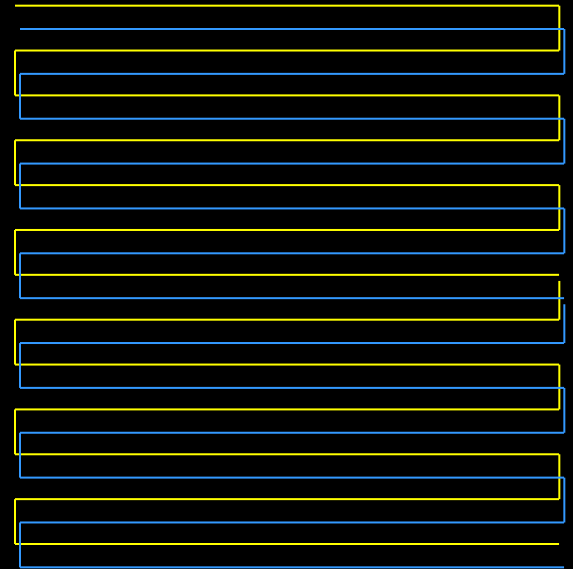

Multi Shot EPI

Excitations
Matrix Size

1

64 x 64

2

128 x 128

4

256 x 128

8

256 x 256

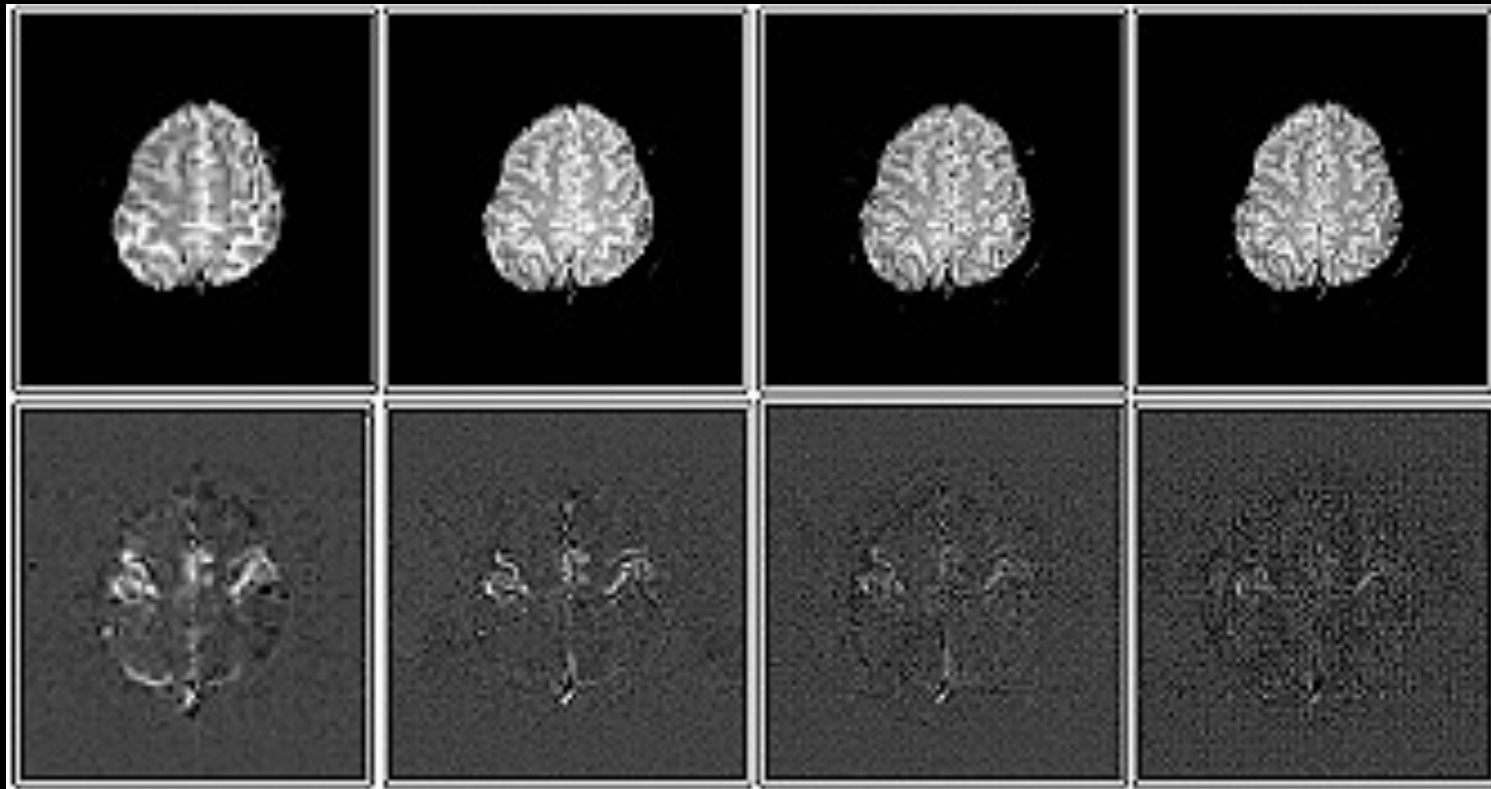

Partial k-space imaging

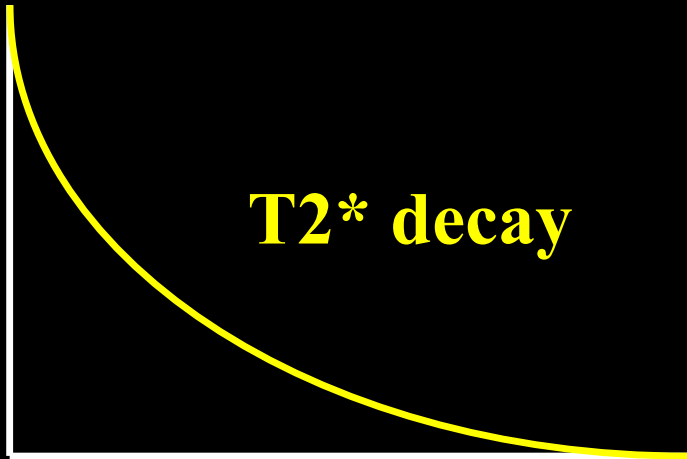

EPI Window

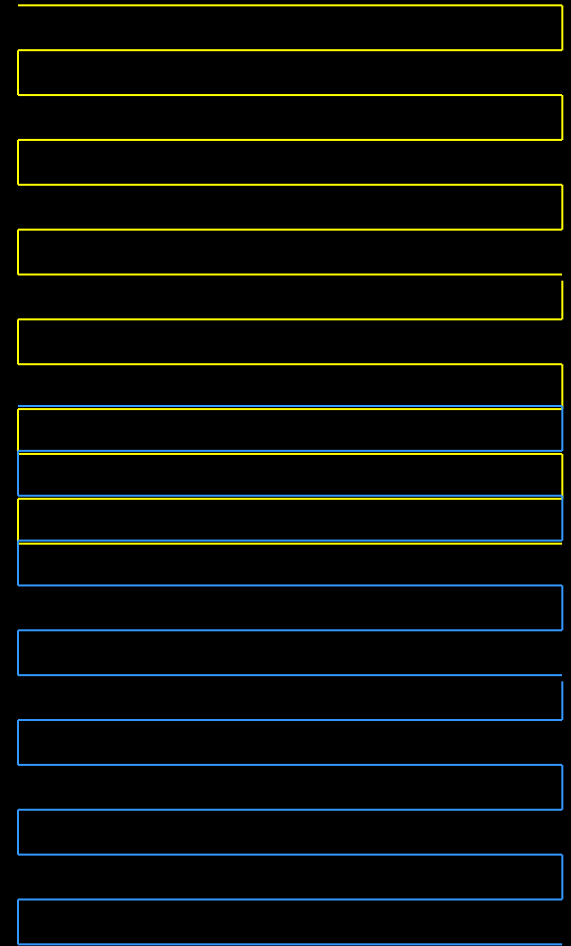

Partial k-space imaging

Fractional Signal Change

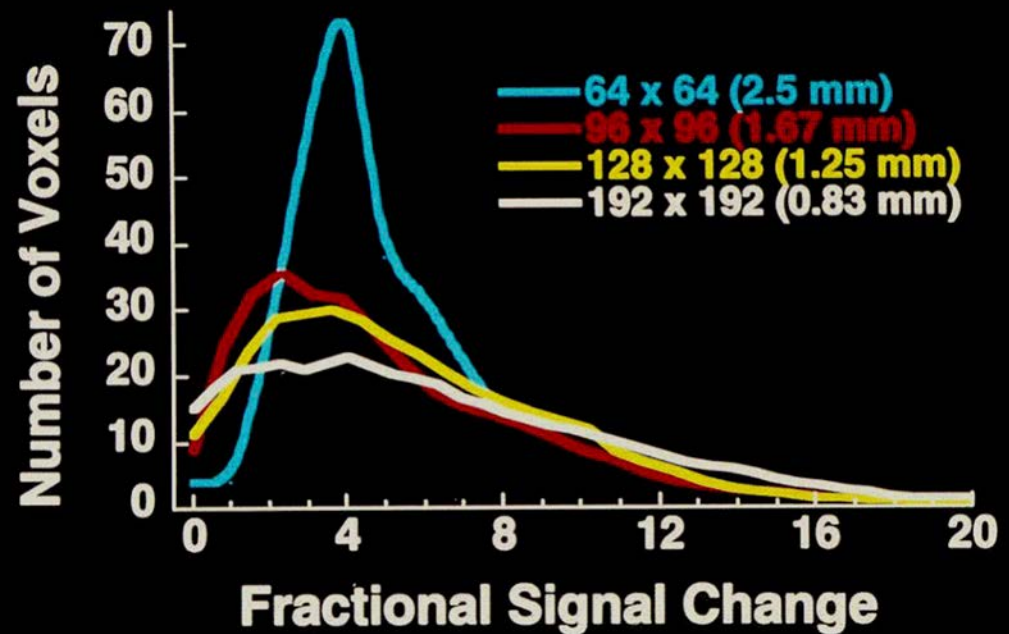
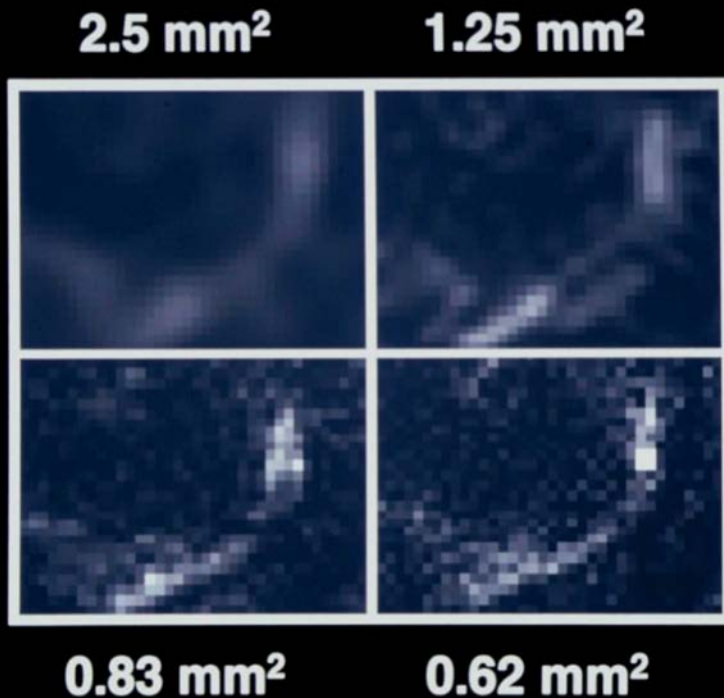

Jesmanowicz, P. A. Bandettini, J. S. Hyde, (1998) "Single shot half k-space high resolution EPI for fMRI at 3T." *Magn. Reson. Med.* 40, 754-762.

Temporal vs. Spatial SNR- 3T

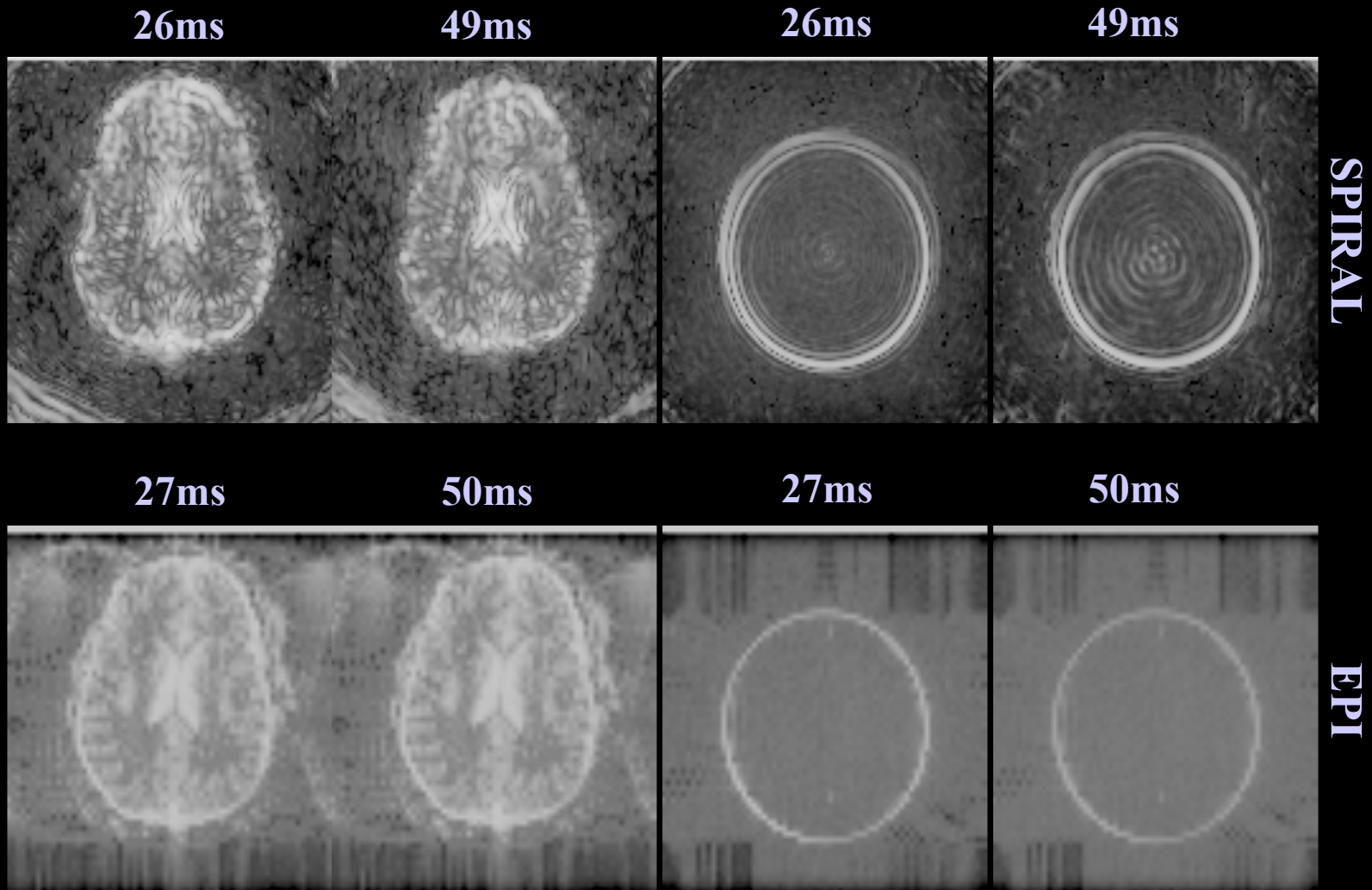

0.25 Hz Breathing at 3T

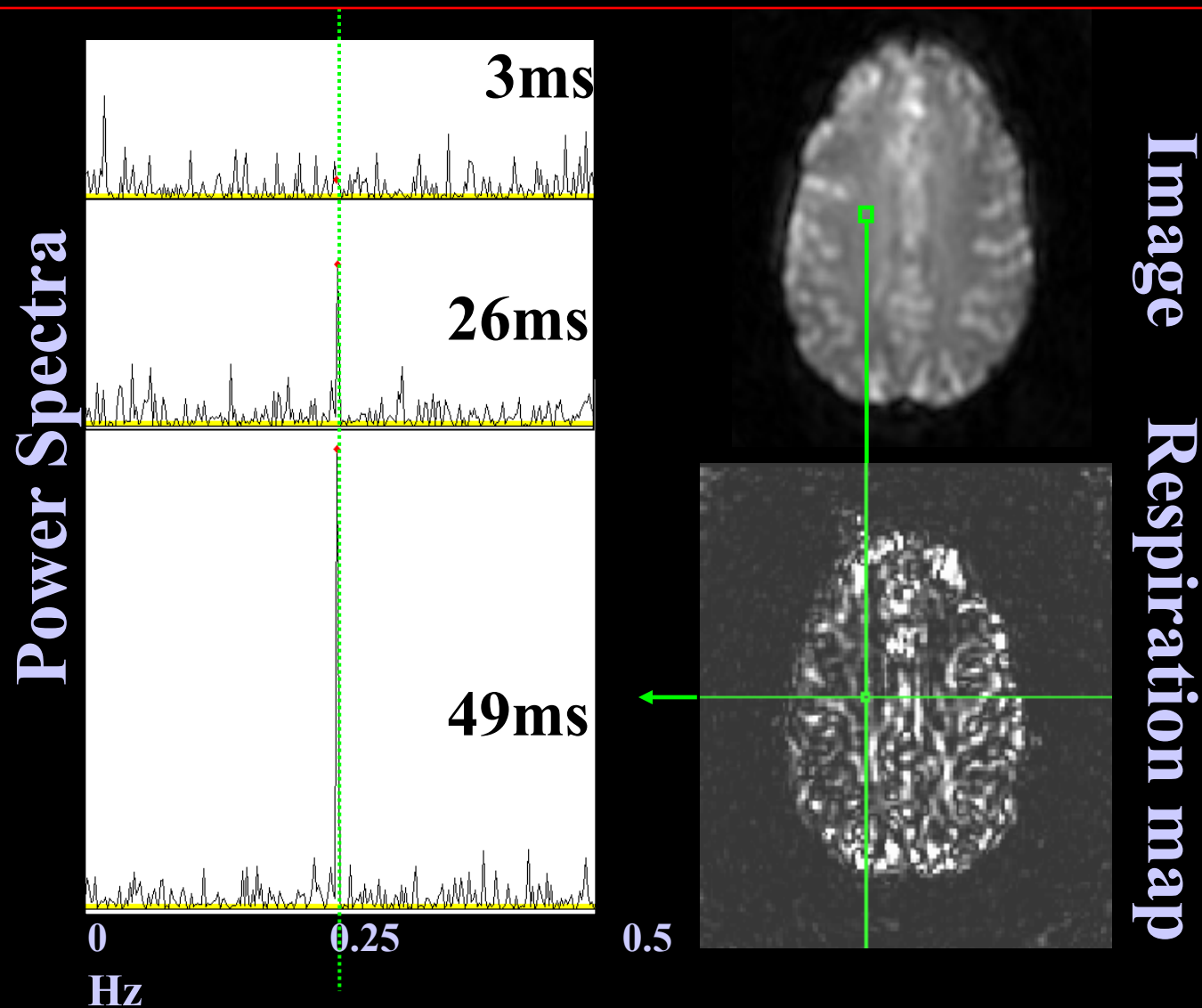

0.68 Hz Cardiac rate at 3T

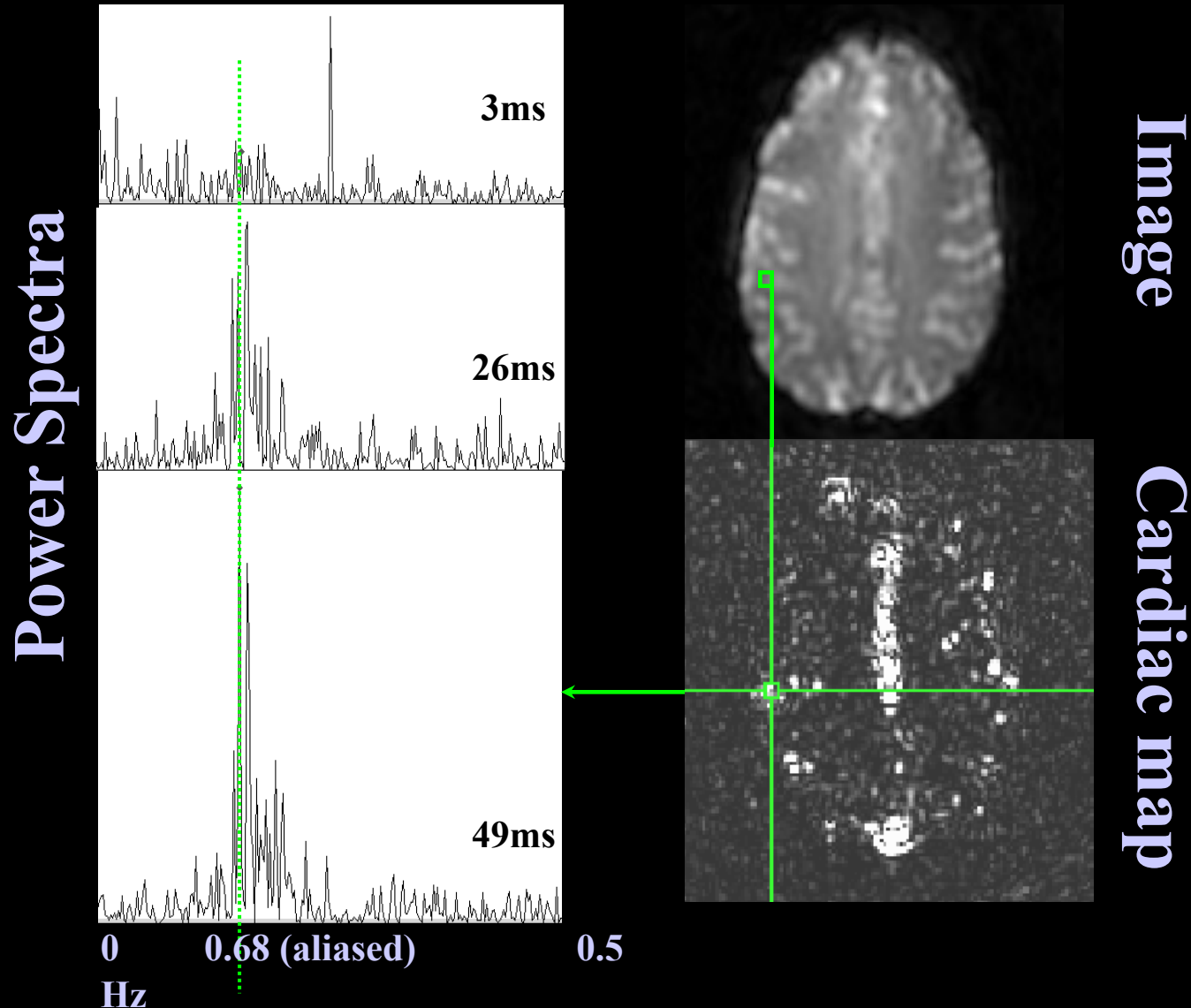

Temporal S/N vs. Image S/N

PHANTOMS

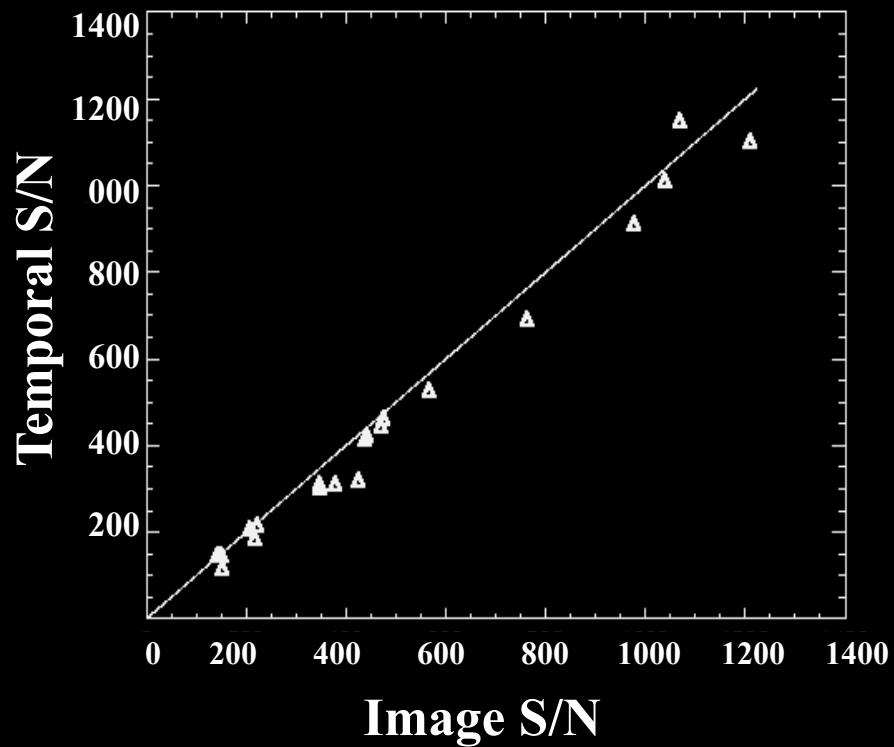

SUBJECTS

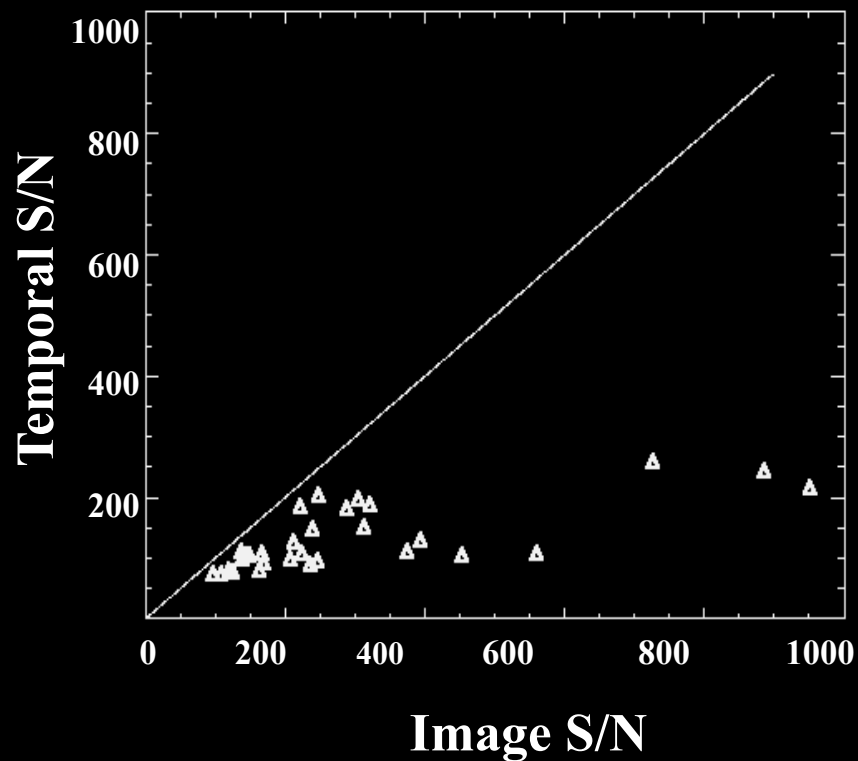

Neuroimaging at 1.5 T and 3.0 T: Comparison of Oxygenation-Sensitive Magnetic Resonance Imaging

Gunnar Krüger,* Andreas Kastrup, and Gary H. Glover

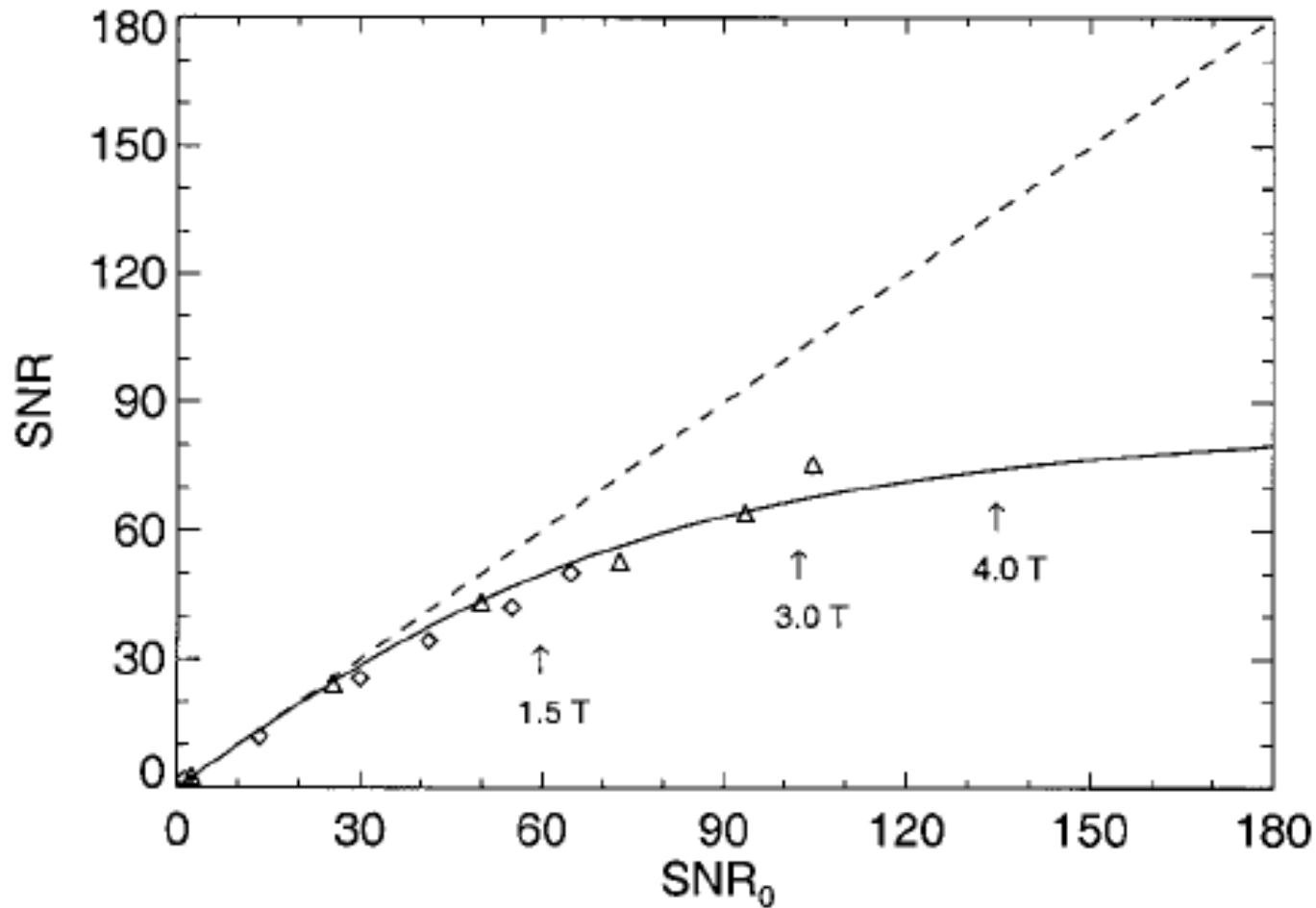

Temporal vs. Image S/N Optimal Resolution Study

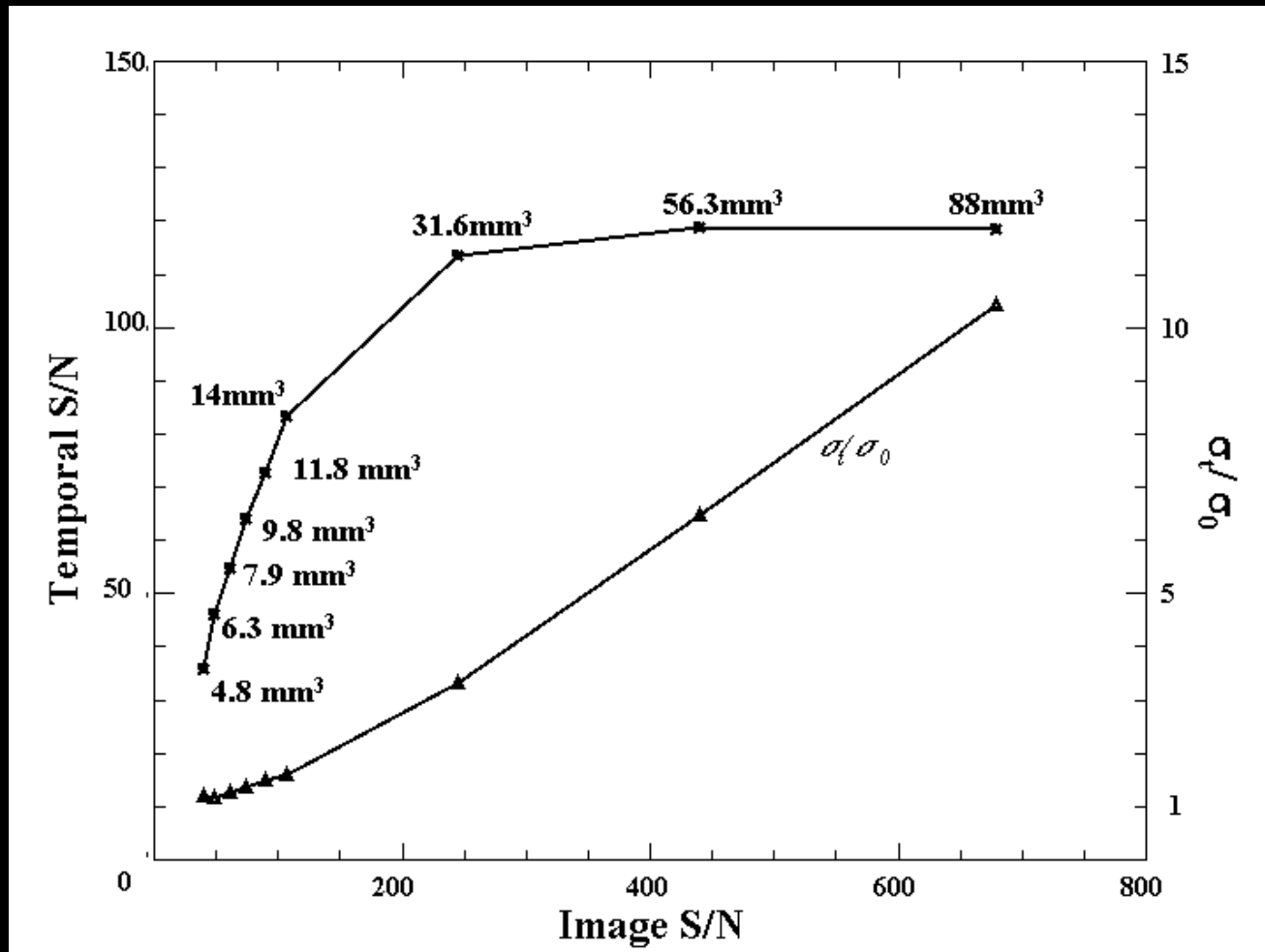

Human data

Petridou et al

Temporal vs. Image S/N Optimal Resolution Study

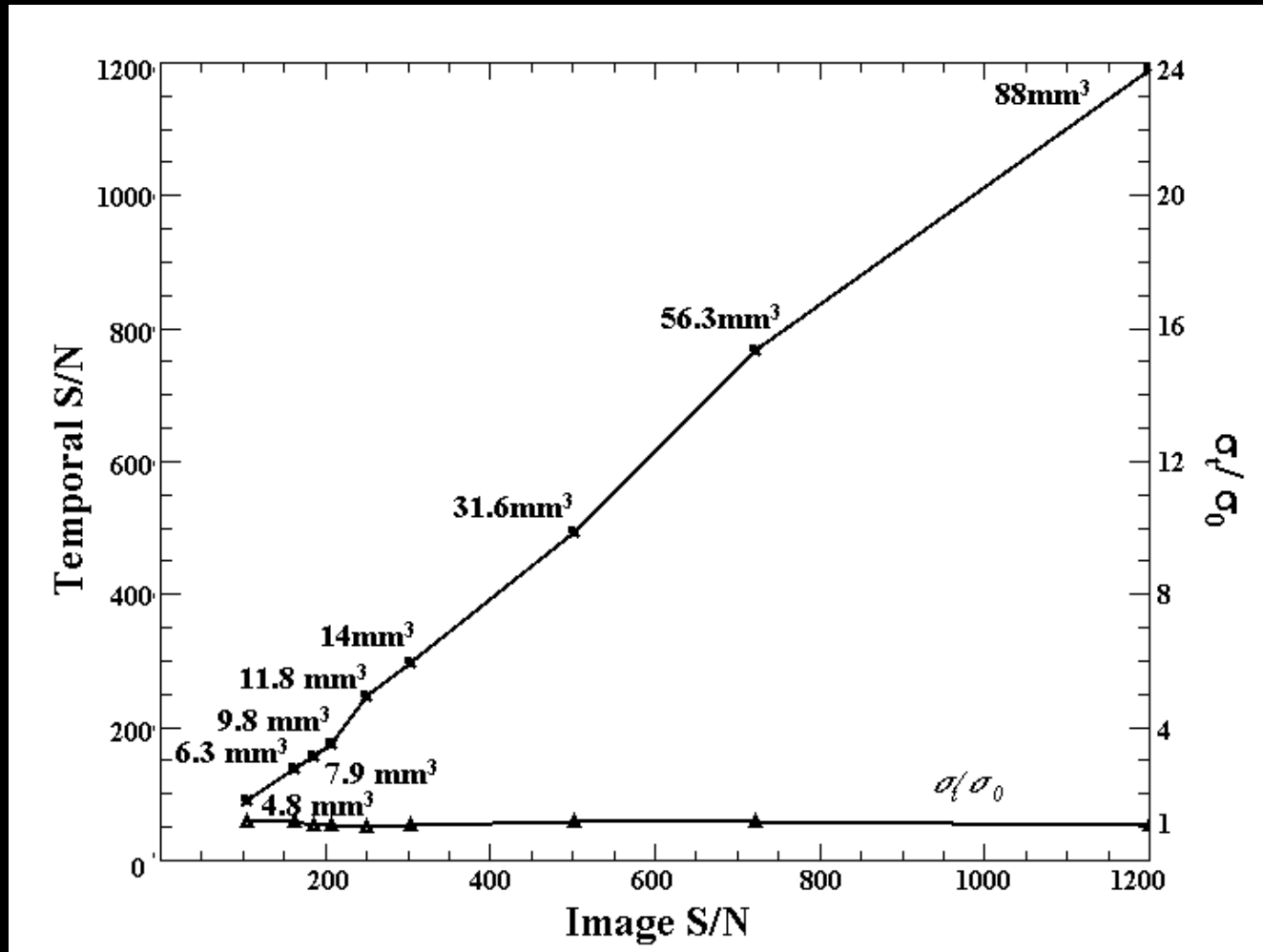

Phantom data

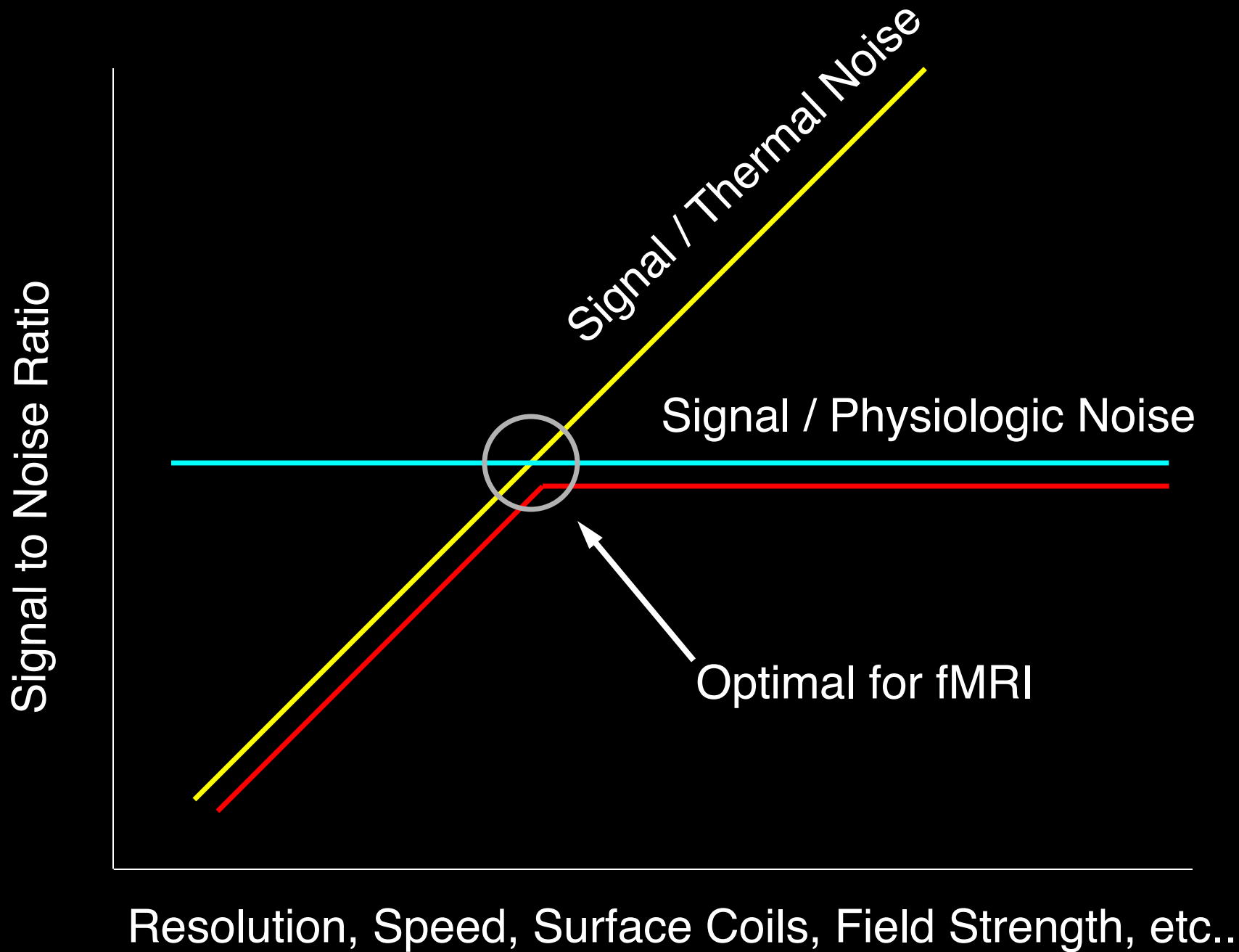

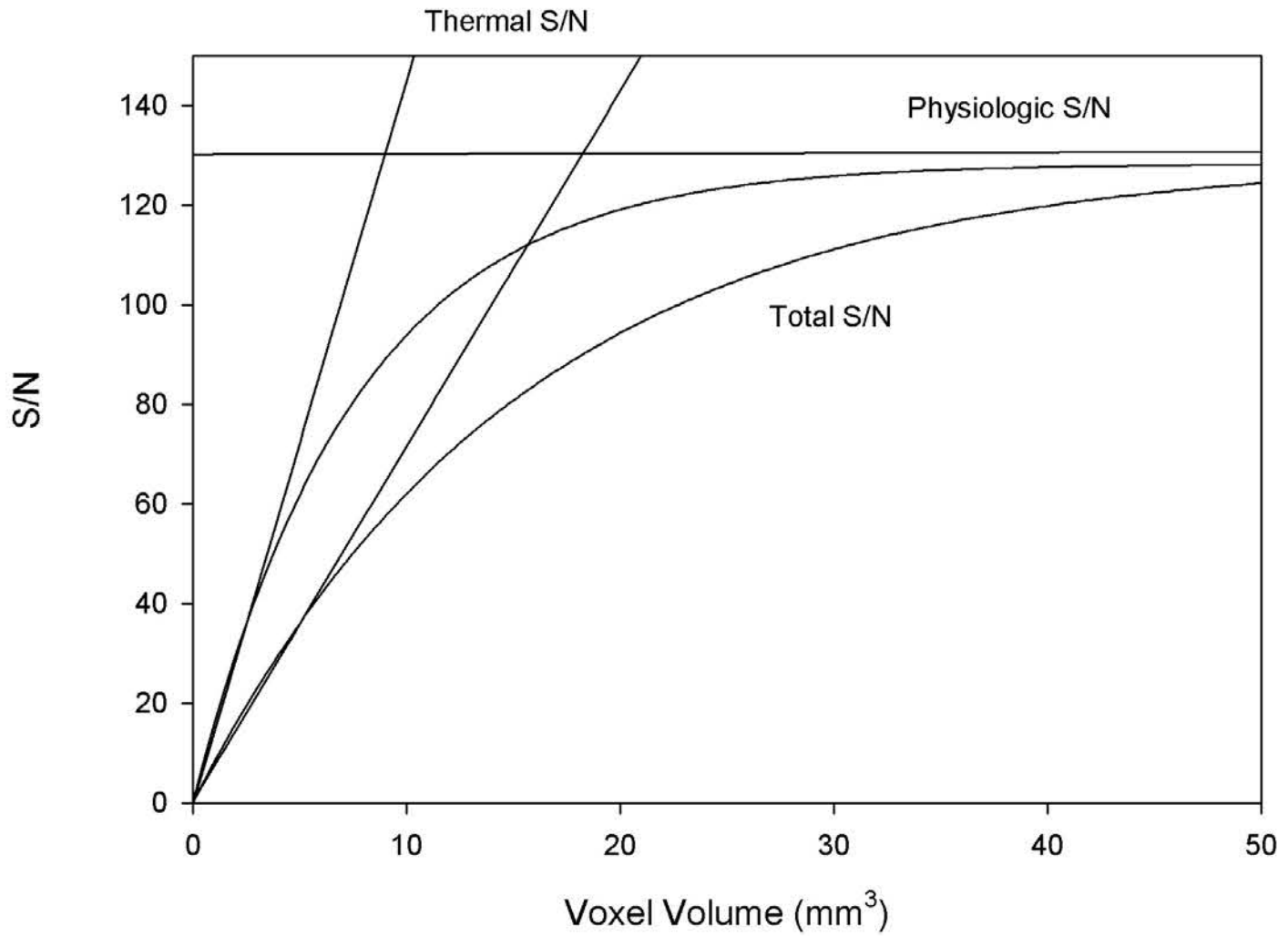

Ocular Dominance Column Mapping using fMRI

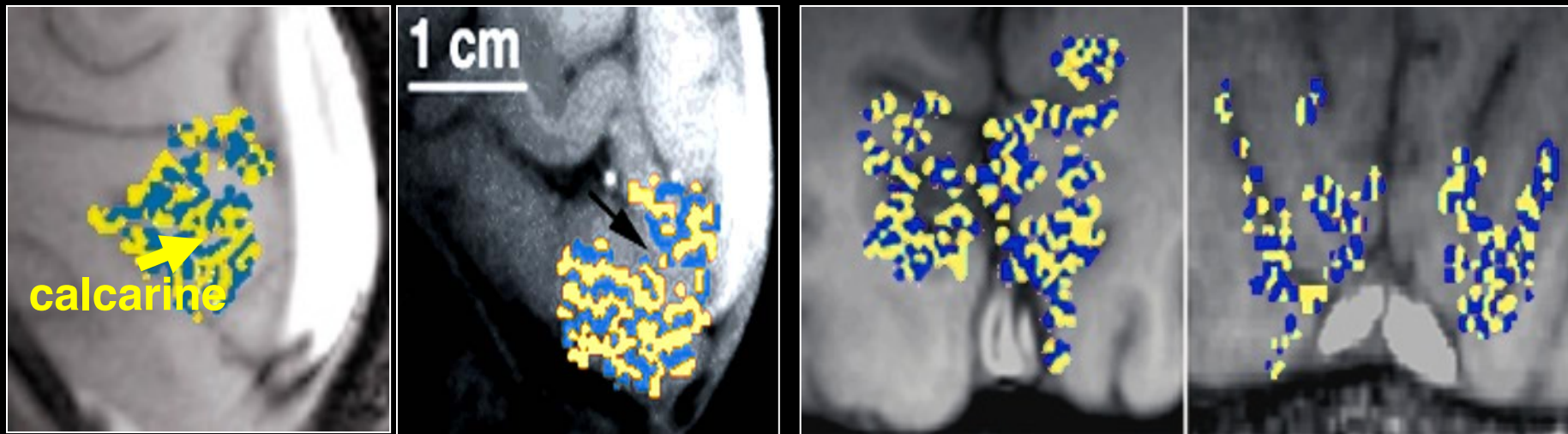

Menon, R. S., S. Ogawa, et al. (1997). "Ocular dominance in human V1 demonstrated by functional magnetic resonance imaging." *J Neurophysiol* 77(5): 2780-7.

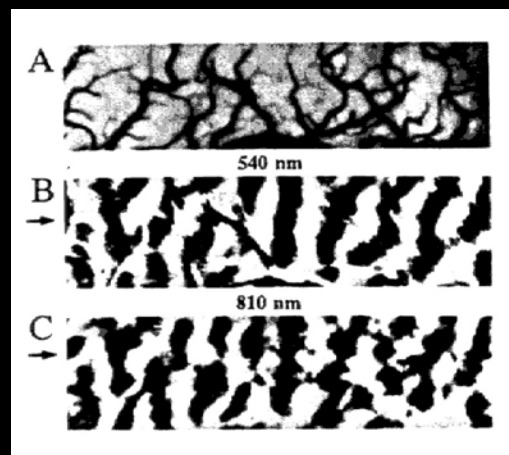

Optical Imaging

R. D. Frostig et. al, PNAS 87: 6082-6086, (1990).

Human Ocular Dominance Columns as Revealed by High-Field Functional Magnetic Resonance Imaging

Kang Cheng,¹ R. Allen Waggoner, and Keiji Tanaka

Laboratory for Cognitive Brain Mapping
RIKEN Brain Science Institute and
CREST

Japan Science and Technology Corporation
2-1 Hirosawa
Wako, Saitama 351-0198
Japan

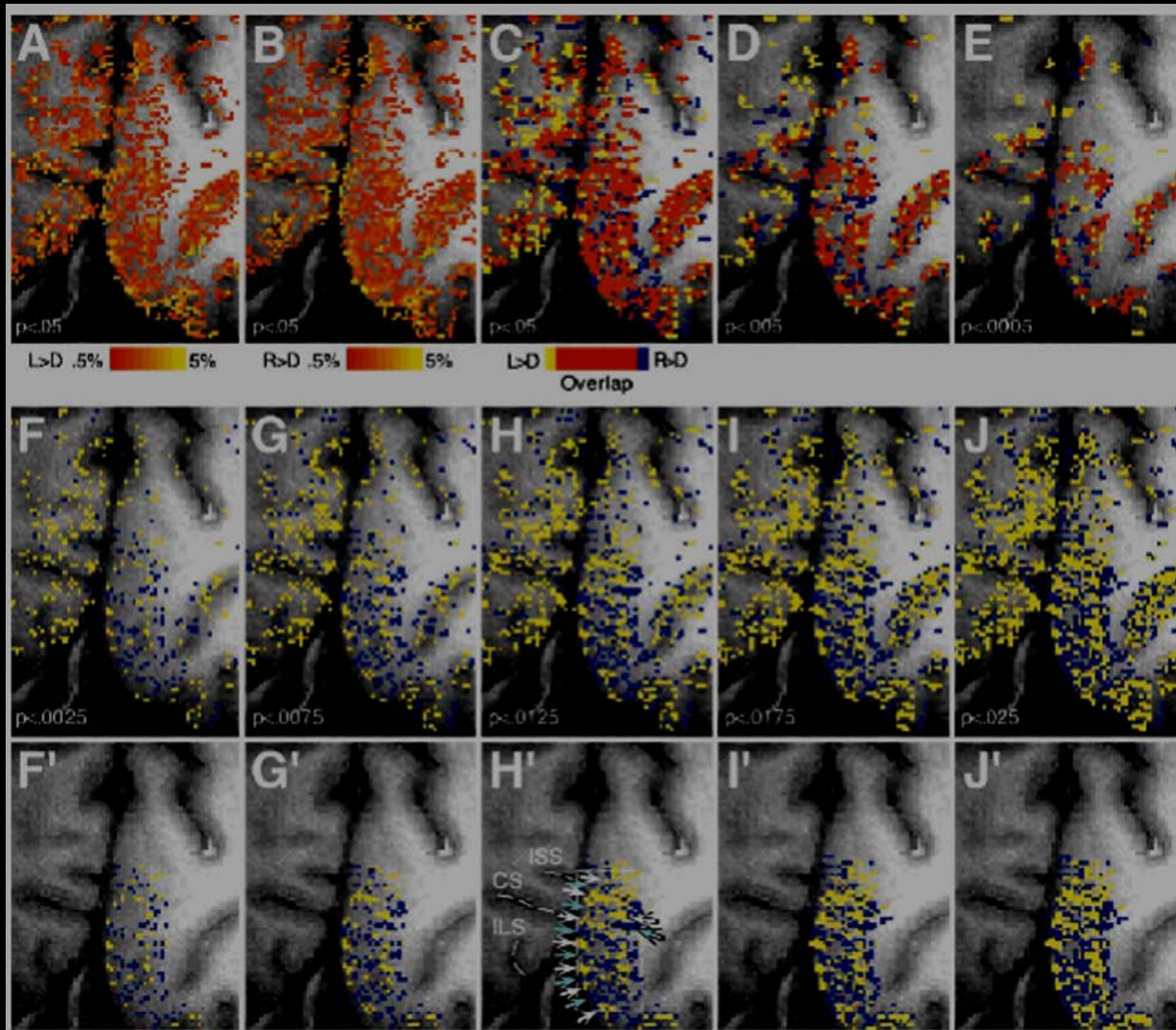

Continuously Growing Activation Area

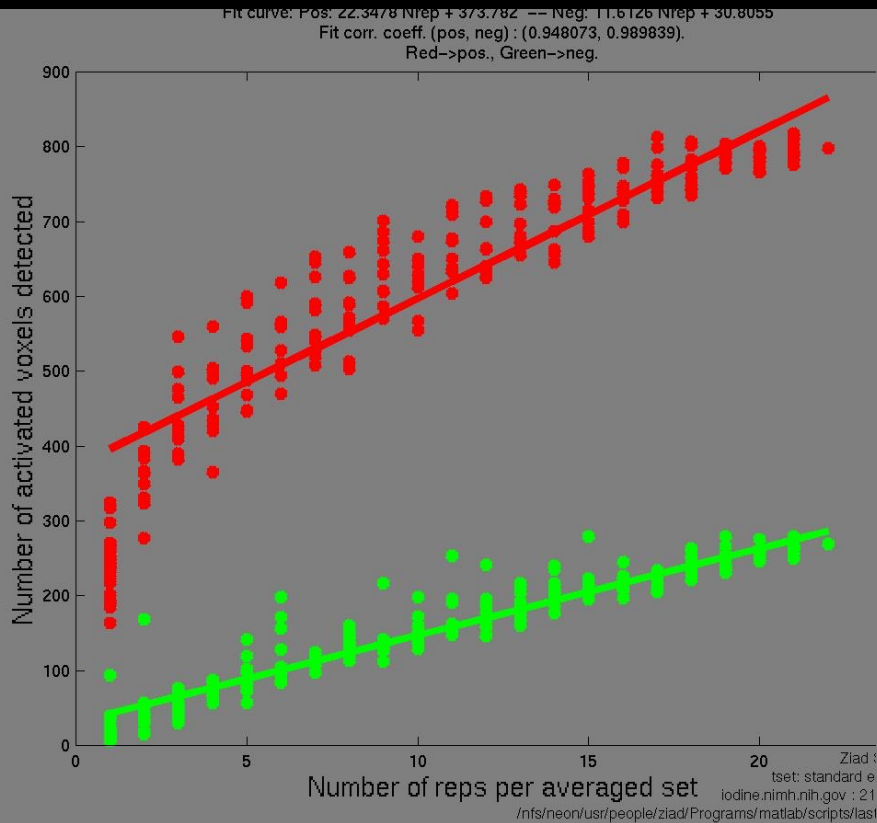

CC Histogram

Inflection Point

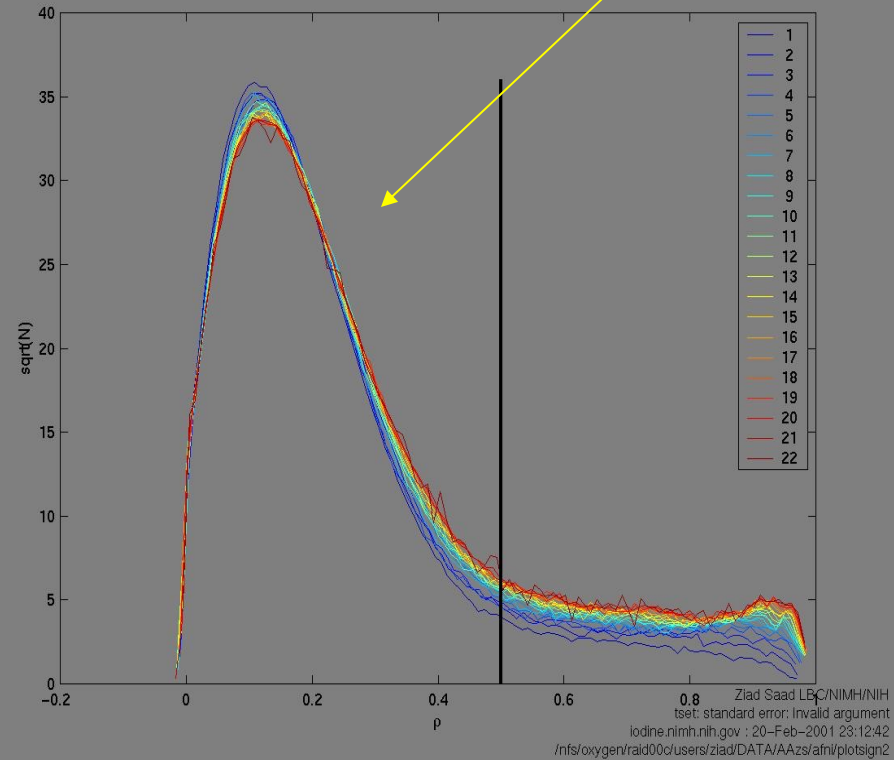

Ziad Saad, et al (Submitted)

Refinements

BOLD Contrast Interpretation

Dynamics

Paradigm Design and Processing

MRI Signal

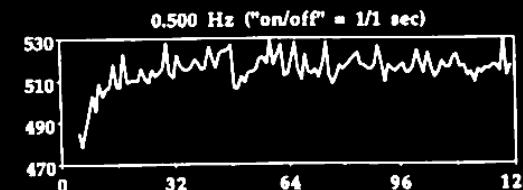
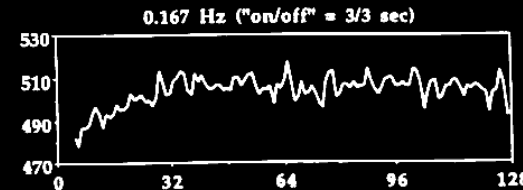
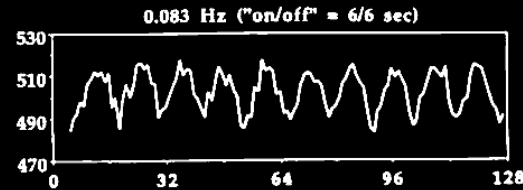
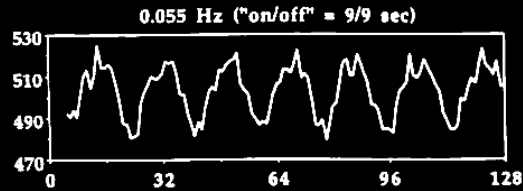
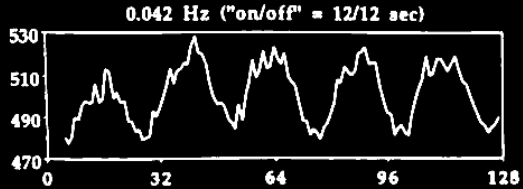
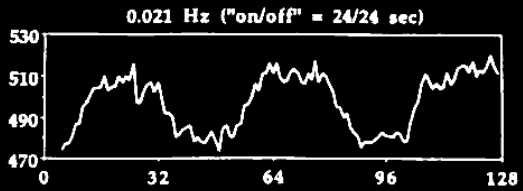

Time (seconds)

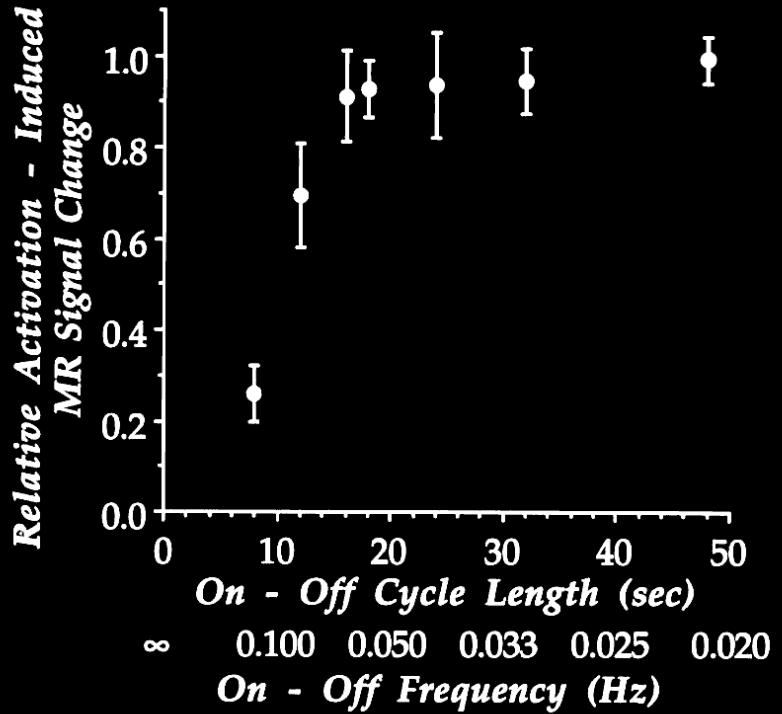

P. A. Bandettini, Functional MRI temporal resolution in "Functional MRI" (C. Moonen, and P. Bandettini., Eds.), p. 205-220, Springer - Verlag, 1999.

BOLD

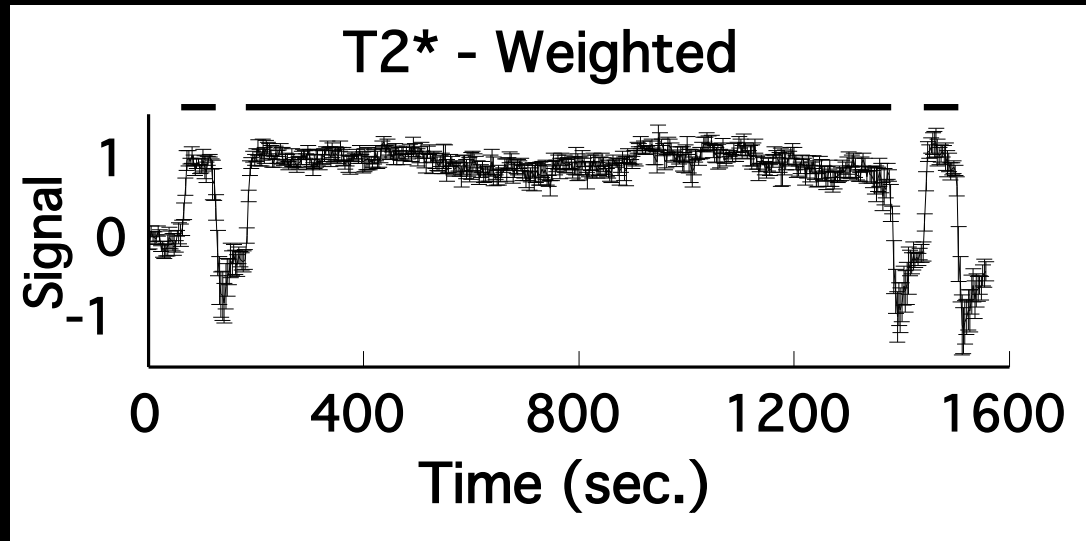

Flow

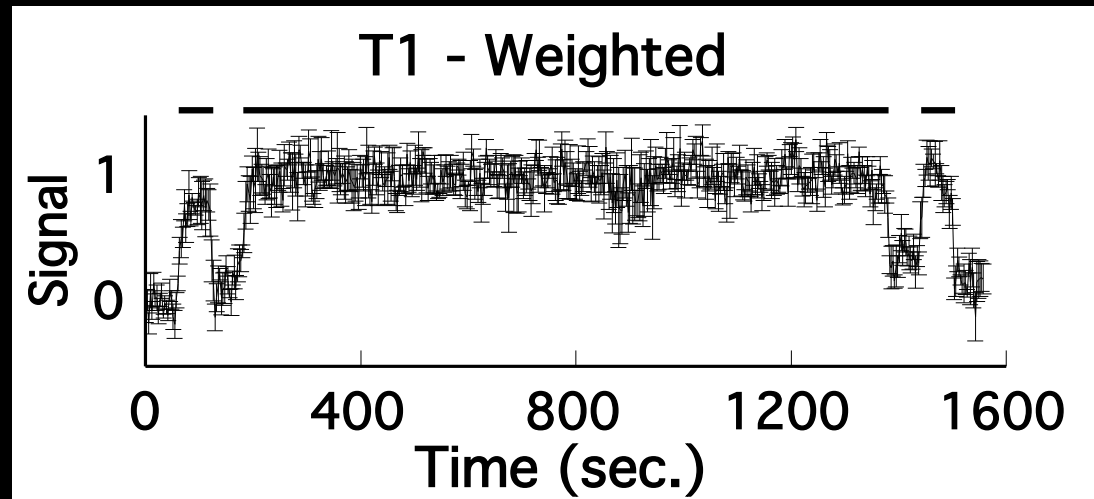

P. A. Bandettini, K. K. Kwong, T. L. Davis, R. B. H. Tootell, E. C. Wong, P. T. Fox, J. W. Belliveau, R. M. Weisskoff, B. R. Rosen, (1997). "Characterization of cerebral blood oxygenation and flow changes during prolonged brain activation." *Human Brain Mapping* 5, 93-109.

Motor Cortex

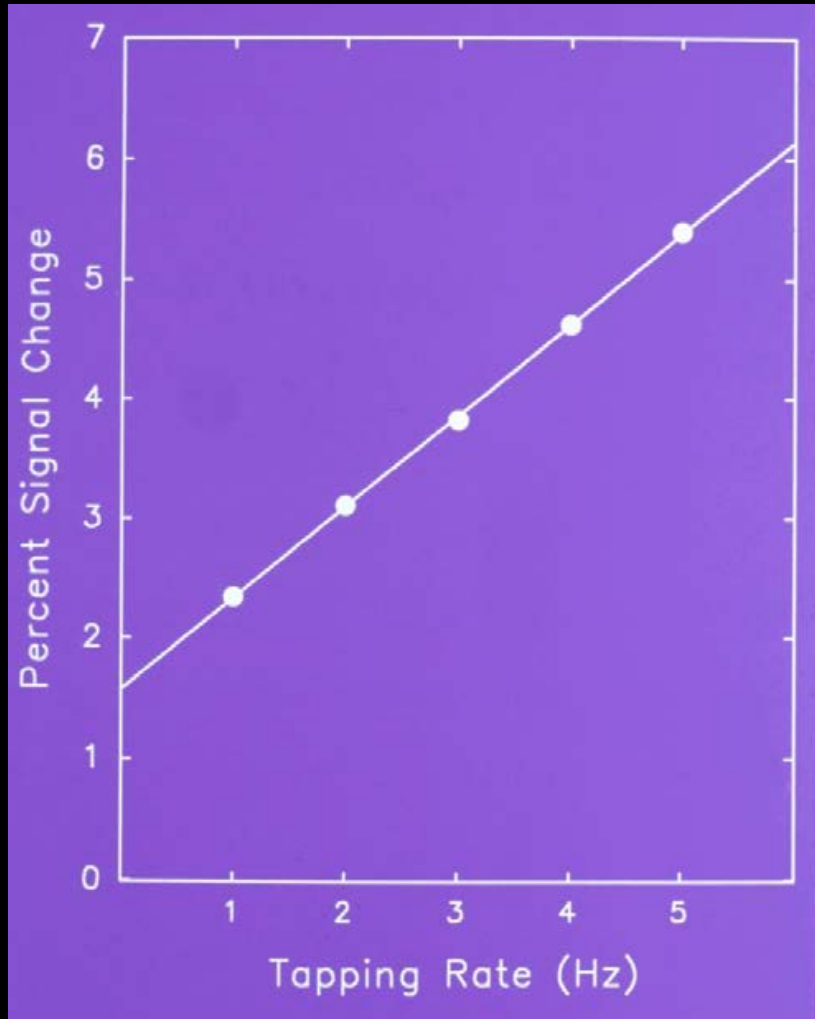

S. M. Rao et al, (1996) "Relationship between finger movement rate and functional magnetic resonance signal change in human primary motor cortex." *J. Cereb. Blood Flow and Met.* 16, 1250-1254.

Auditory Cortex

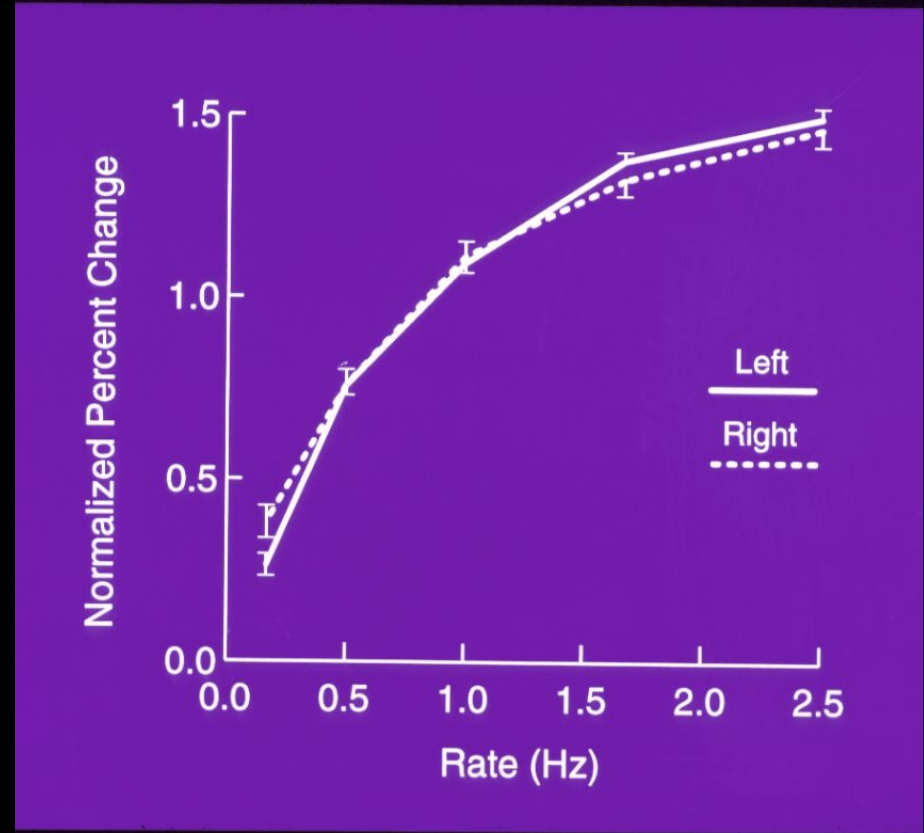

J. R. Binder, et al, (1994). "Effects of stimulus rate on signal response during functional magnetic resonance imaging of auditory cortex." *Cogn. Brain Res.* 2, 31-38

Logothetis et al. (2001) "Neurophysiological investigation of the basis of the fMRI signal" *Nature*, 412, 150-157

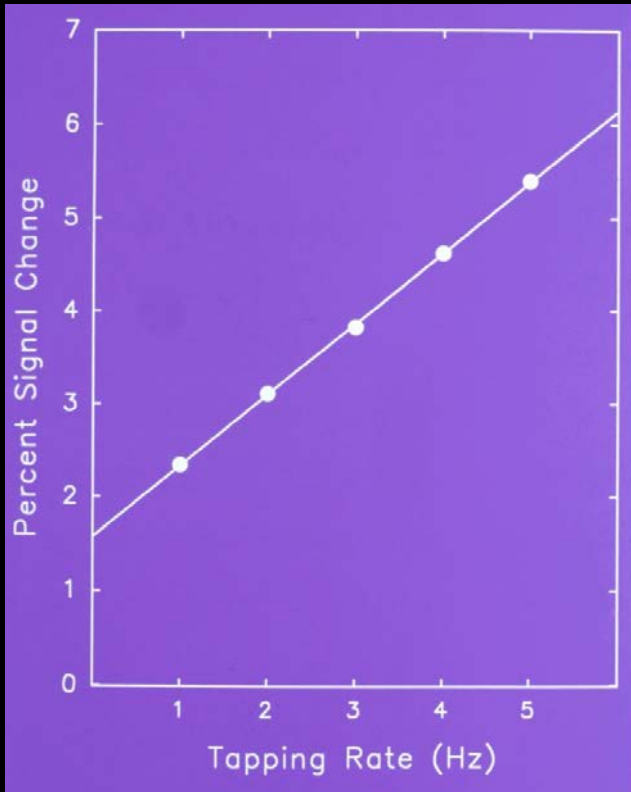

S. M. Rao et al, (1996) "Relationship between finger movement rate and functional magnetic resonance signal change in human primary motor cortex." *J. Cereb. Blood Flow and Met.* 16, 1250-1254.

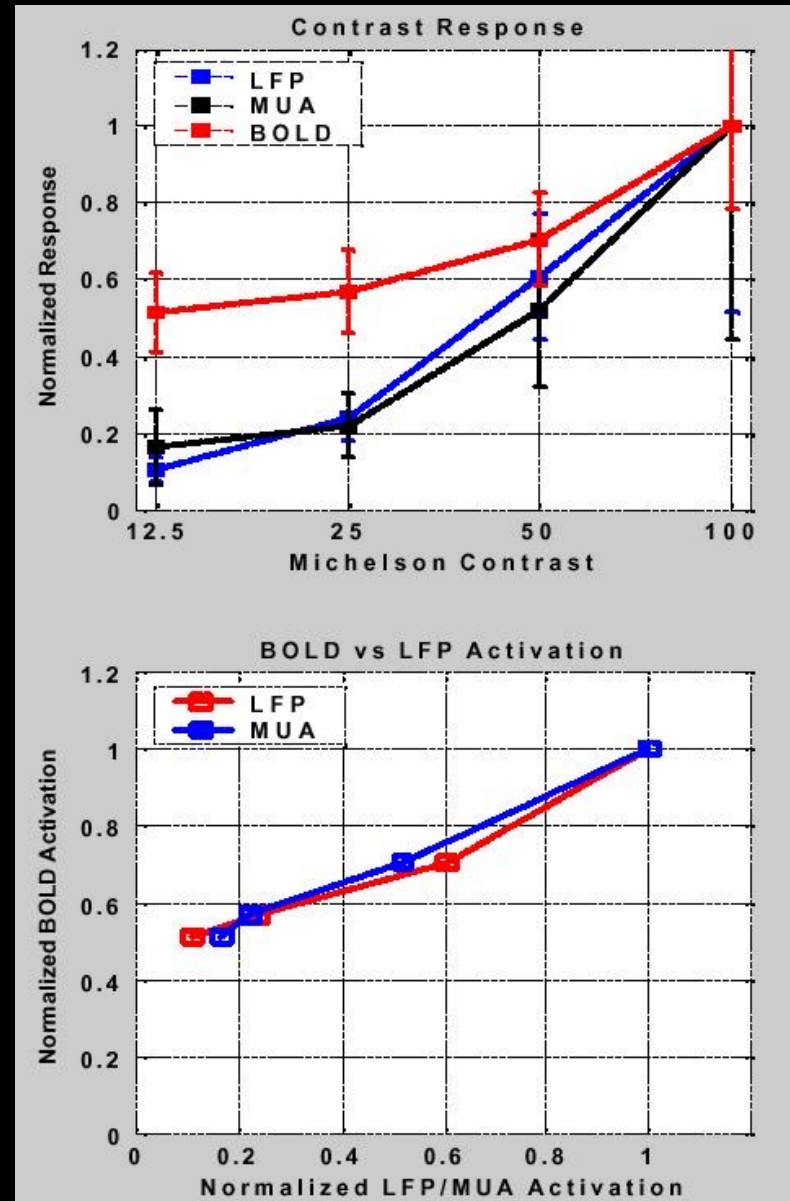

First Event-related fMRI Results

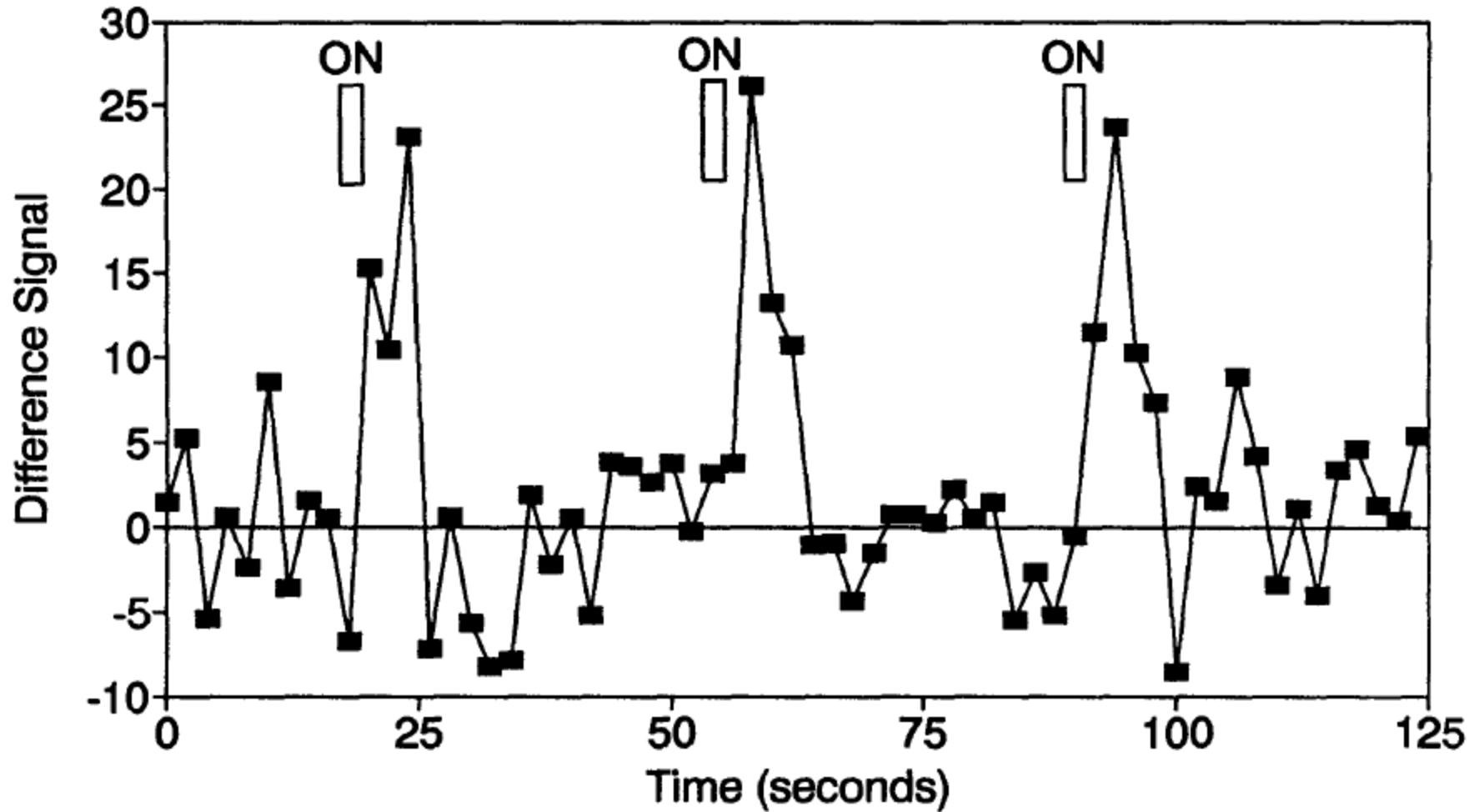

Blamire, A. M., et al. (1992). "Dynamic mapping of the human visual cortex by high-speed magnetic resonance imaging." *Proc. Natl. Acad. Sci. USA* 89: 11069-11073.

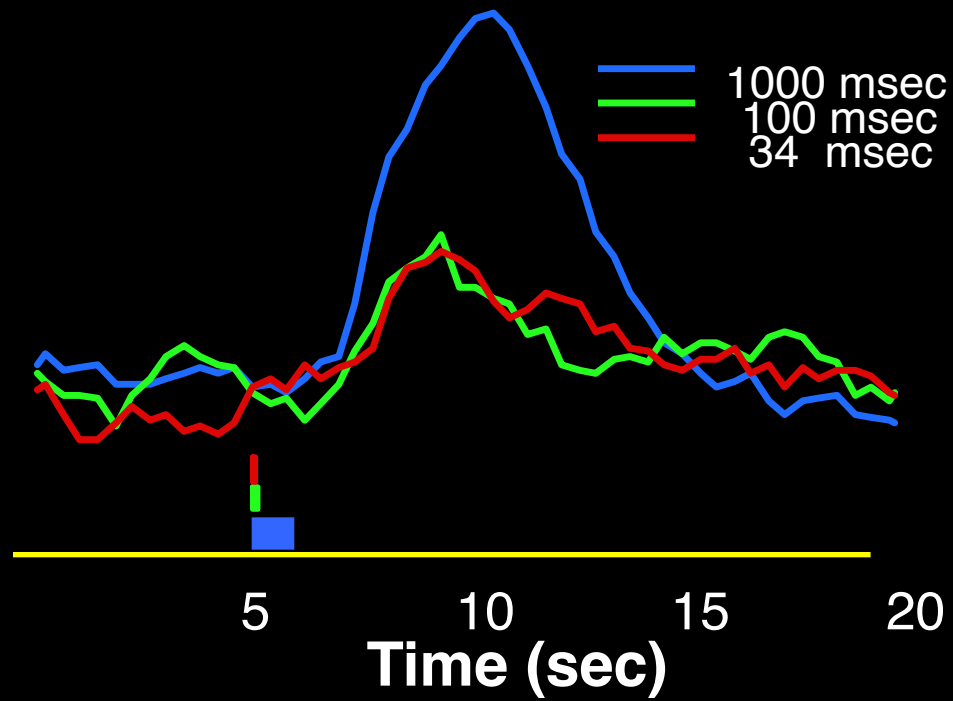

R. L. Savoy, et al., Pushing the temporal resolution of fMRI: studies of very brief visual stimuli, onset variability and asynchrony, and stimulus-correlated changes in noise [oral], 3rd Proc. Soc. Magn. Reson., Nice, p. 450. (1995).

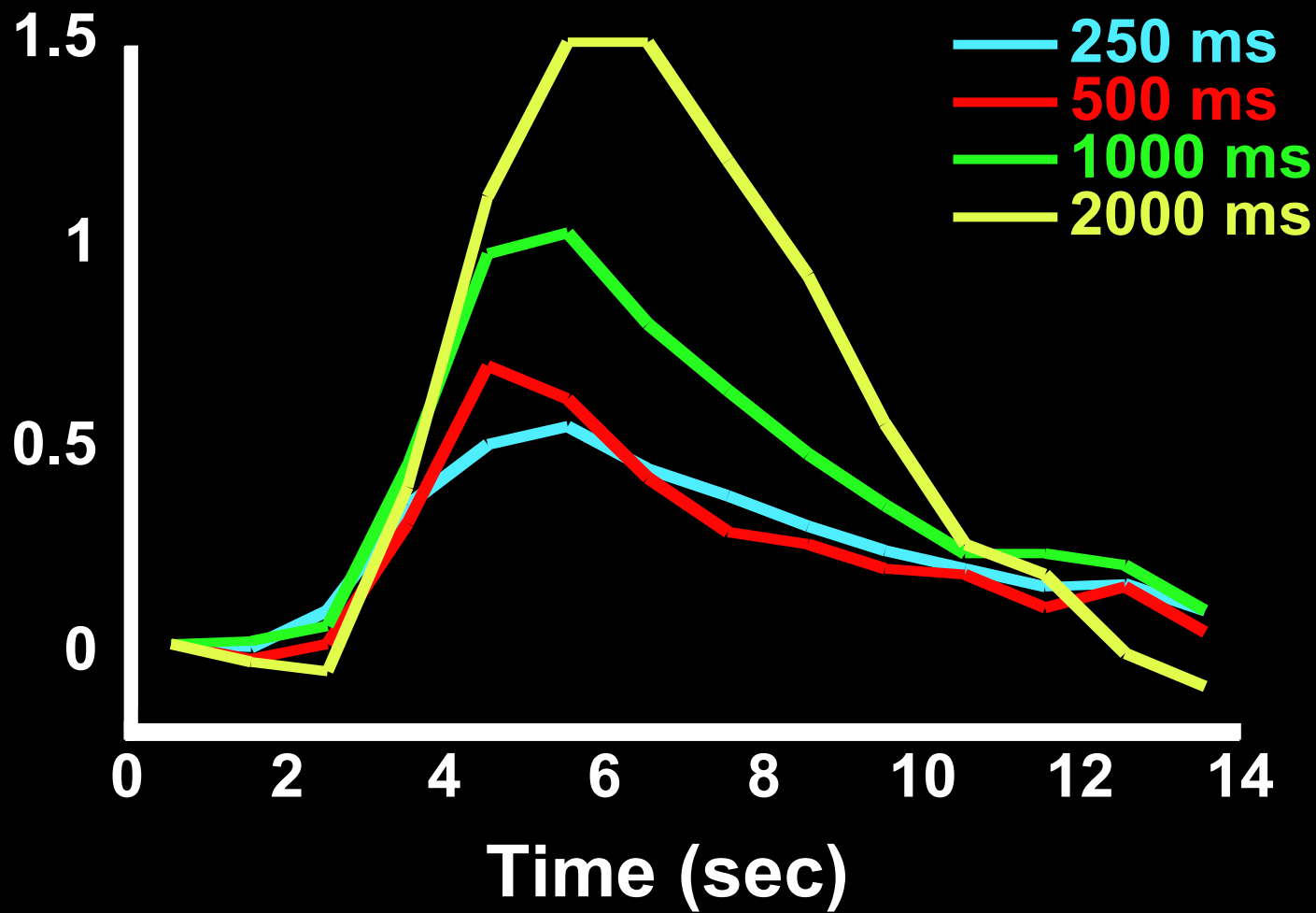

Methods

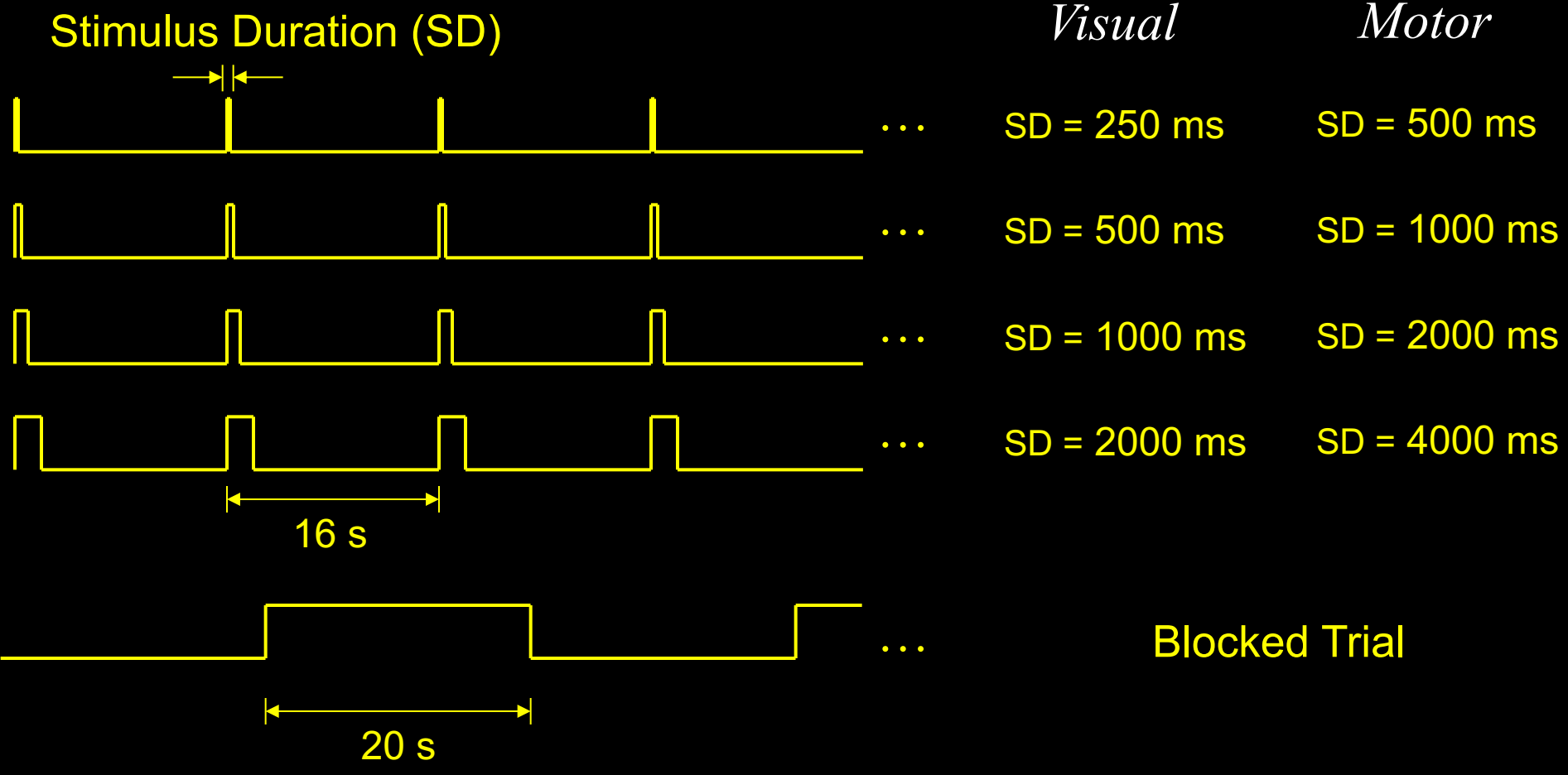

Dynamic Nonlinearity Assessment

Different stimulus “ON” periods

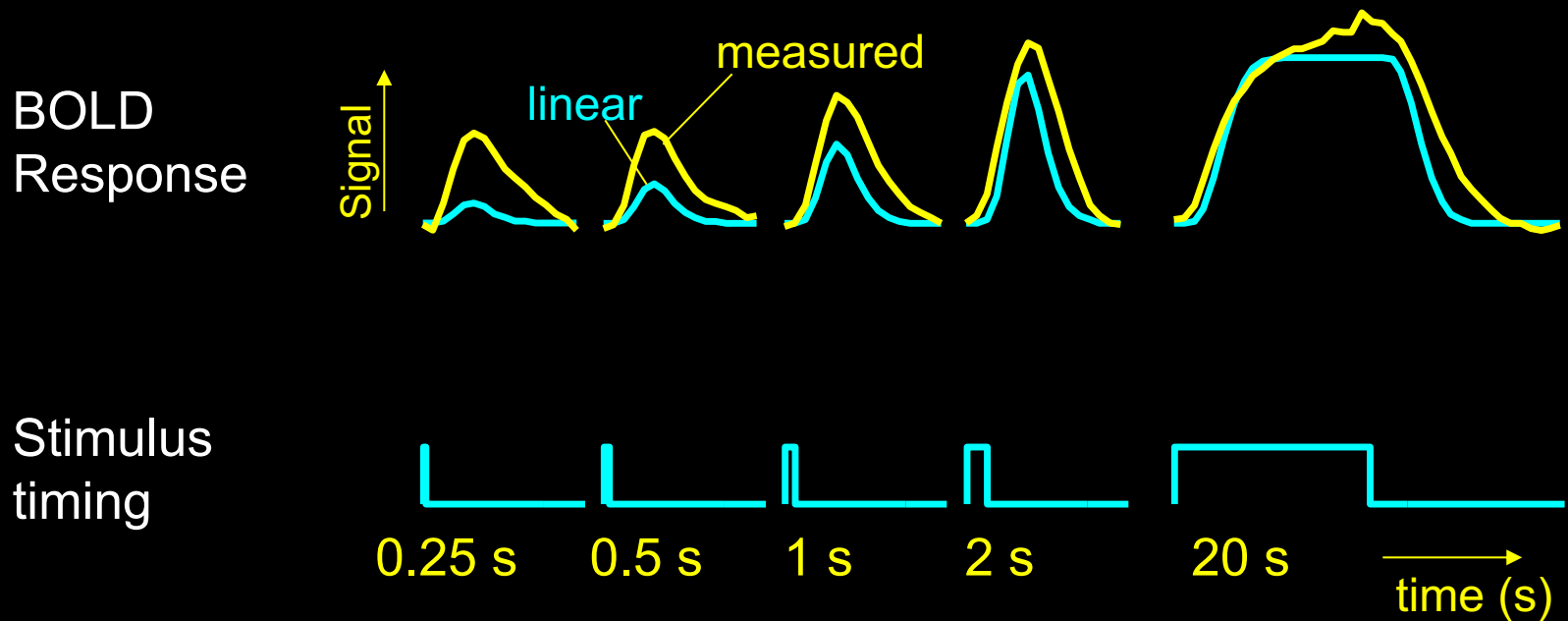

Brief stimuli produce larger responses than expected

BOLD response is nonlinear

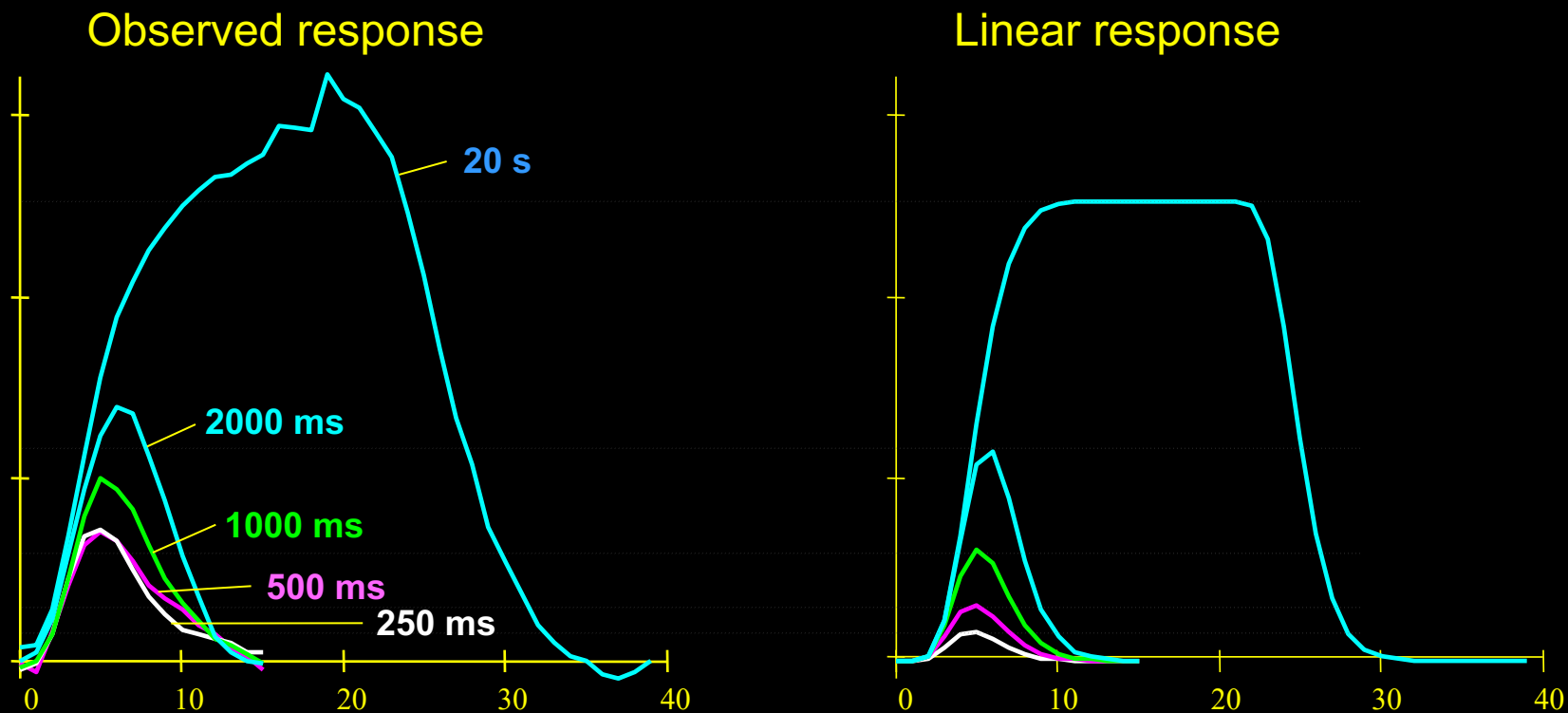

Short duration stimuli produce larger responses than expected

Spatial Heterogeneity of BOLD Nonlinearity

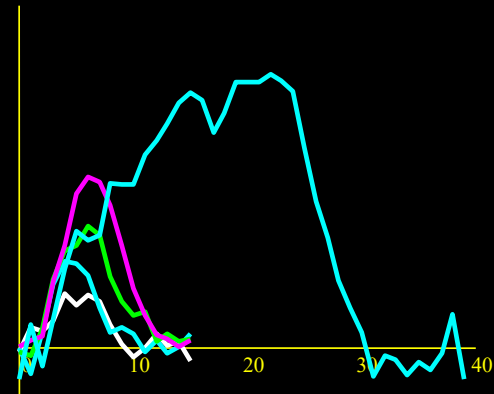
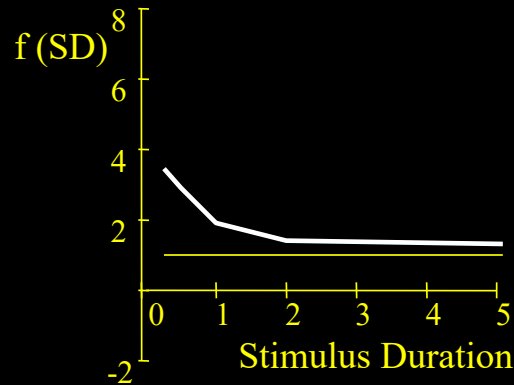
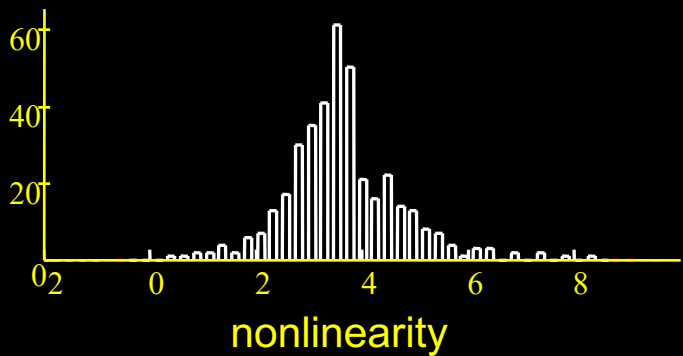
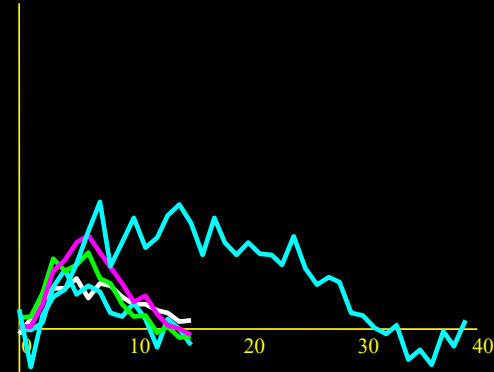
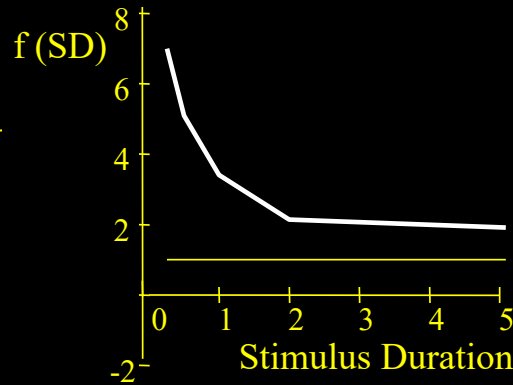
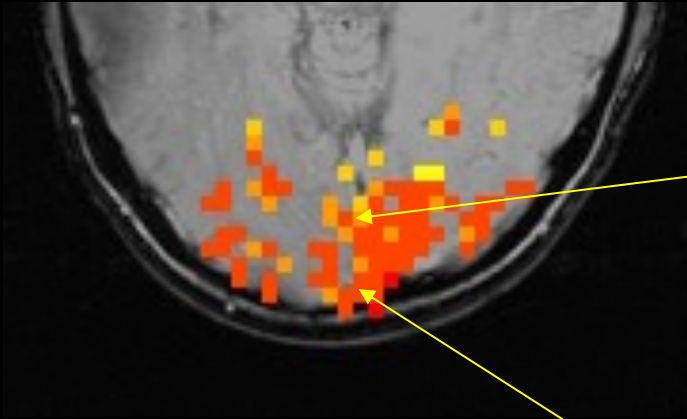

R. M. Birn, Z. Saad, P. A. Bandettini, (2001) "Spatial heterogeneity of the nonlinear dynamics in the fMRI BOLD response." *NeuroImage*, 14: 817-826.

Results – visual task

Nonlinearity

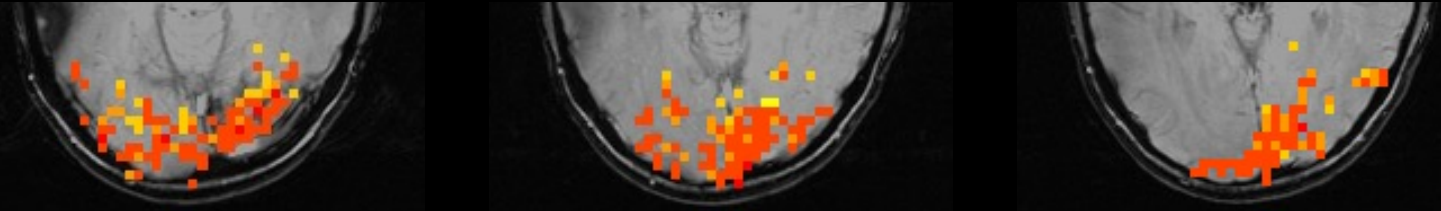

Magnitude

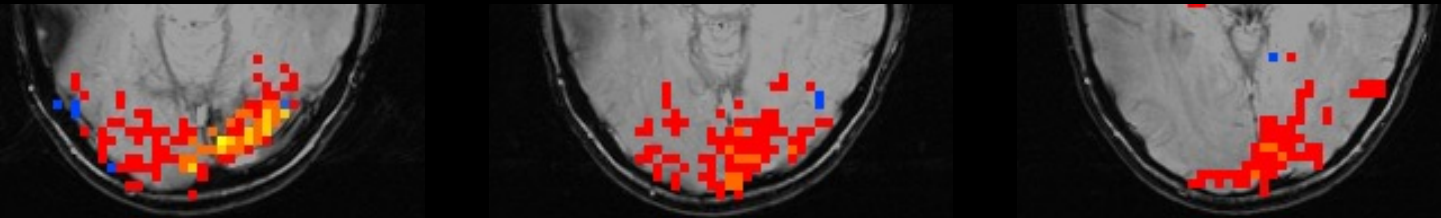

Latency

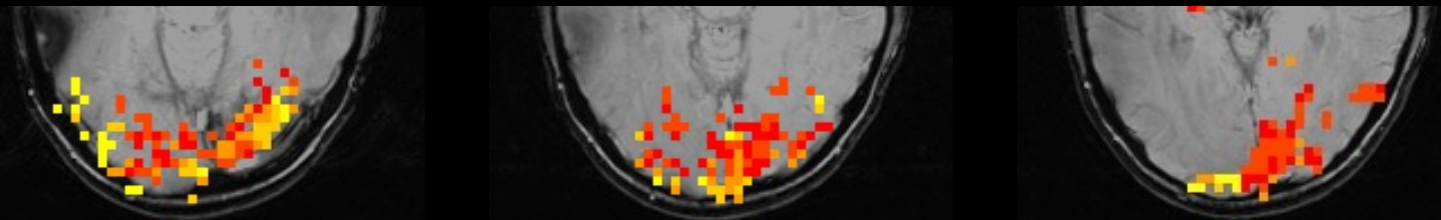

Results — motor task

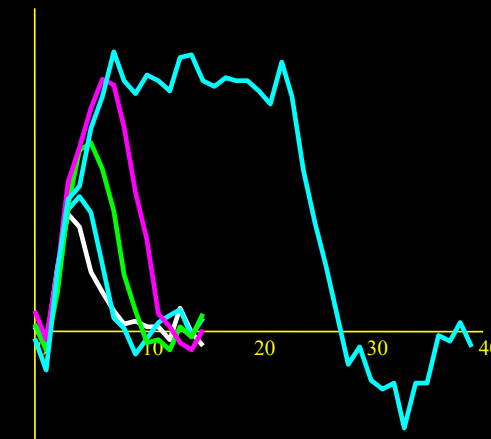
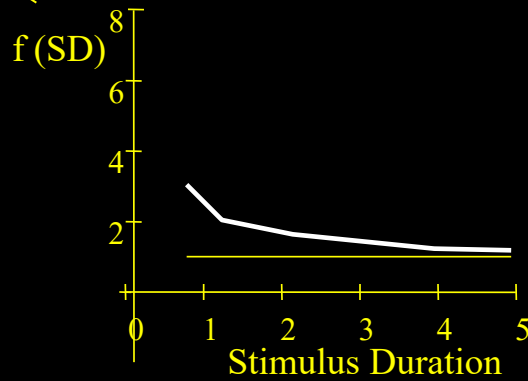
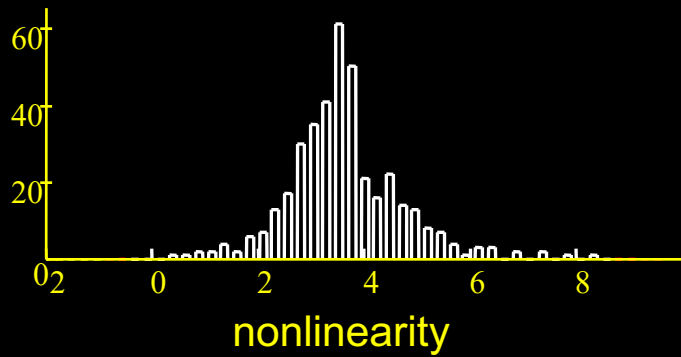
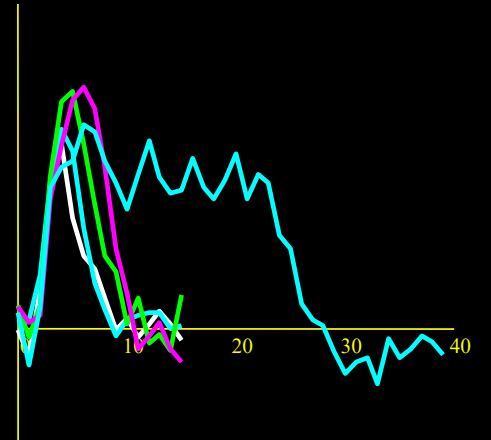
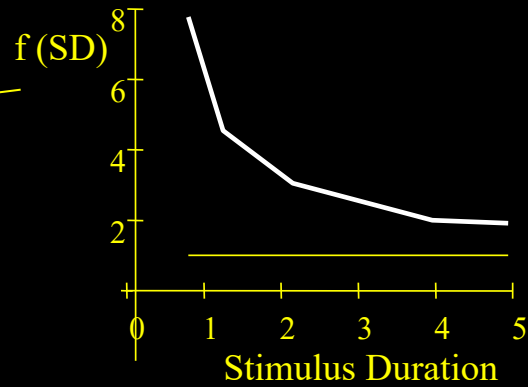
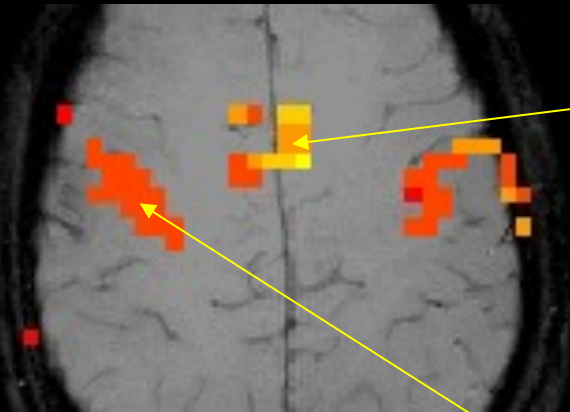

Results — motor task

Nonlinearity

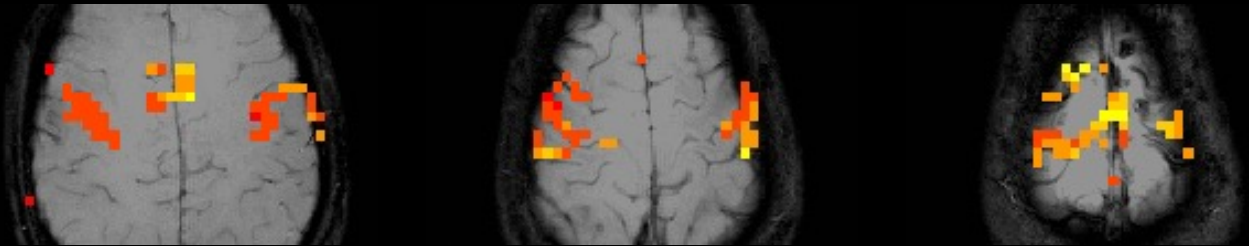

Magnitude

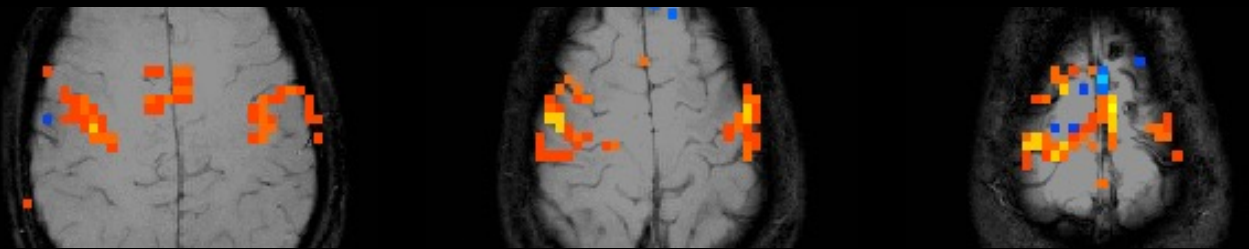

Latency

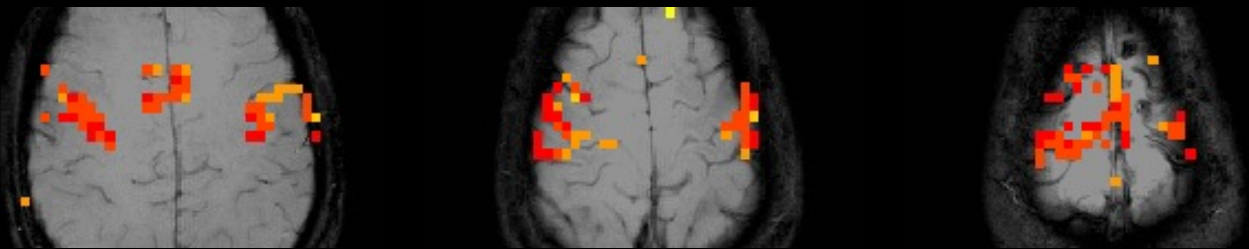

Reproducibility

Visual task

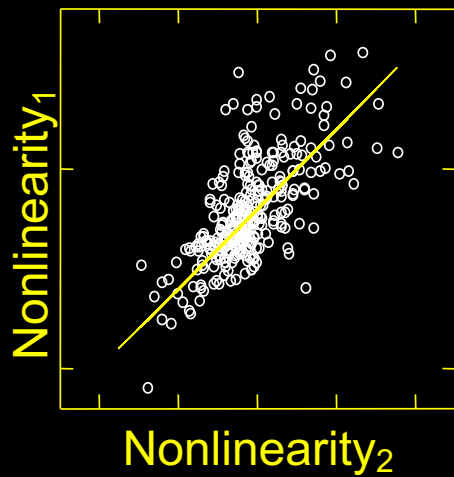

Motor task

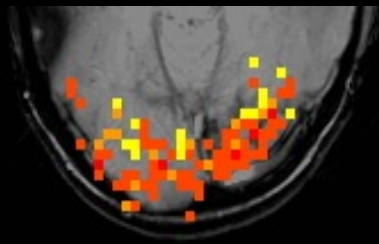
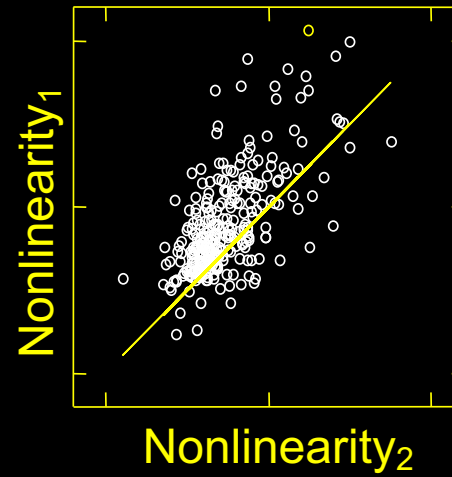

Experiment 1

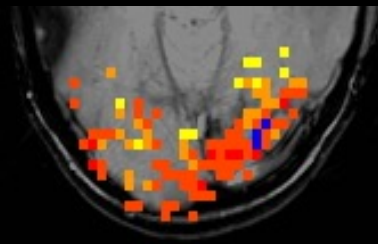

Experiment 2

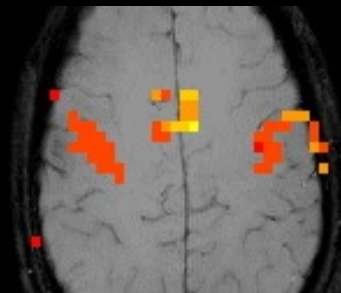

Experiment 1

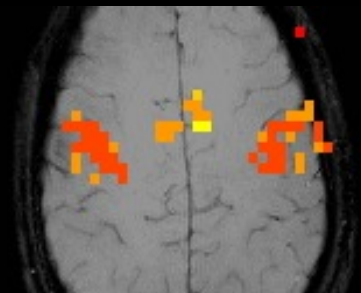

Experiment 2

Different stimulus “ON” periods

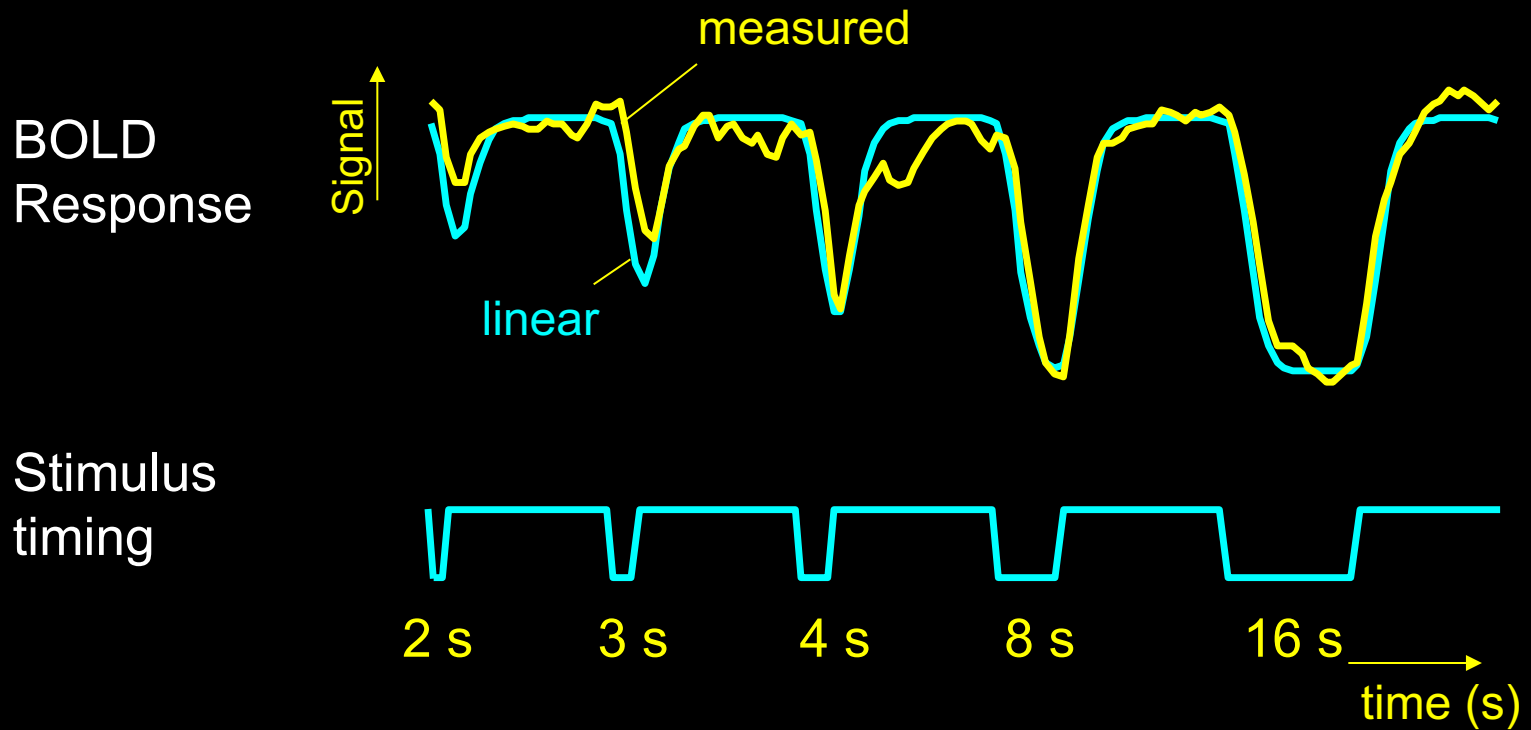

Brief stimulus OFF periods produce smaller decreases than expected

Sources of this Nonlinearity

- Neuronal

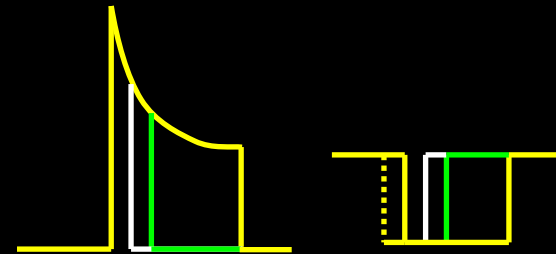
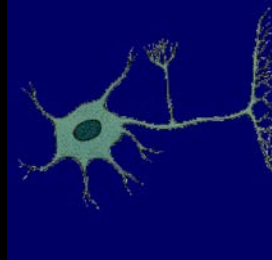

- Hemodynamic

- Oxygen extraction
- Blood volume dynamics

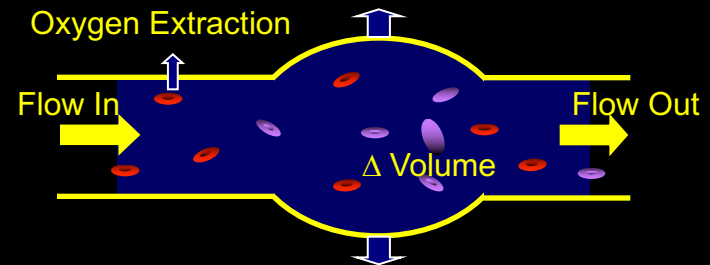

BOLD Correlation with Neuronal Activity

Logothetis et al. (2001)
“Neurophysiological investigation
of the basis of the fMRI signal”
Nature, 412, 150-157.

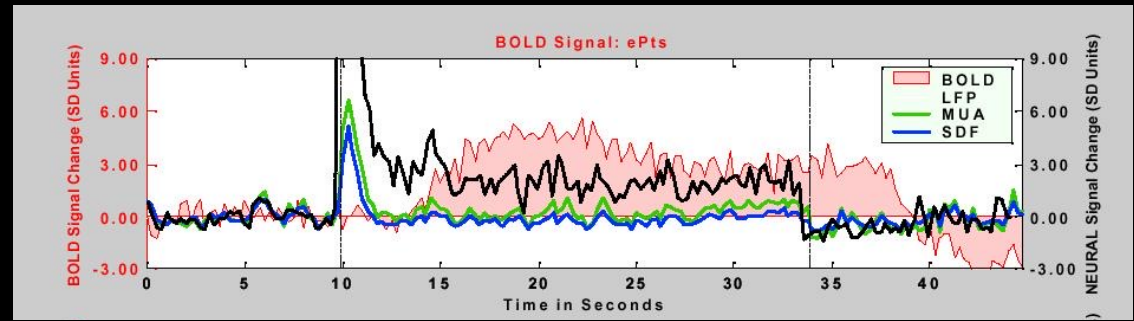

P. A. Bandettini and L. G. Ungerleider, (2001) “From neuron
to BOLD: new connections.”
Nature Neuroscience, 4: 864-866.

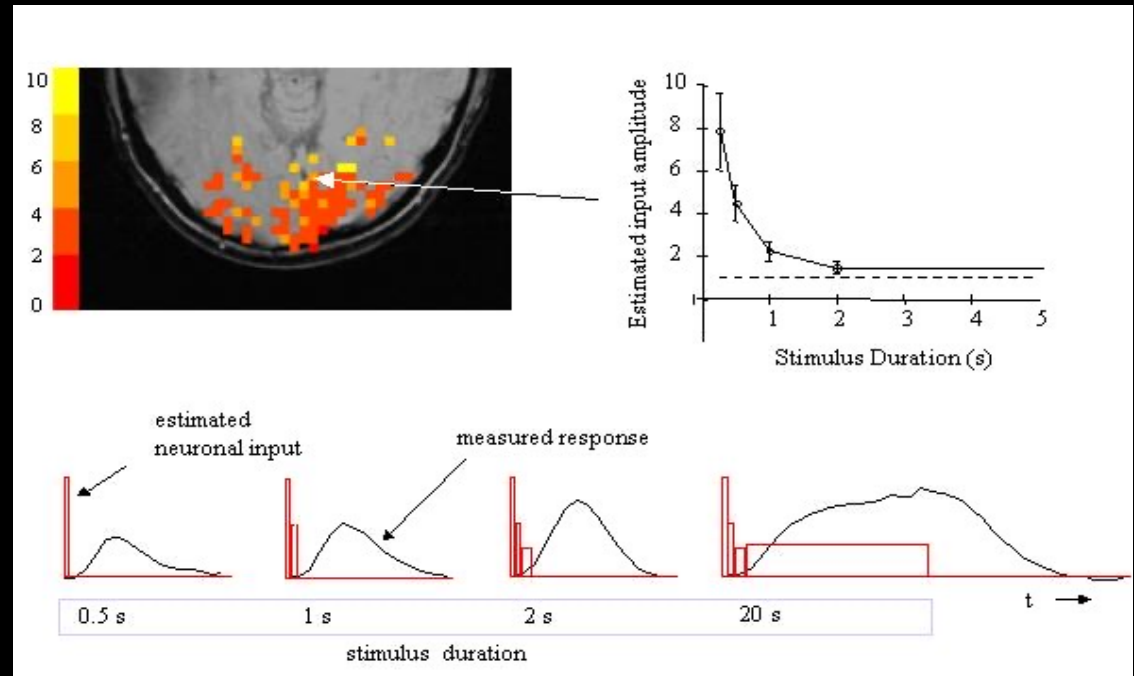

Stationary grating

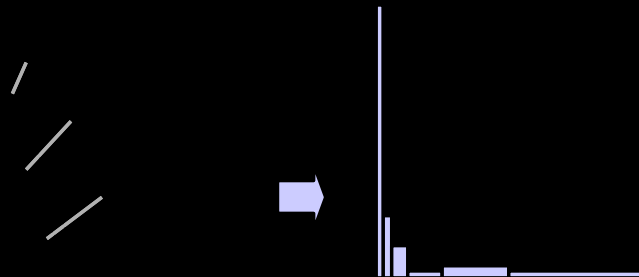

Contrast-reversing checkerboard

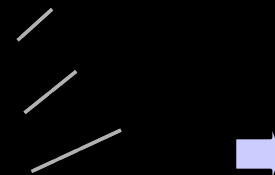

Refinements

BOLD Contrast Interpretation

Dynamics

Paradigm Design and Processing





Neuronal Activation Input Strategies

1. Block Design

2. Parametric Design

3. Frequency Encoding

4. Phase Encoding

5. Event Related

6. Orthogonal Design

7. Free Behavior Design

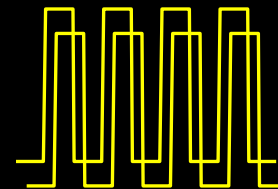
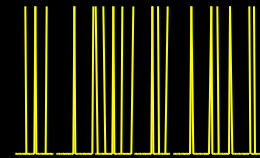
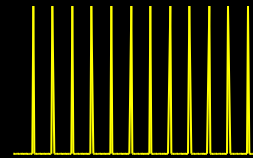
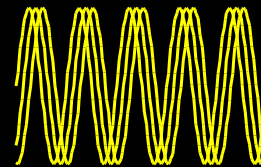
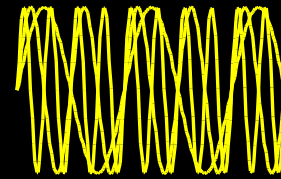
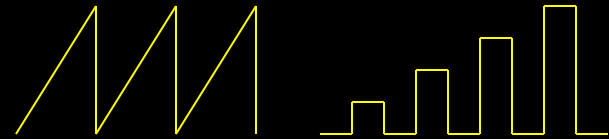

Neuronal Activation Input Strategies

1. Block Design

2. Parametric Design

3. Frequency Encoding

4. Phase Encoding

5. Event Related

6. Orthogonal Design

7. Free Behavior Design

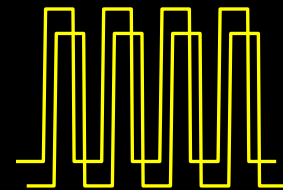
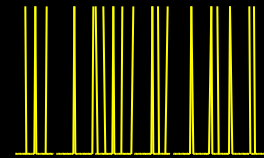
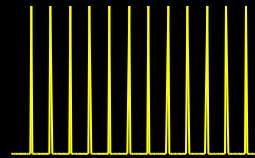
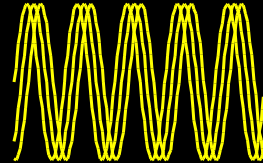
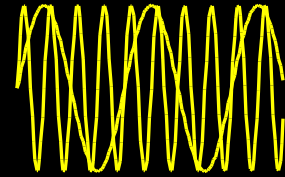
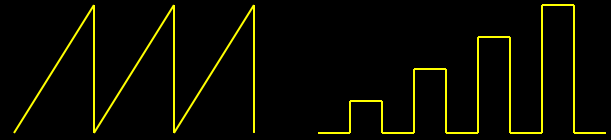

Both the Task and Presentation Rate Affect the fMRI Response

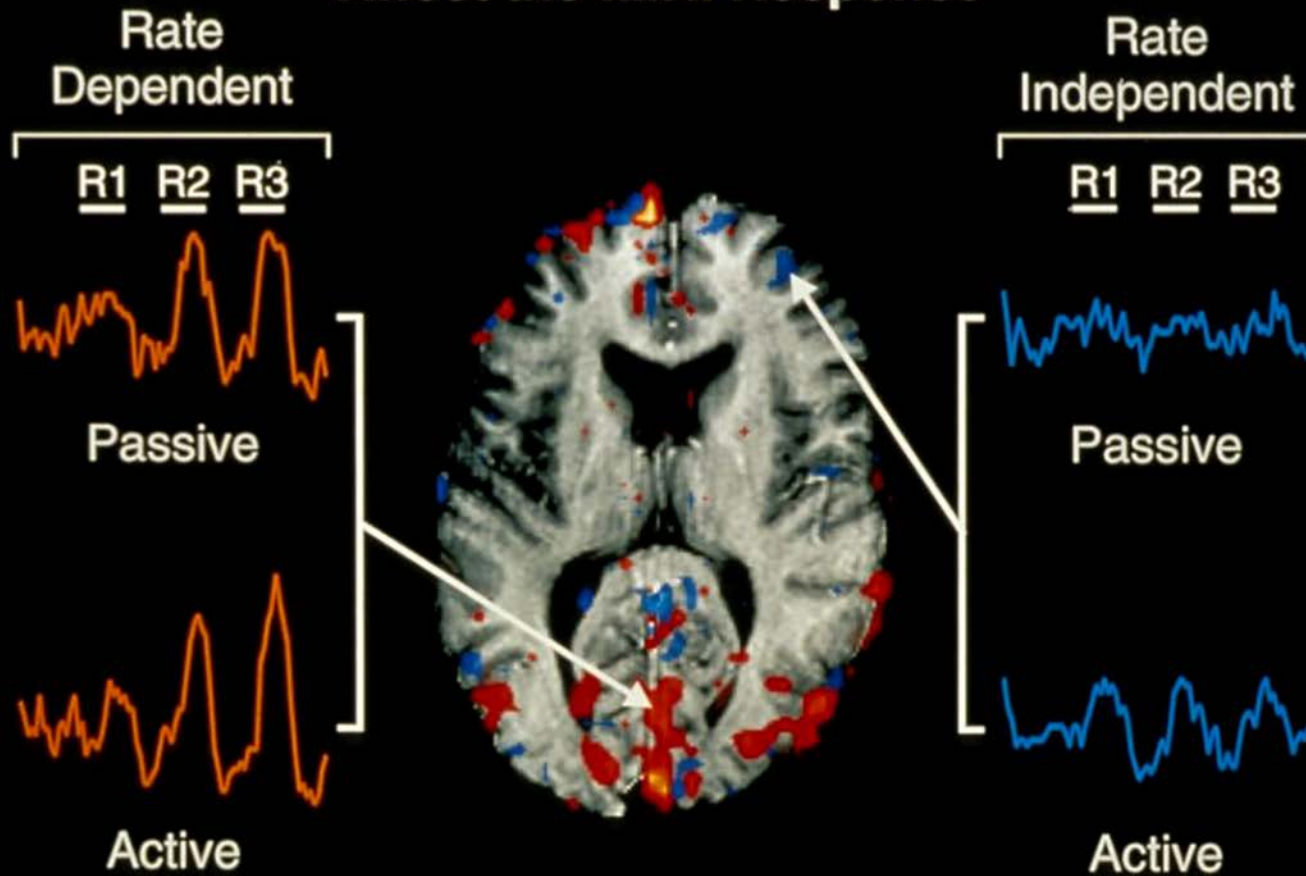

E. A. DeYoe, P. A. Bandettini, J. Nietz, D. Miller, P. Winas, Methods for functional magnetic resonance imaging (fMRI). *J. Neuroscience Methods* 54, 171-187 (1994).

Neuronal Activation Input Strategies

1. Block Design

2. Parametric Design

3. Frequency Encoding

4. Phase Encoding

5. Event Related

6. Orthogonal Design

7. Free Behavior Design

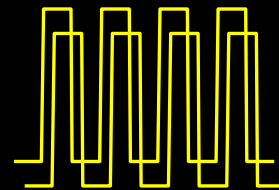
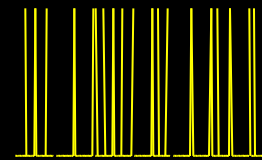
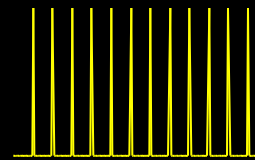
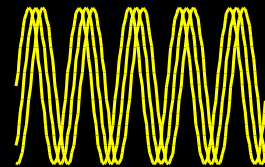
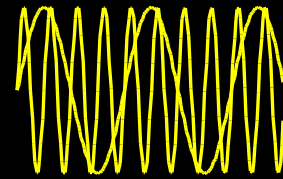
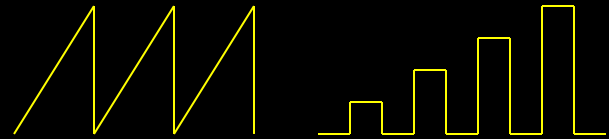

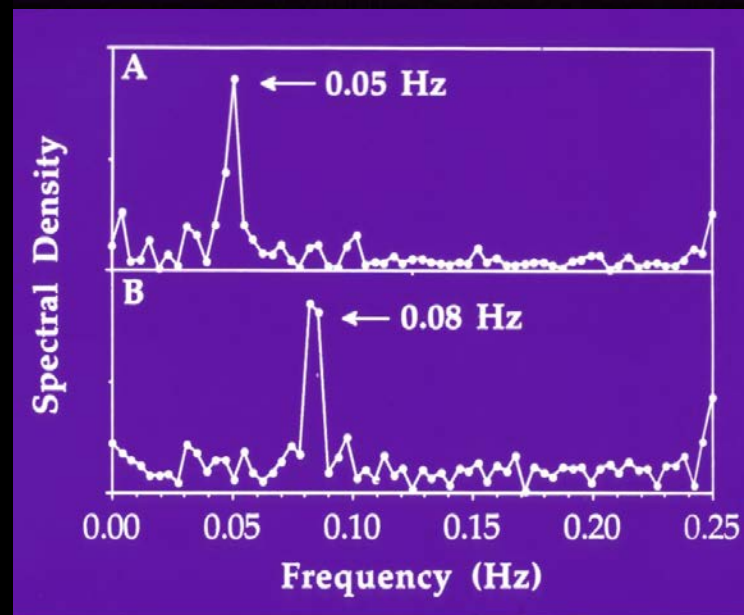
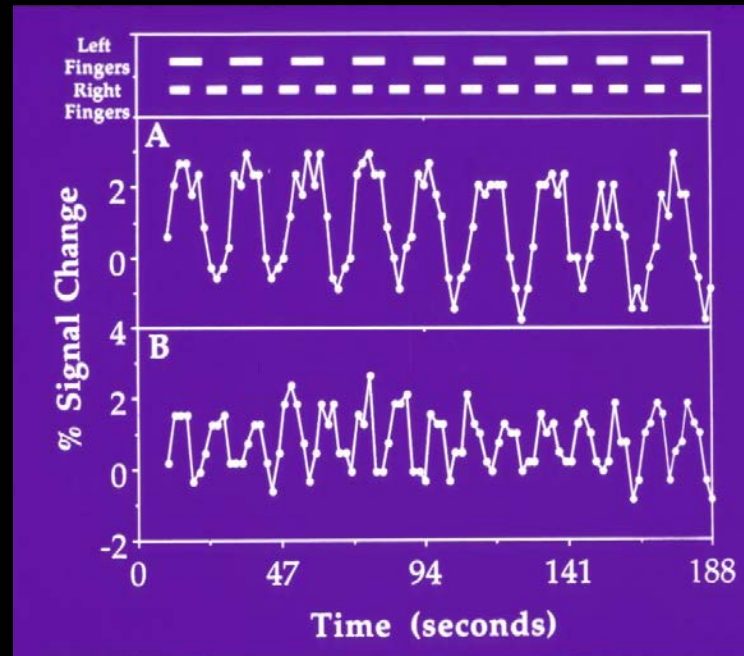
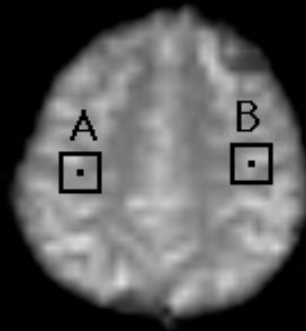

P. A. Bandettini, A. Jesmanowicz, E. C. Wong, J. S. Hyde, Processing strategies for time-course data sets in functional MRI of the human brain. *Magn. Reson. Med.* 30, 161-173 (1993).

0.08 Hz

0.05 Hz

**spectral
density**

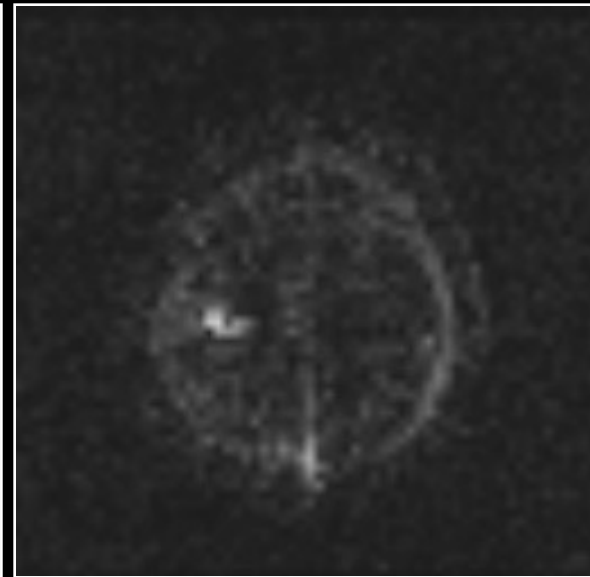
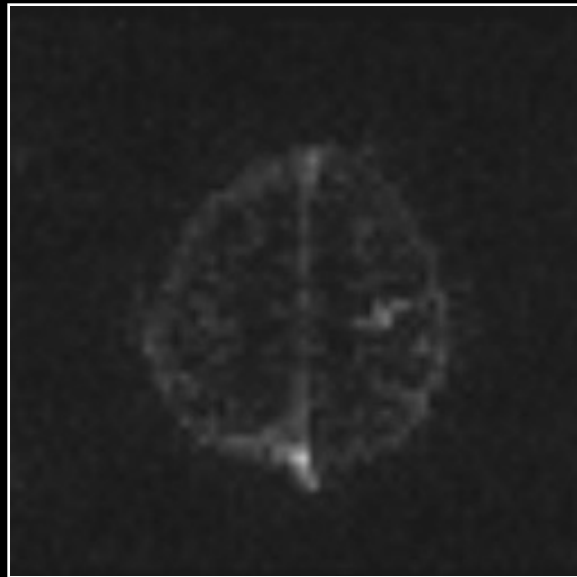

**c.c. > 0.5
with spectra**

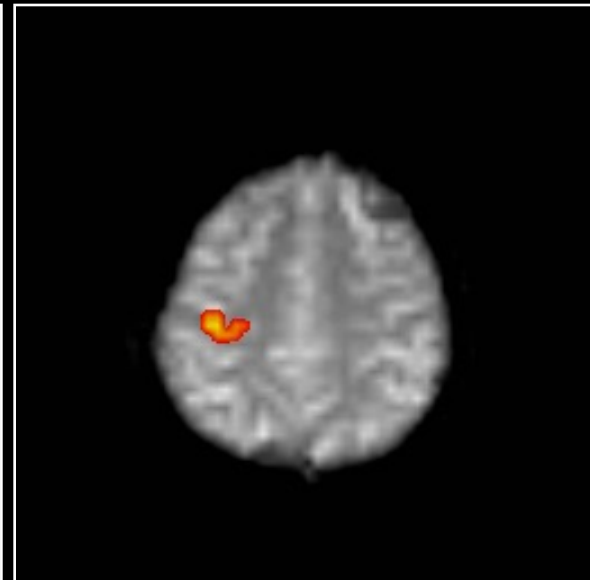
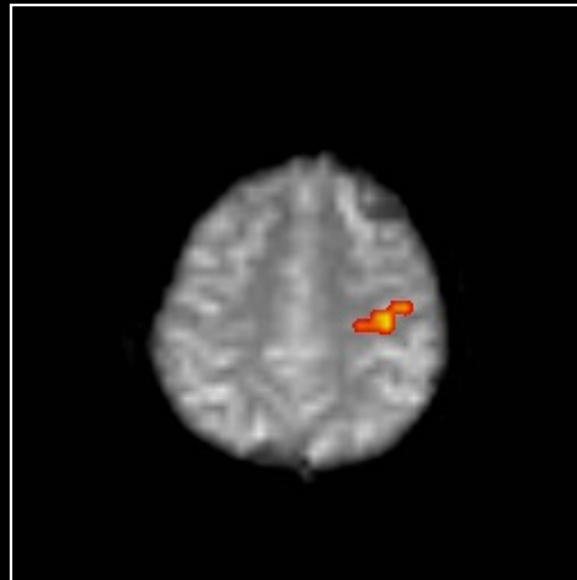

P. A. Bandettini, A. Jesmanowicz, E. C. Wong, J. S. Hyde, Processing strategies for time-course data sets in functional MRI of the human brain. *Magn. Reson. Med.* 30, 161-173 (1993).

Neuronal Activation Input Strategies

1. Block Design

2. Parametric Design

3. Frequency Encoding

4. Phase Encoding

5. Event Related

6. Orthogonal Design

7. Free Behavior Design

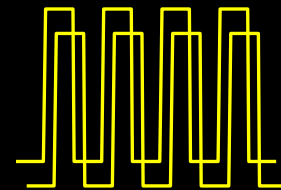
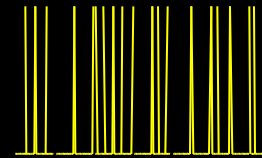
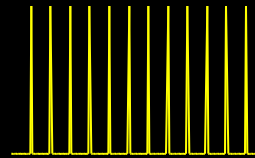
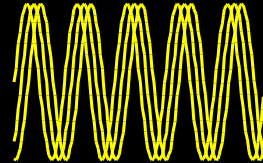
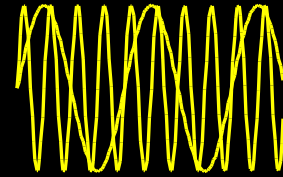
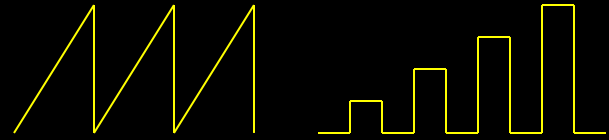

Mapping striate and extrastriate visual areas in human cerebral cortex

EDGAR A. DEYOE*, GEORGE J. CARMAN†, PETER BANDETTINI‡, SETH GLICKMAN*, JON WIESER*, ROBERT COX§, DAVID MILLER¶, AND JAY NEITZ*

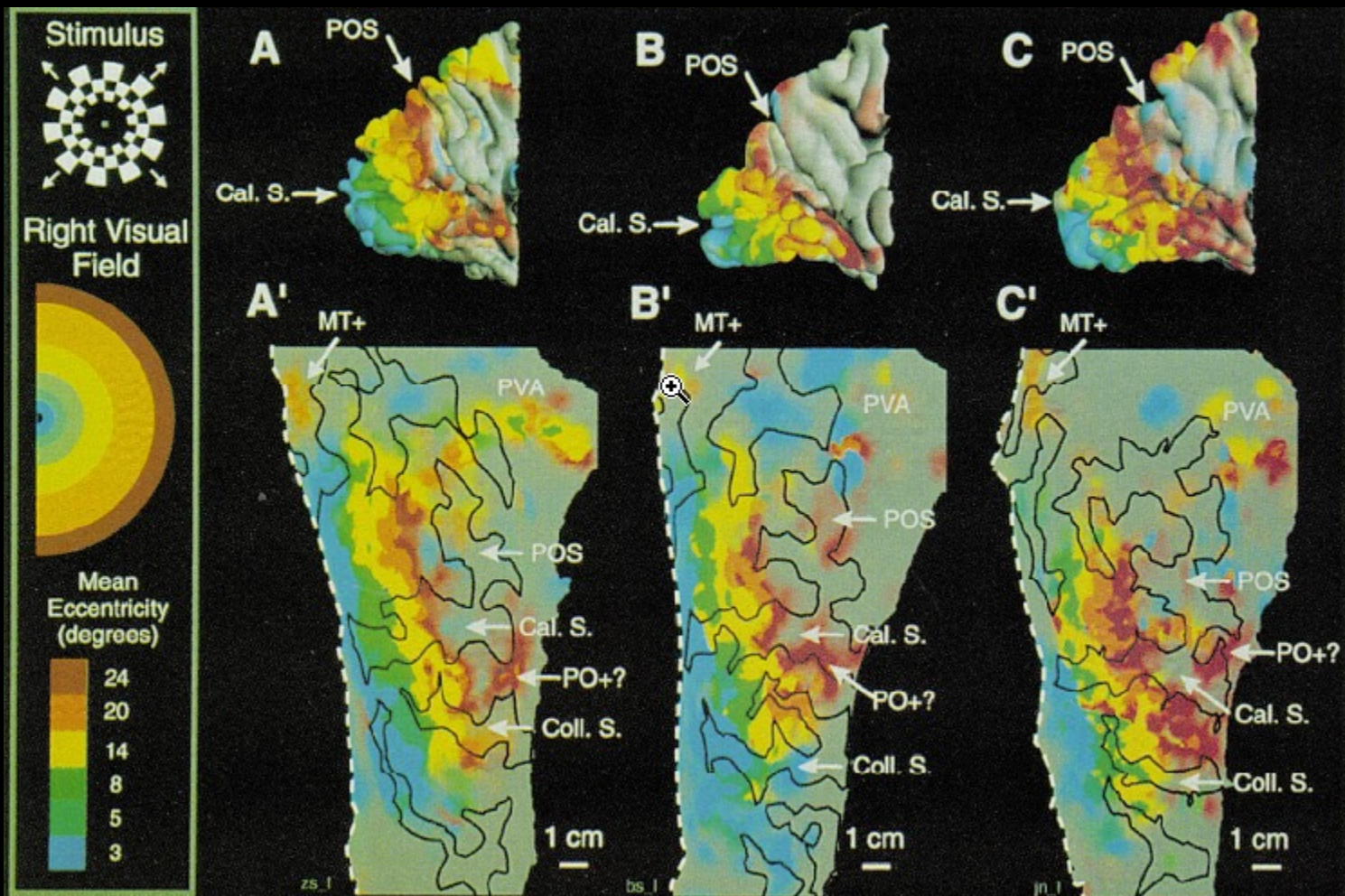

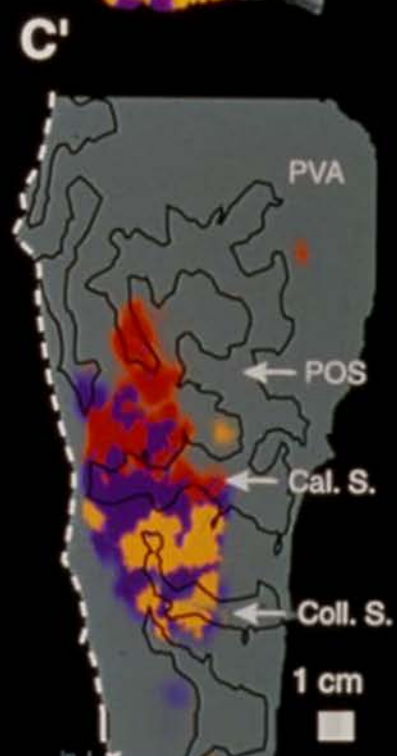
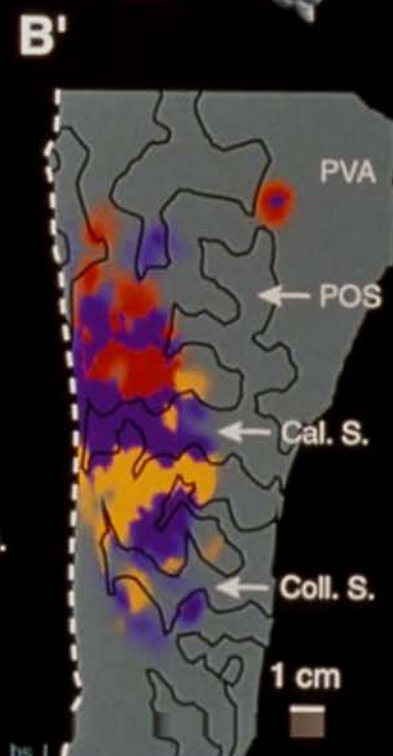
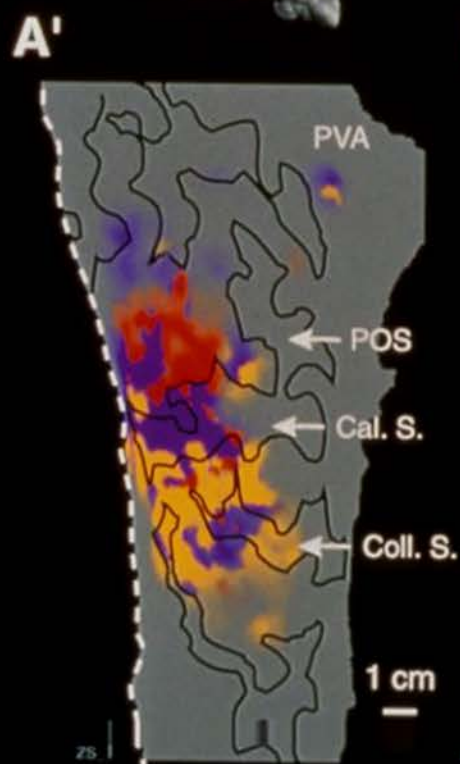
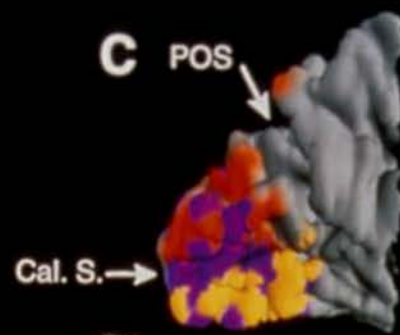
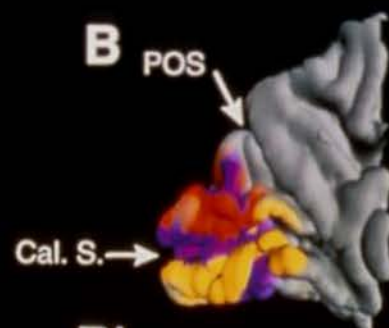
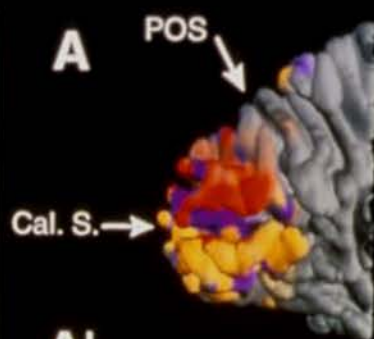
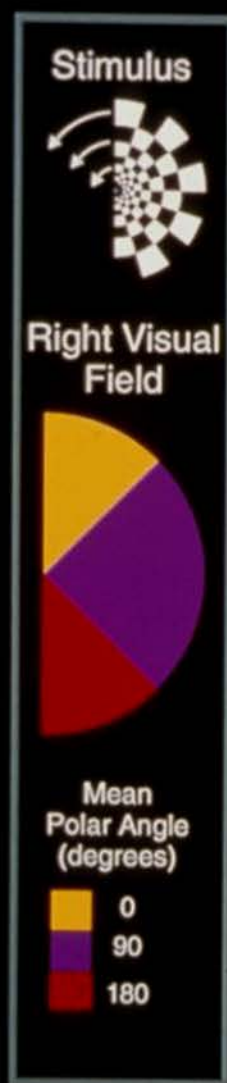

Neuronal Activation Input Strategies

1. Block Design

2. Parametric Design

3. Frequency Encoding

4. Phase Encoding

5. Event Related

6. Orthogonal Design

7. Free Behavior Design

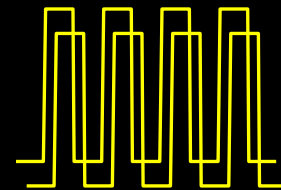
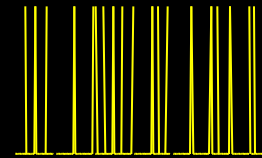
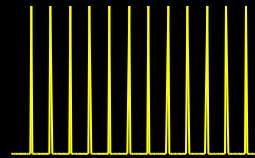
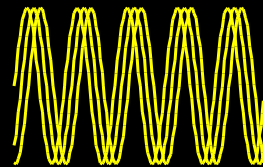
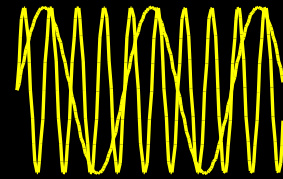
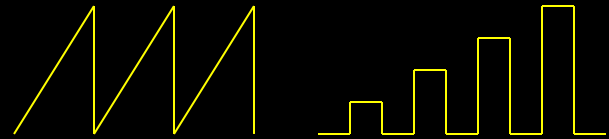

Word stem completion

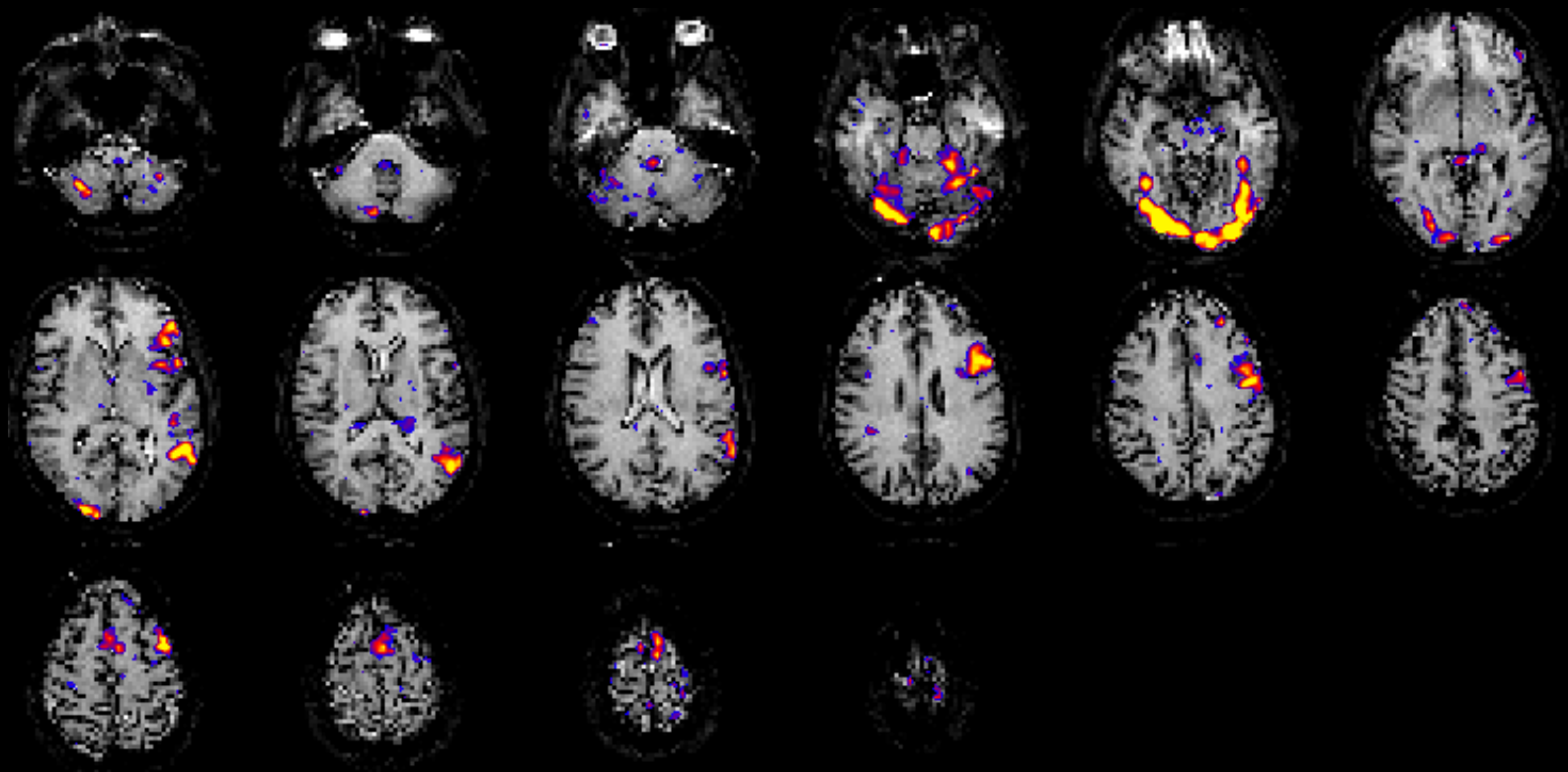

BLOCKED:



SINGLE TRIAL:

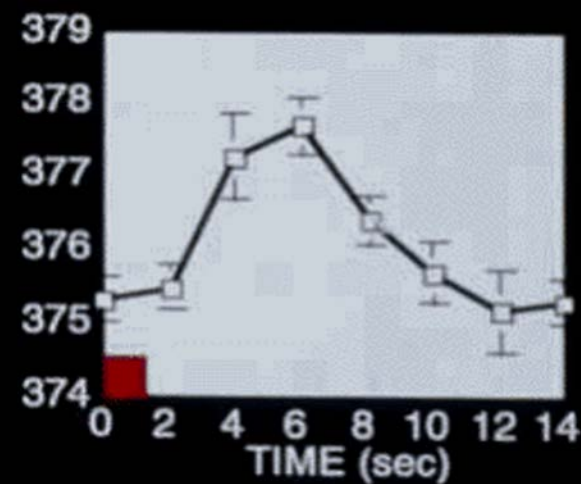
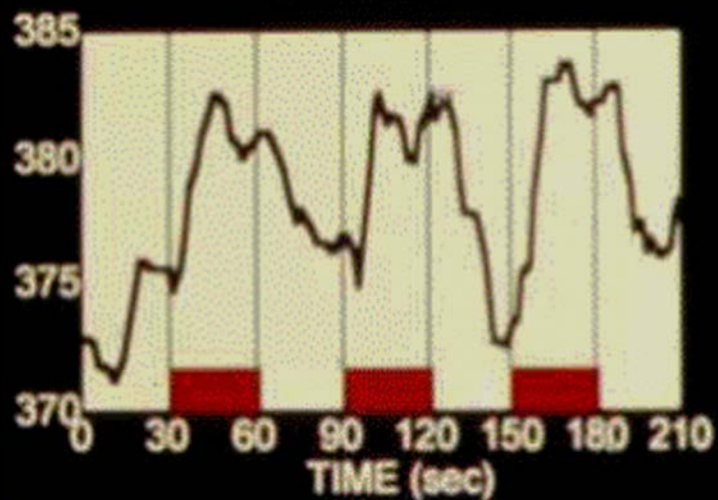
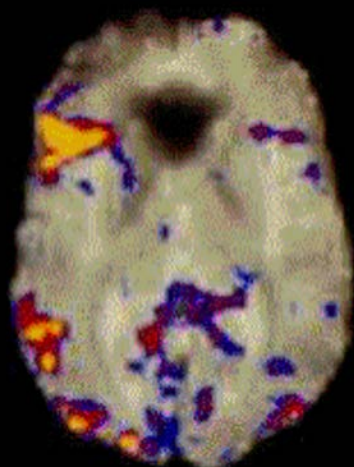

"Single-Trial" Response Across an Averaged Data Set

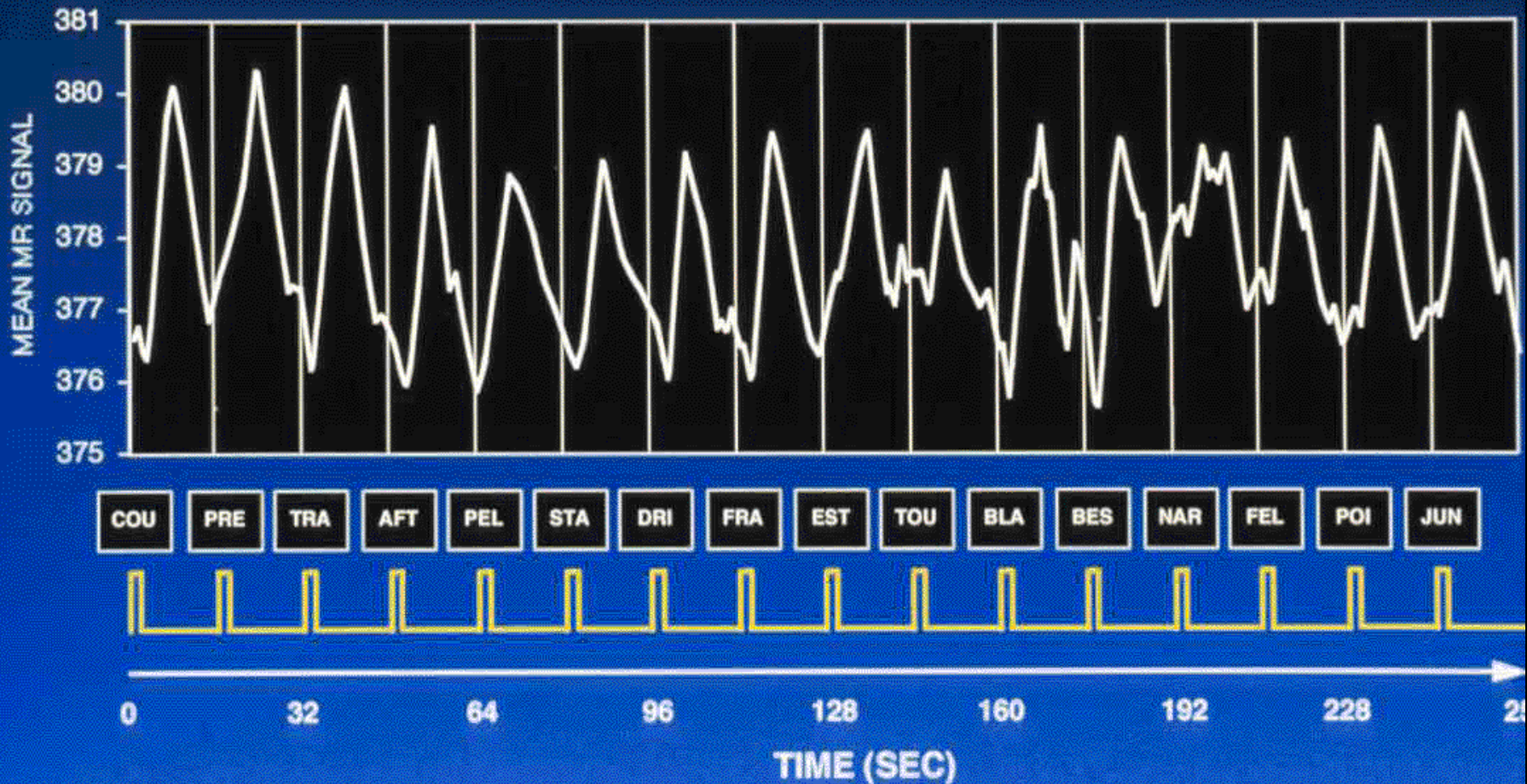

Detection of cortical activation during averaged single trials of a cognitive task using functional magnetic resonance imaging

(neuroimaging/single trial/language/prefrontal)

RANDY L. BUCKNER^{†‡§¶}, PETER A. BANDETTINI^{†‡}, KATHLEEN M. O' CRAVEN^{†||}, ROBERT L. SAVOY^{†||},
STEVEN E. PETERSEN^{**††}, MARCUS E. RAICHEL^{§**††}, AND BRUCE R. ROSEN^{†‡}

Time Course Comparison Across Brain Regions

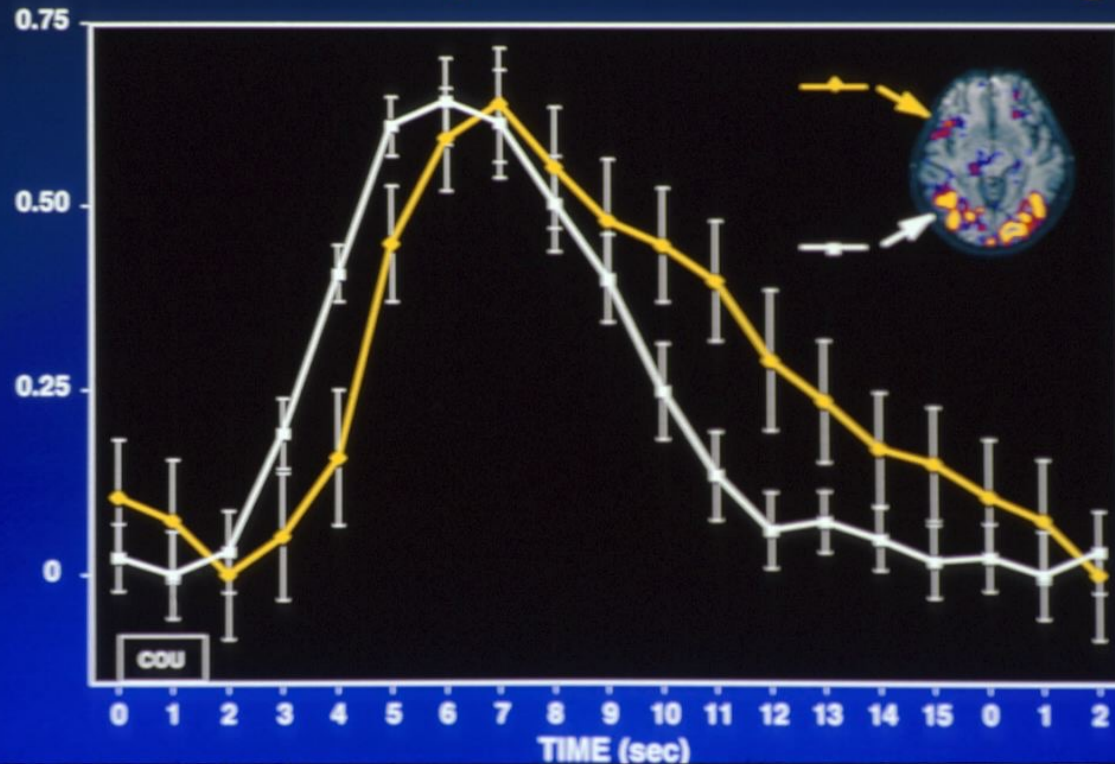

Event Related Advantages

- Task Randomization
- Post acquisition, Performance-based, data binning
- Natural presentation
- Reduction of habituation effects
- Overt responses
- Reduction of scanner noise effects
- More precise estimation of hemodynamic responses

Speaking - Blocked Trial

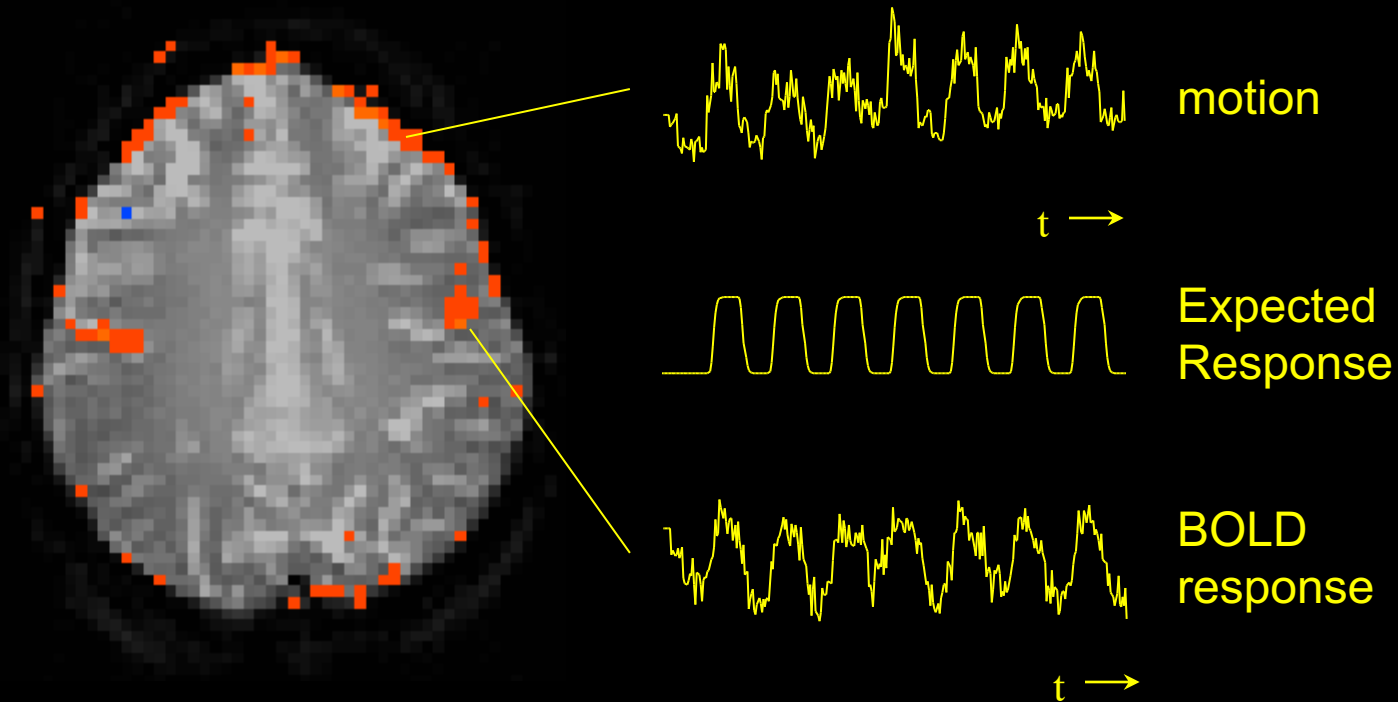

fMRI during tasks that involve brief motion

Blocked Design

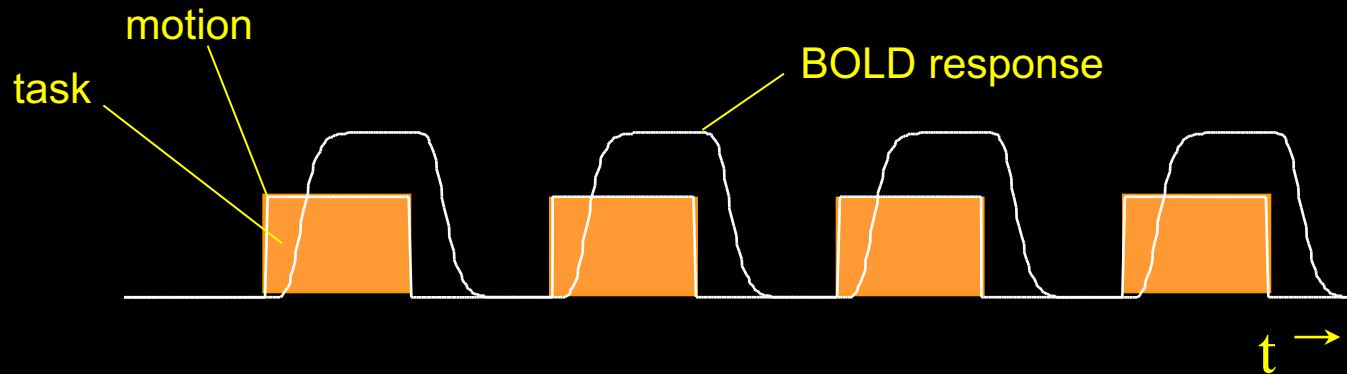

Event-Related Design

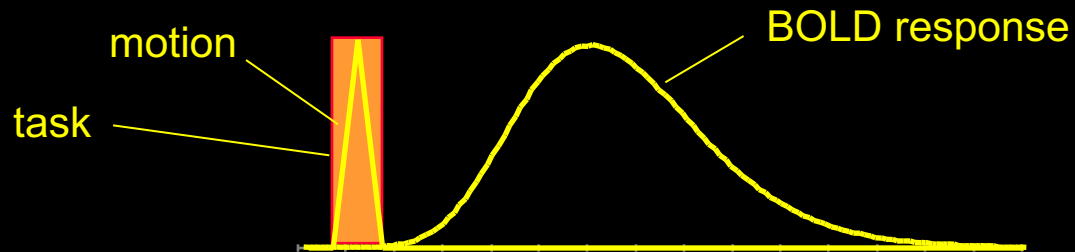

R. M. Birn, P. A. Bandettini, R. W. Cox, R. Shaker, Event - related fMRI of tasks involving brief motion. *Human Brain Mapping* 7: 106-114 (1999).

Overt Word Production

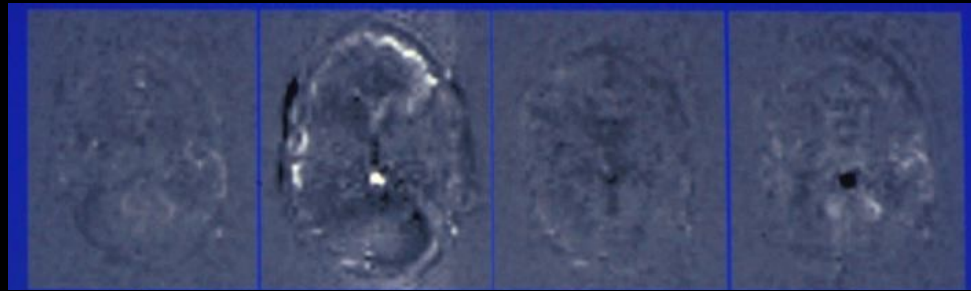

2

3

4

5

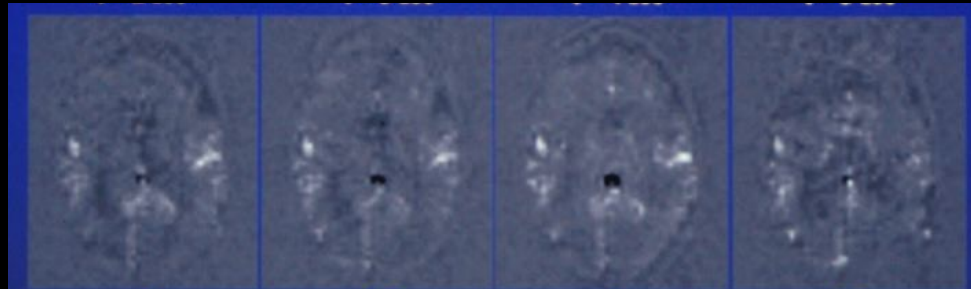

6

7

8

9

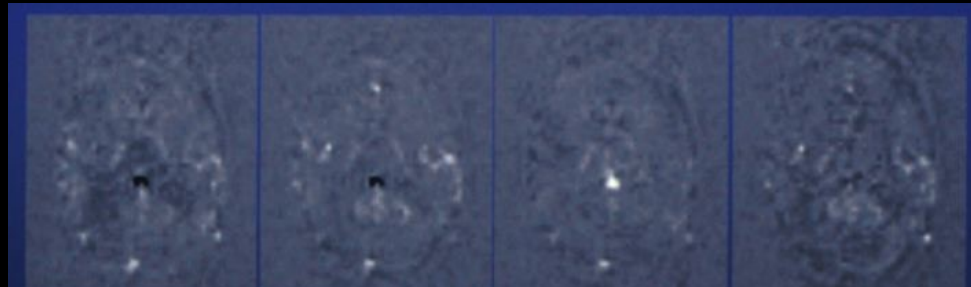

10

11

12

13

R. M. Birn, P. A. Bandettini, R. W. Cox, R. Shaker, Event - related fMRI of tasks involving brief motion. *Human Brain Mapping* 7: 106-114 (1999).

Speaking - ER-fMRI

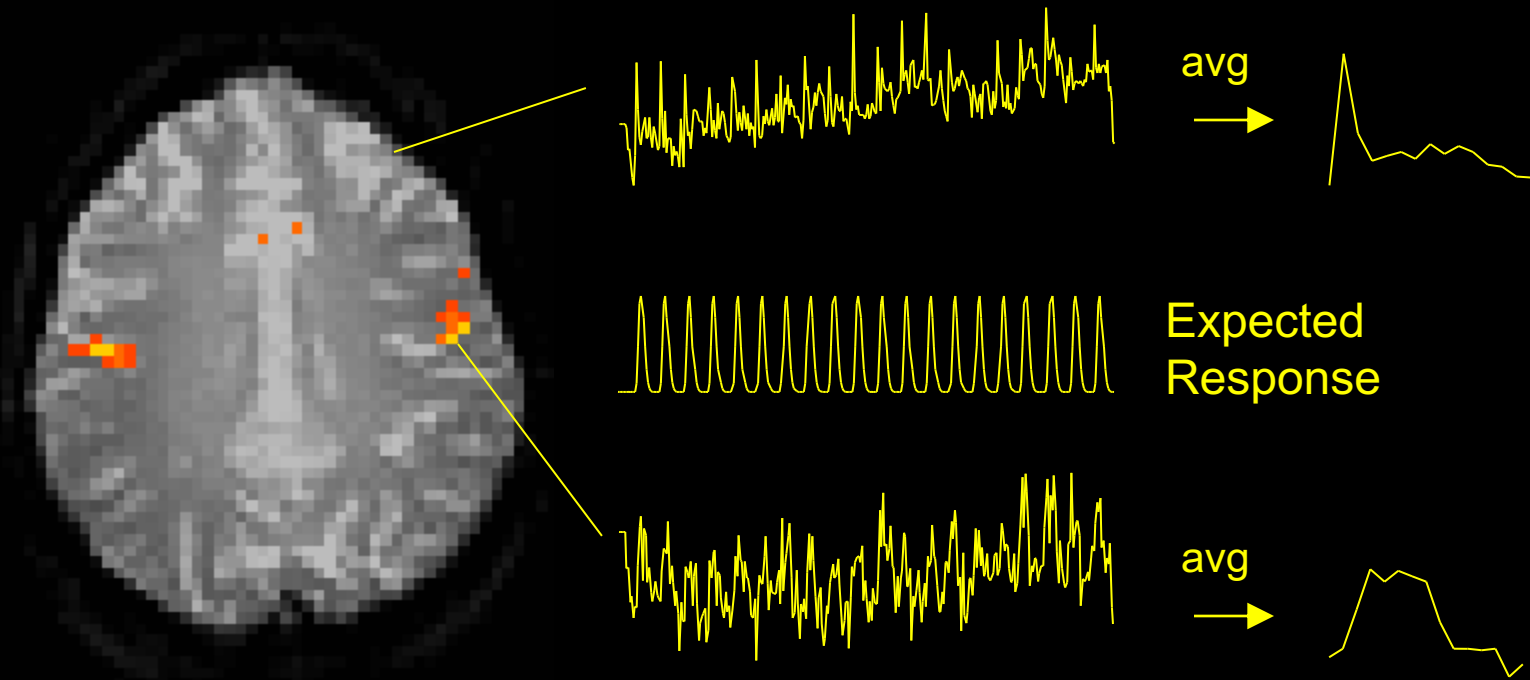

R. M. Birn, P. A. Bandettini, R. W. Cox, R. Shaker, Event - related fMRI of tasks involving brief motion. *Human Brain Mapping* 7: 106-114 (1999).

Tongue Movement

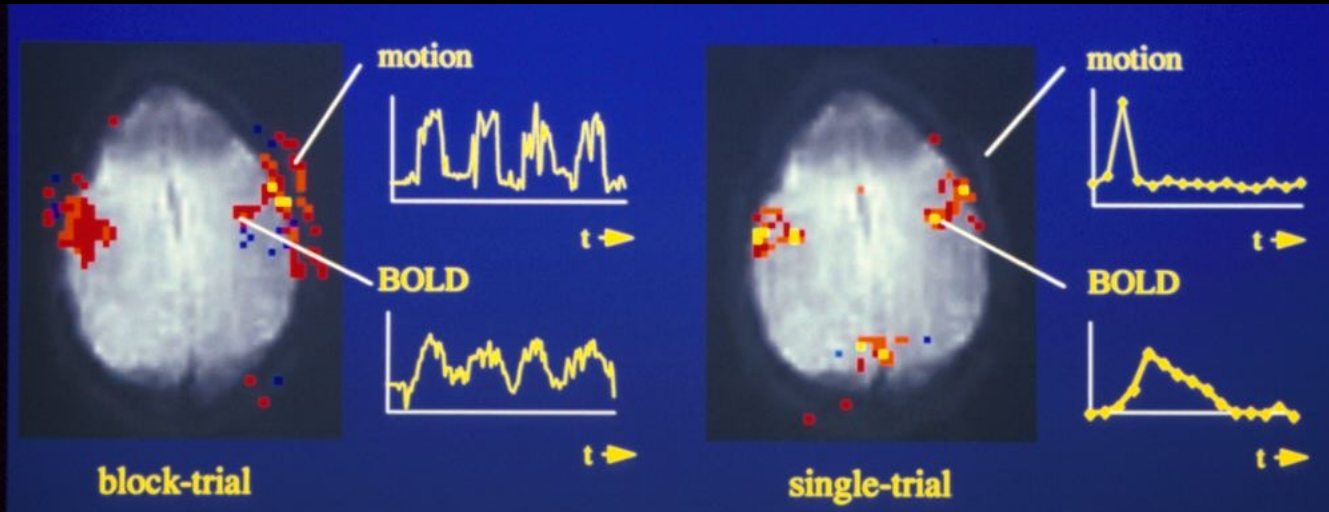

Jaw Clenching

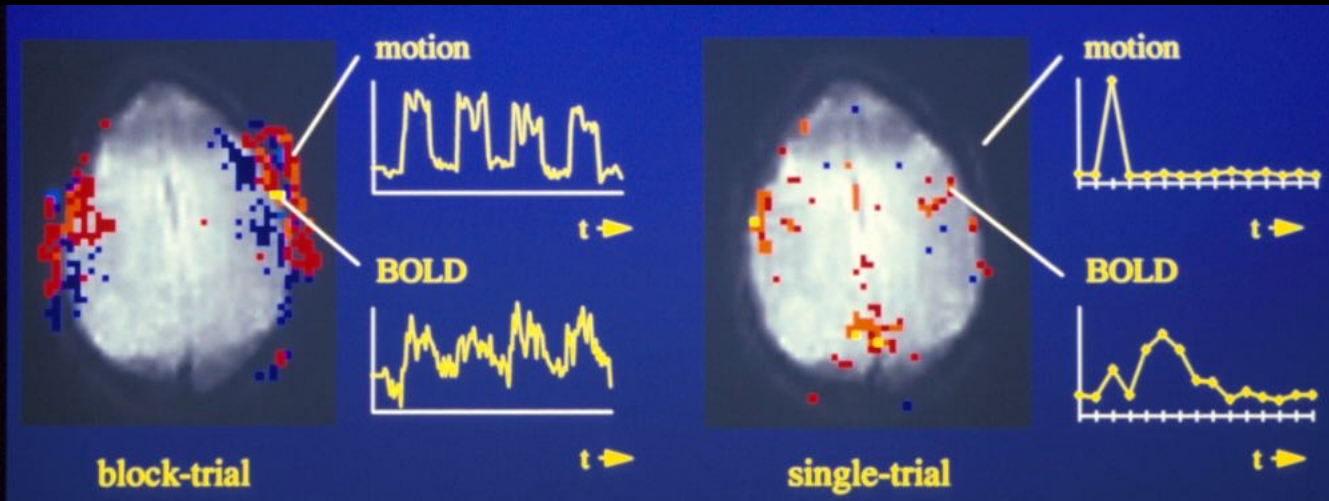

Motion

Recognize?

- Edge effects
- Shorter signal change latencies
- Unusually high signal changes
- External measuring devices

Correct?

- Image registration algorithms
- Orthogonalize to motion-related function (*cardiac, respiration, movement*)
- Navigator echo for k-space alignment
(*for multishot techniques*)
- Re-do scan

Bypass?

- Paradigm timing strategies..
- Gating (with T1-correction)

Suppress?

- Flatten image contrast
- Physical restraint
- Averaging, smoothing

Visual Cortex



ISI, SD

ISI, SD

20, 20

8, 2

12, 2

6, 2

10, 2

4, 2

2, 2

Motor Cortex

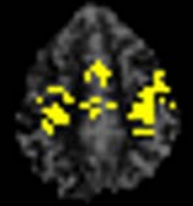

ISI, SD

ISI, SD

20, 20

8, 2

12, 2

6, 2

10, 2

4, 2

2, 2

Functional Contrast

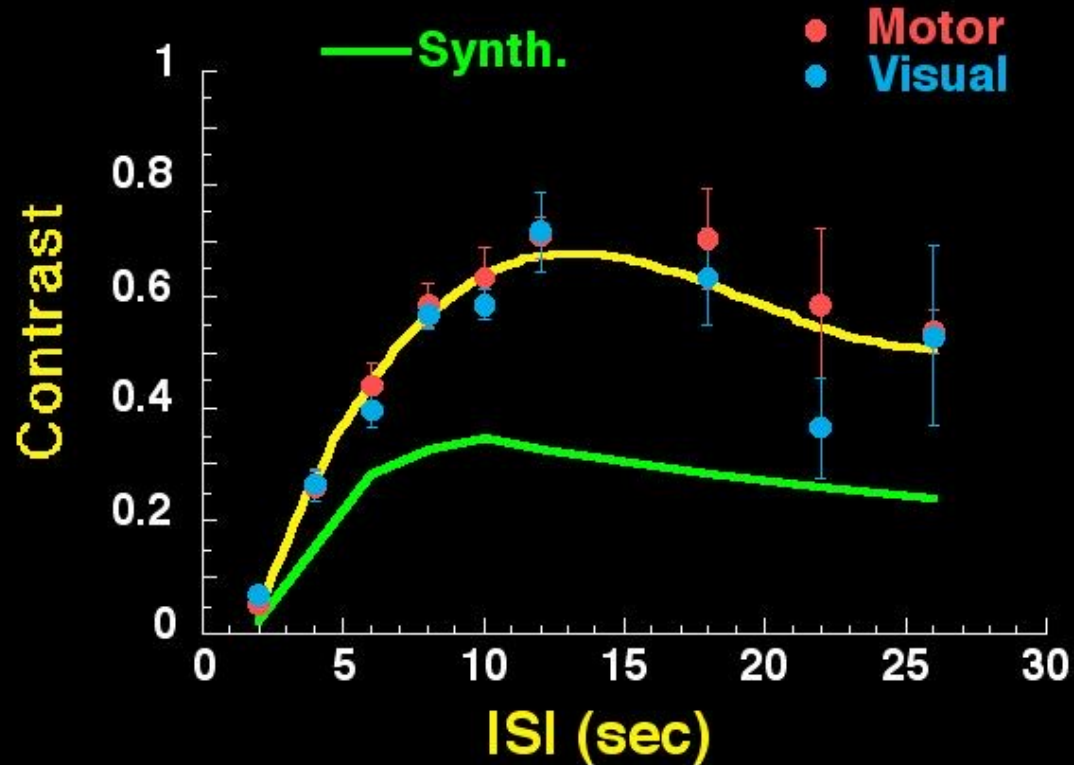

(Block design = 1)

P. A. Bandettini, R. W. Cox. Functional contrast in constant interstimulus interval event - related fMRI: theory and experiment. *Magn. Reson. Med.* 43: 540-548 (2000).

Contrast to Noise Images

(ISI, SD)

20, 20

12, 2

10, 2

8, 2

6, 2

4, 2

2, 2

S1

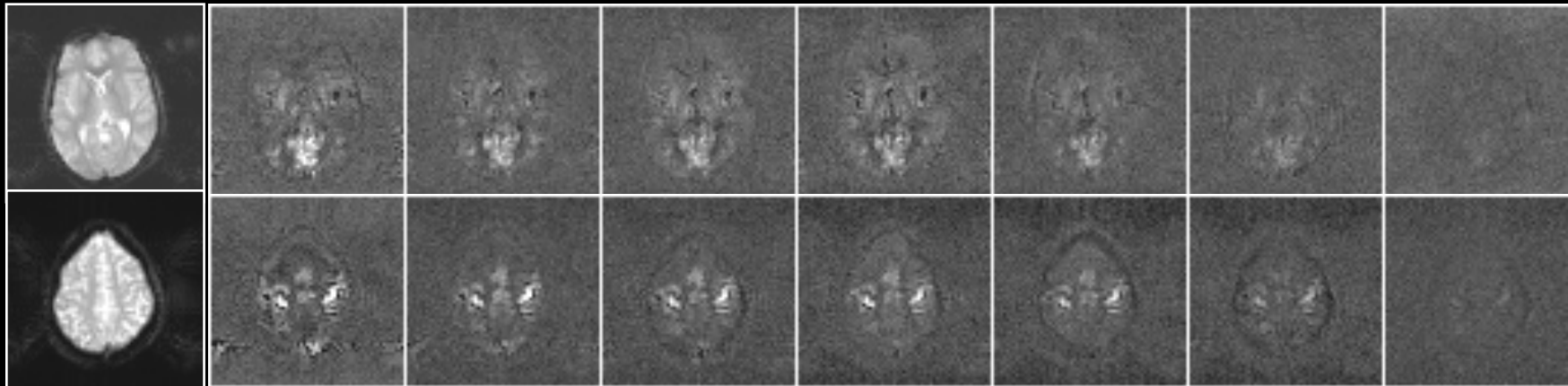

S2

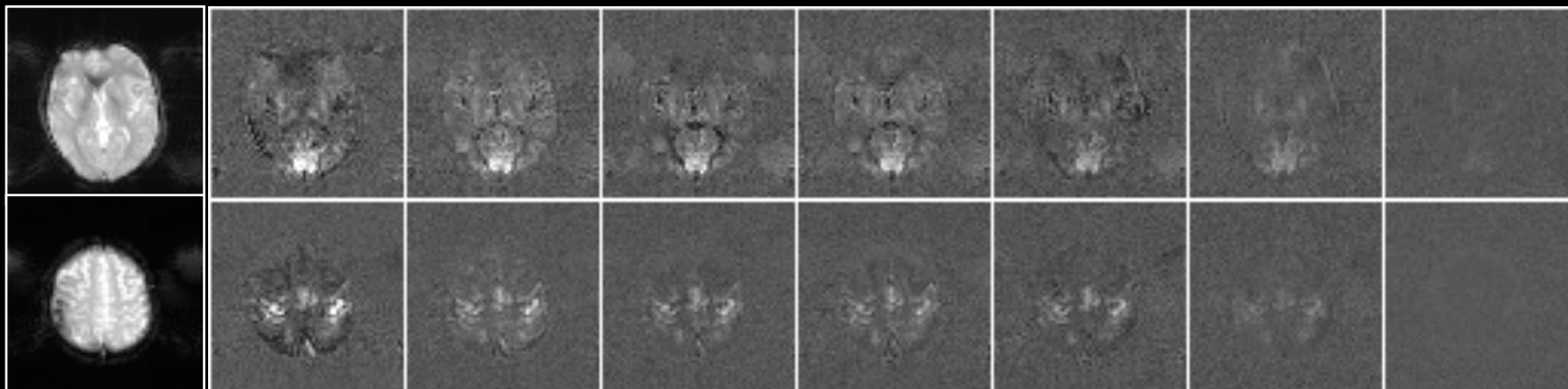

P. A. Bandettini, R. W. Cox. Functional contrast in constant interstimulus interval event - related fMRI: theory and experiment. *Magn. Reson. Med.* 43: 540-548 (2000).

Motor

Visual

(ISI, SD)

20, 20

2, 2

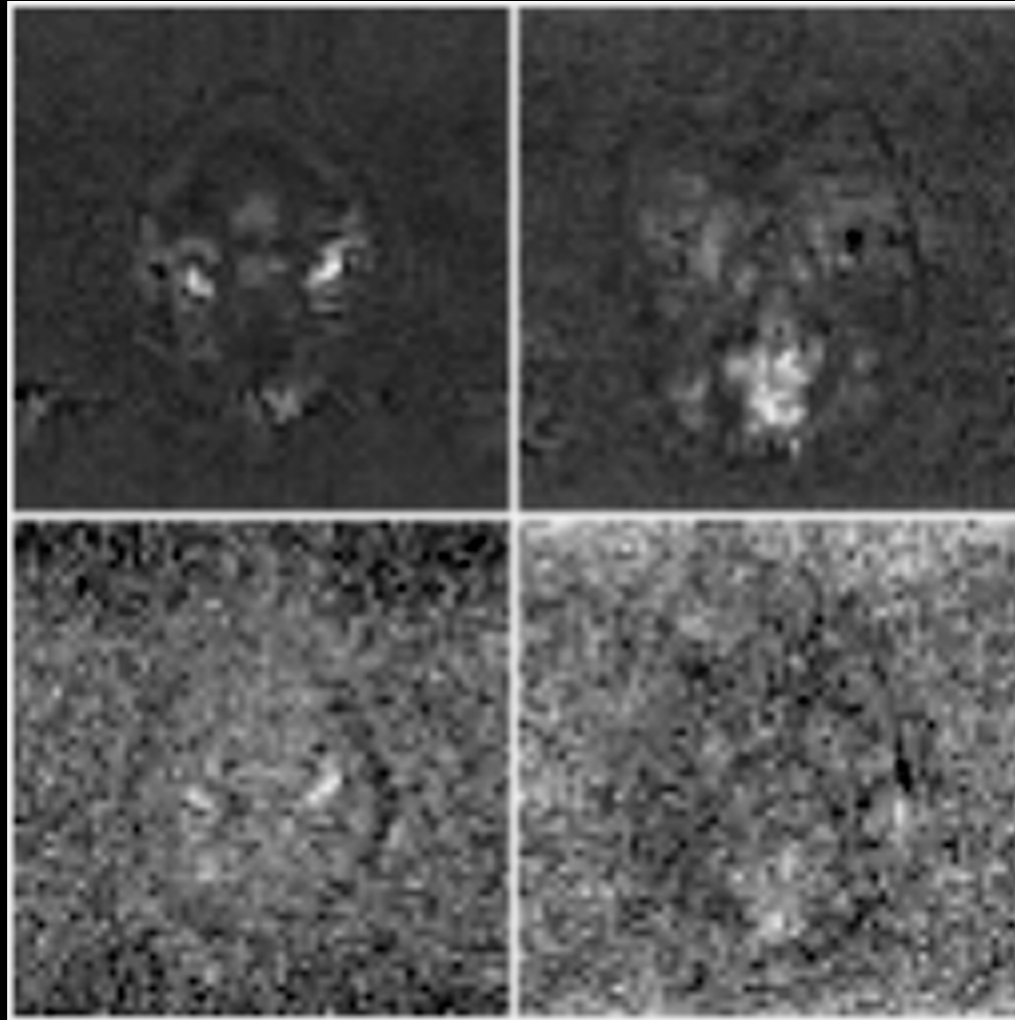

Relative differences in activation intensities may reflect spatial differences in hemodynamic responsivity. (draining veins vs. capillaries).

Motor Cortex

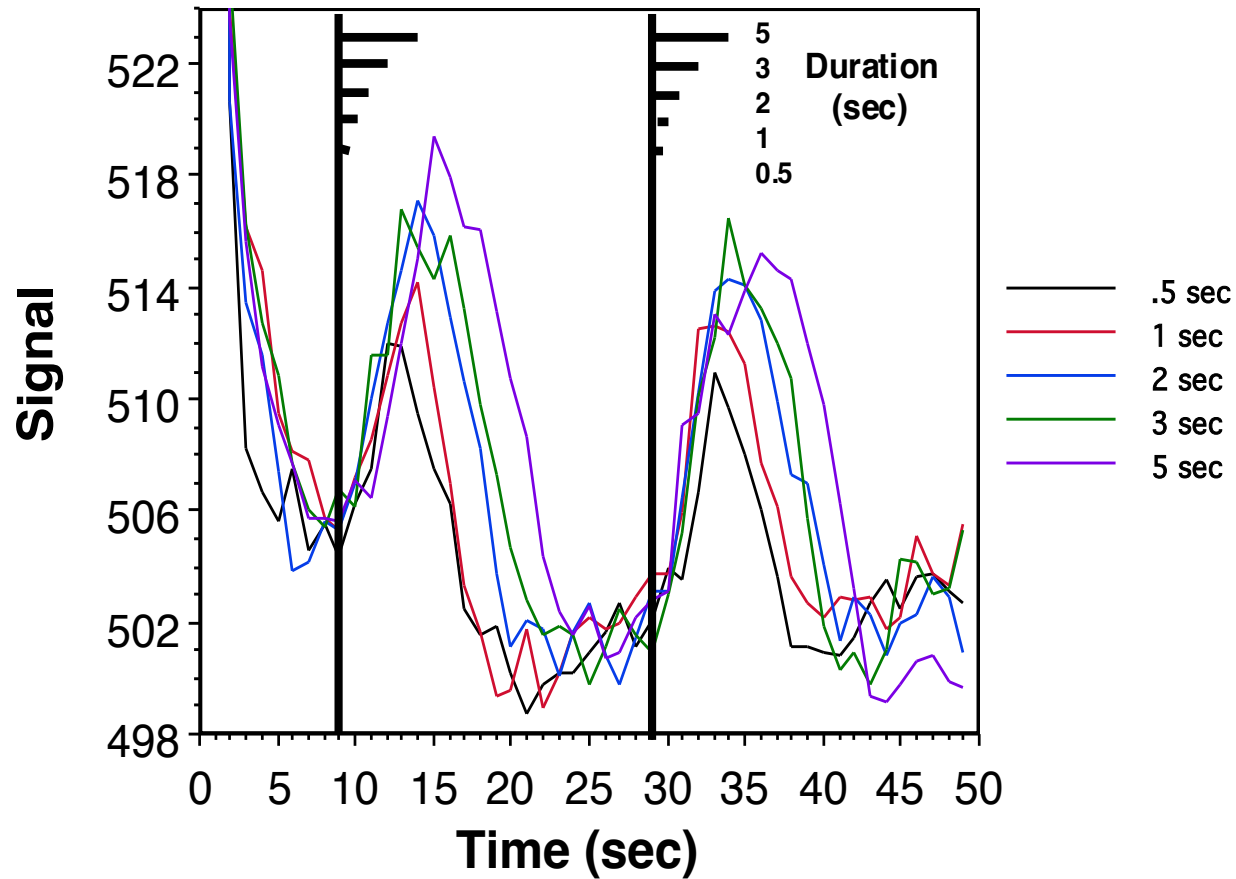

Bandettini, et al., The functional dynamics of blood oxygenation level contrast in the motor cortex, 12'th Proc. Soc. Magn. Reson. Med., New York, p. 1382. (1993).



0 sec

20 sec

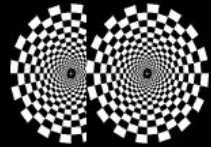

0 sec 2 sec

20 sec

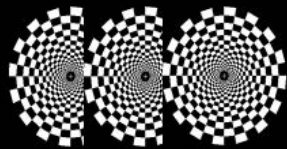

0 sec 2 sec 4 sec

20 sec

Selective Averaging of Rapidly Presented Individual Trials Using fMRI

Anders M. Dale* and Randy L. Buckner

RAW DATA

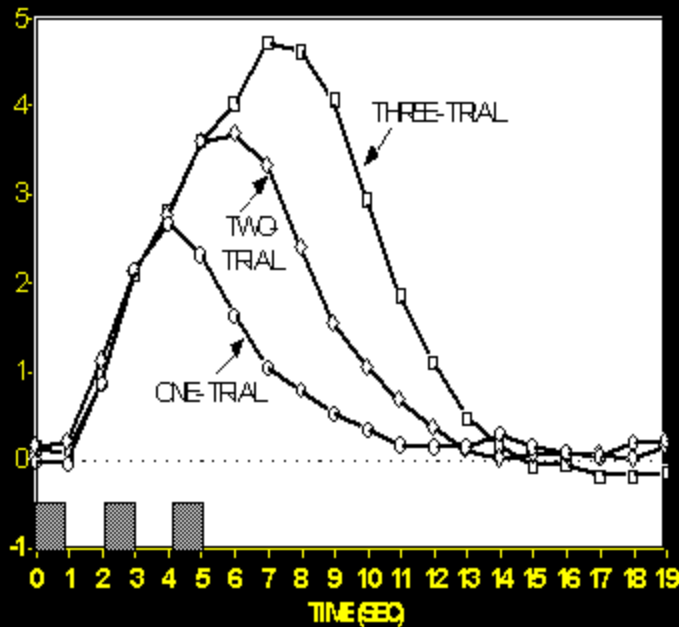

ESTIMATED RESPONSES

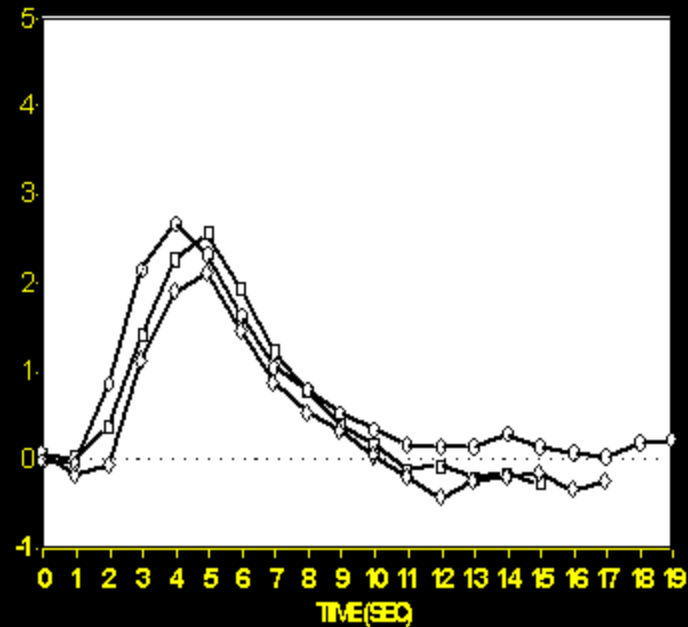

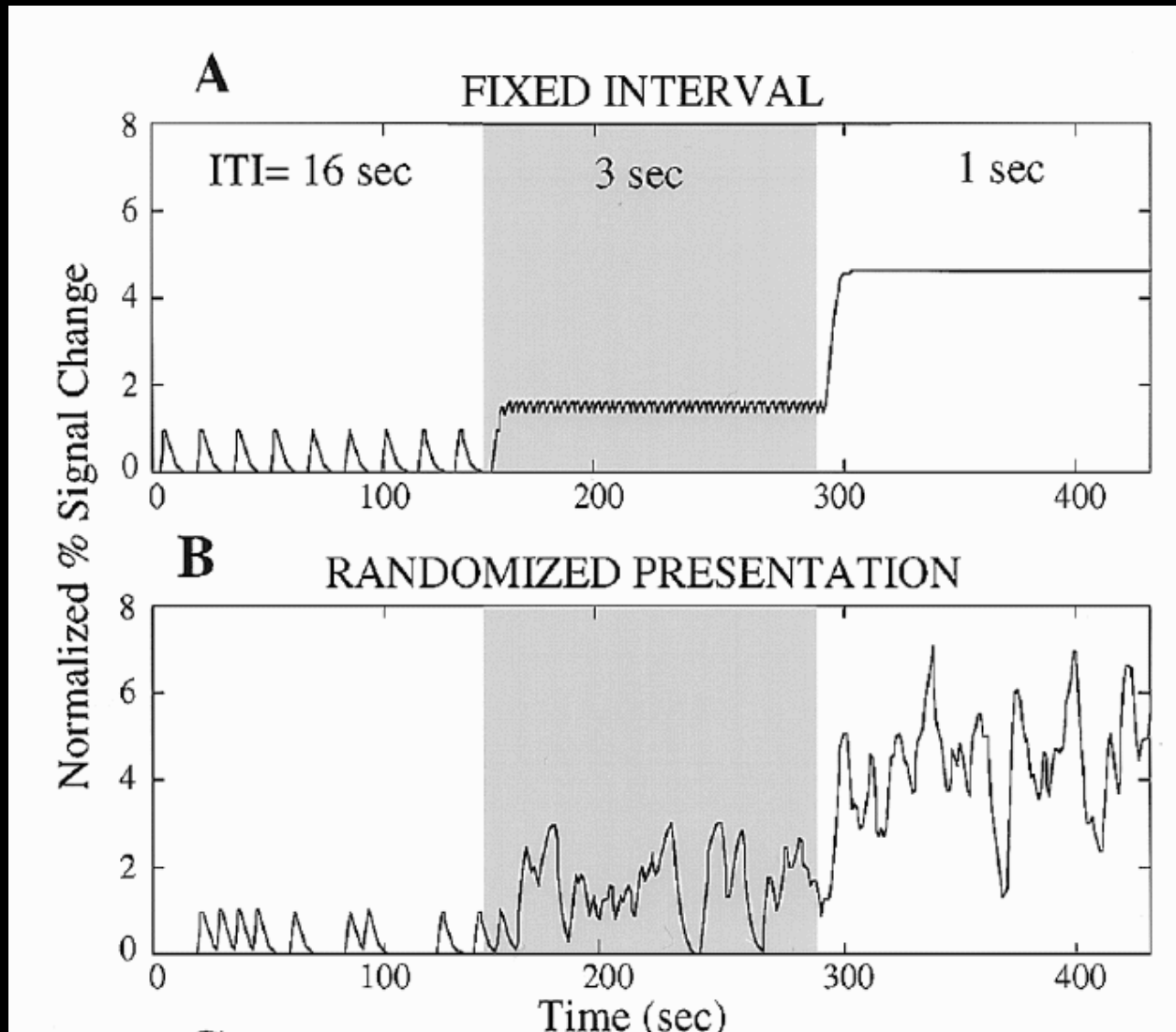

M.A. Burock et al. *NeuroReport*, 9, 3735-9 (1998)

Detectability – constant ISI

SD – stimulus duration

ISI – inter-stimulus interval

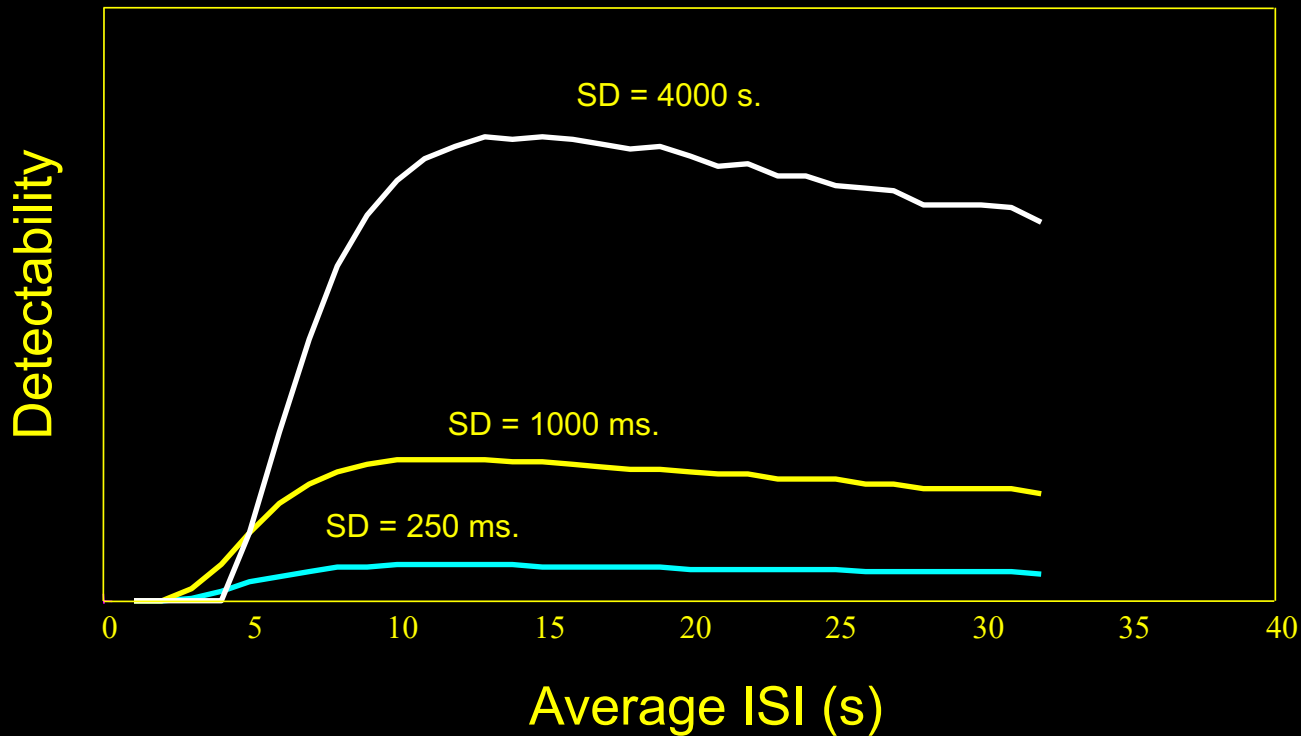
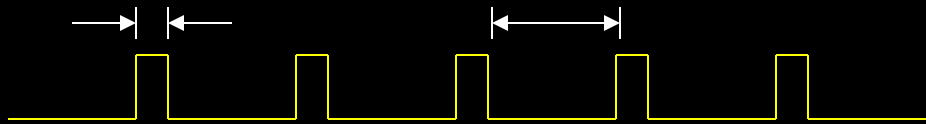

Detectability vs. Average ISI

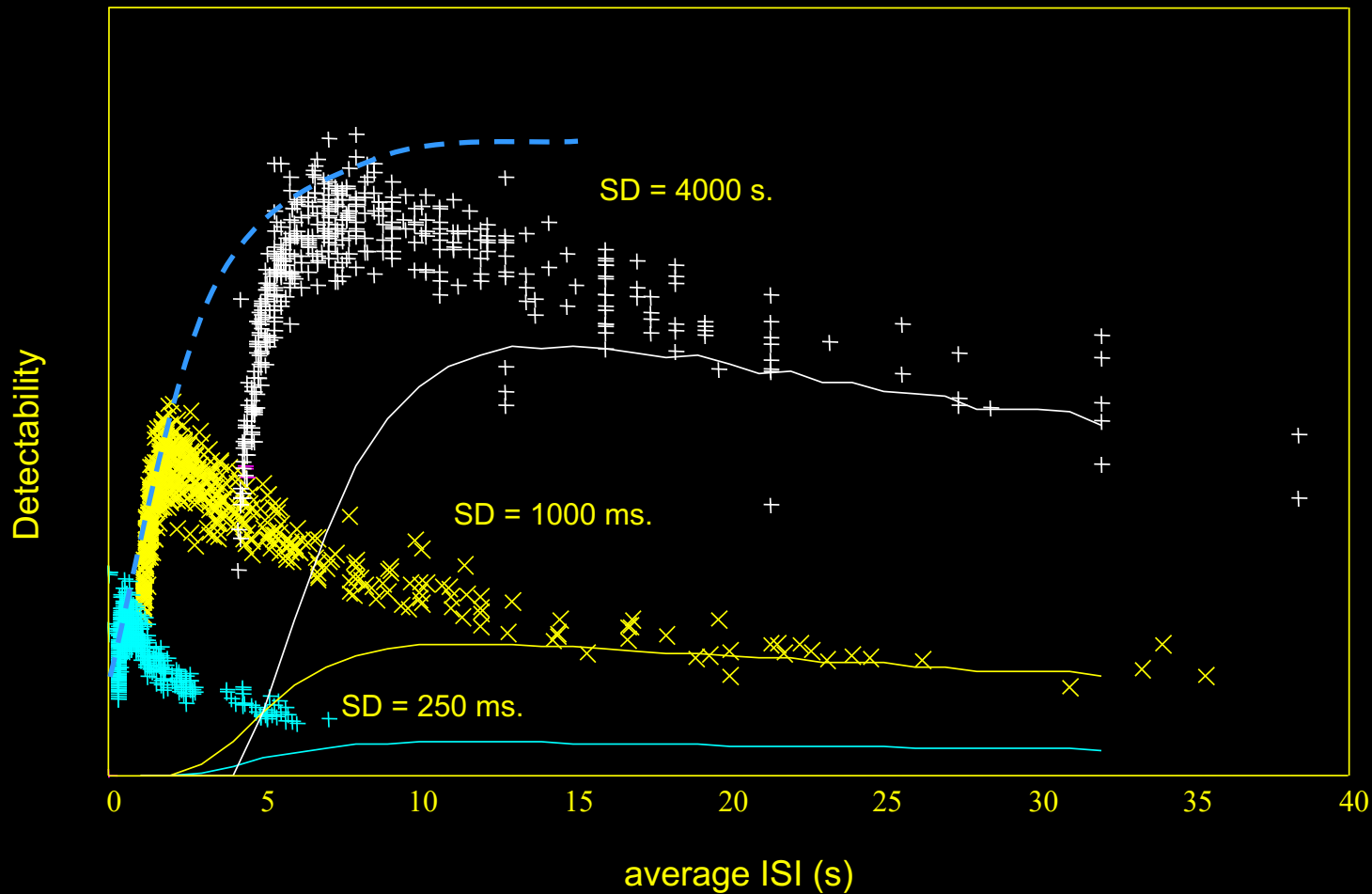

R. M. Birn, R. W. Cox, P. A. Bandettini, Detection versus estimation in Event-Related fMRI: choosing the optimal stimulus timing. *NeuroImage* 15: 262-264, (2002).

Estimation accuracy vs. average ISI

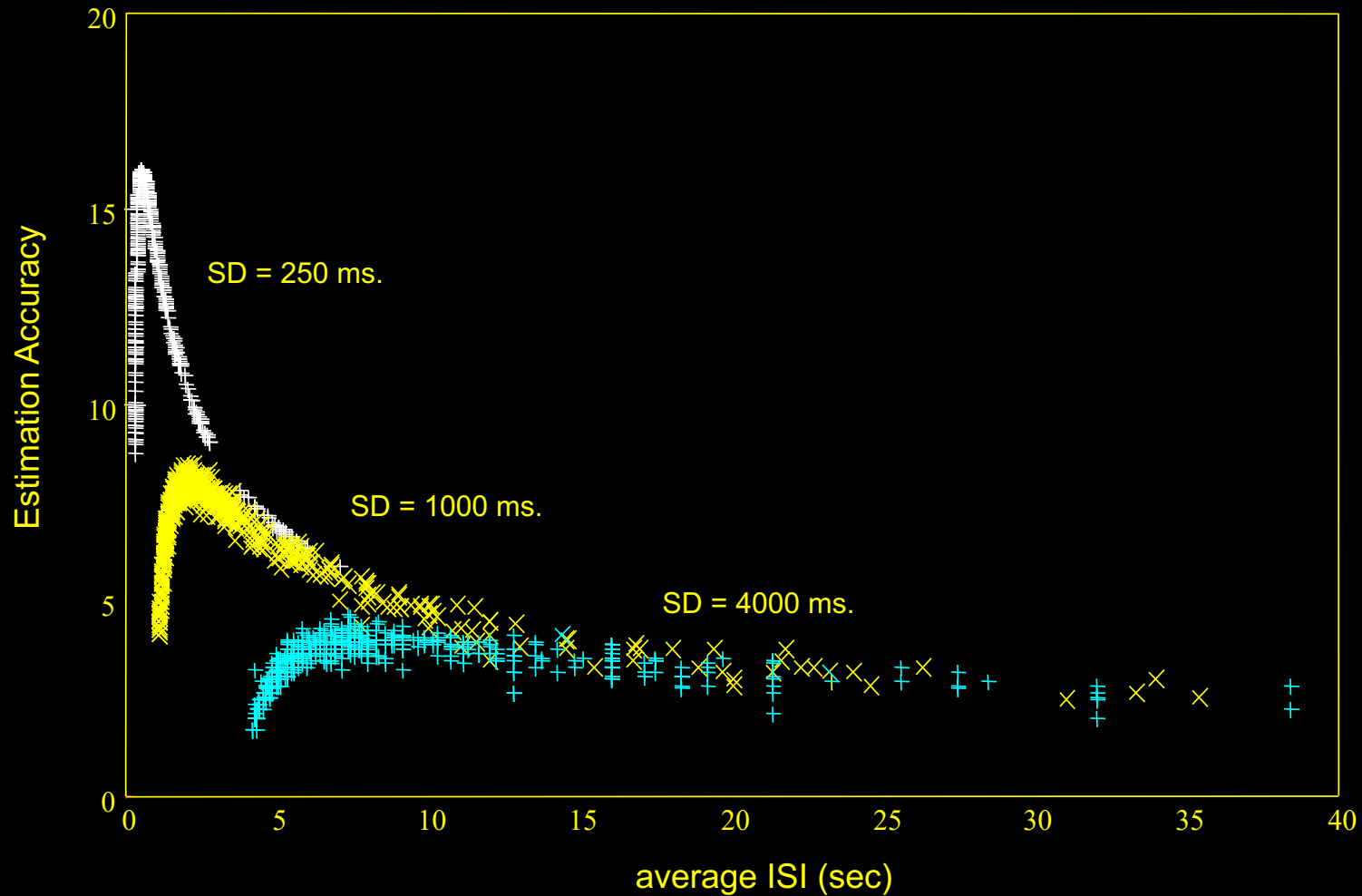

R. M. Birn, R. W. Cox, P. A. Bandettini, Detection versus estimation in Event-Related fMRI: choosing the optimal stimulus timing. *NeuroImage* 15: 262-264, (2002).

Estimation accuracy vs. average ISI

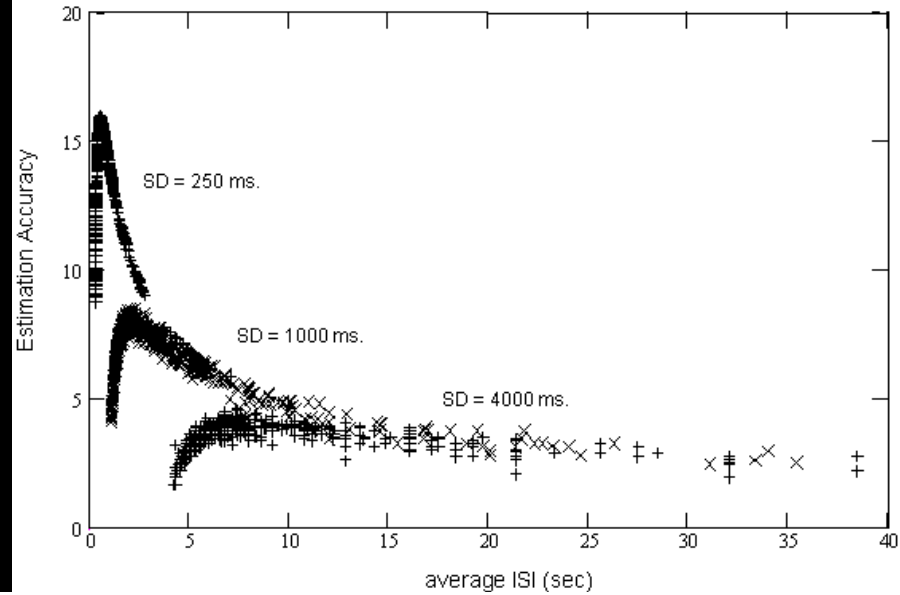

Detectability vs. Average ISI

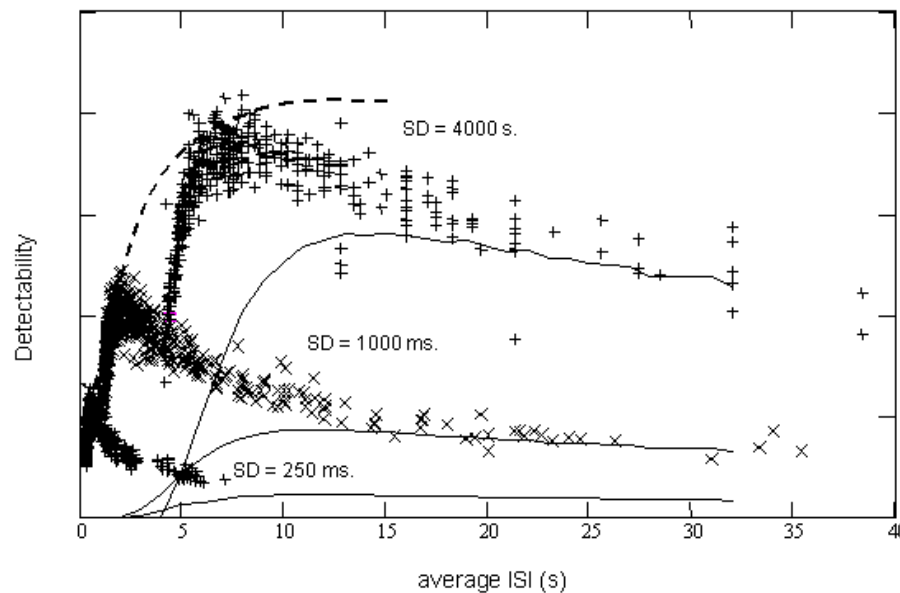

Varying “ON” and “OFF” periods

- *Rapid event-related design with varying ISI*



Varying “ON” and “OFF” periods

*Estimated
Impulse Response*

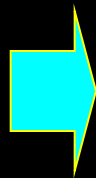
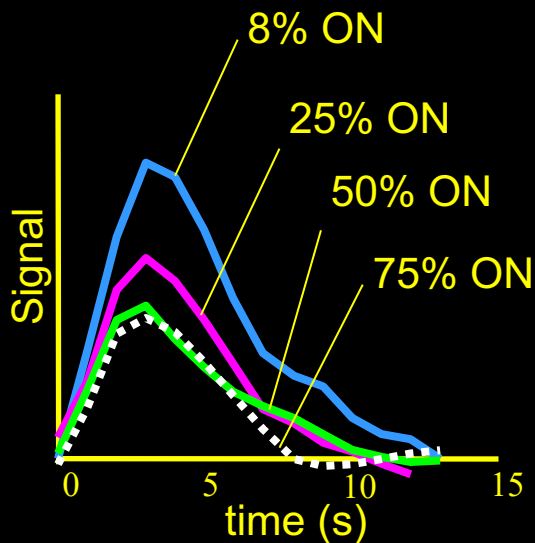

*Predicted Responses
to 20 s stimulation*

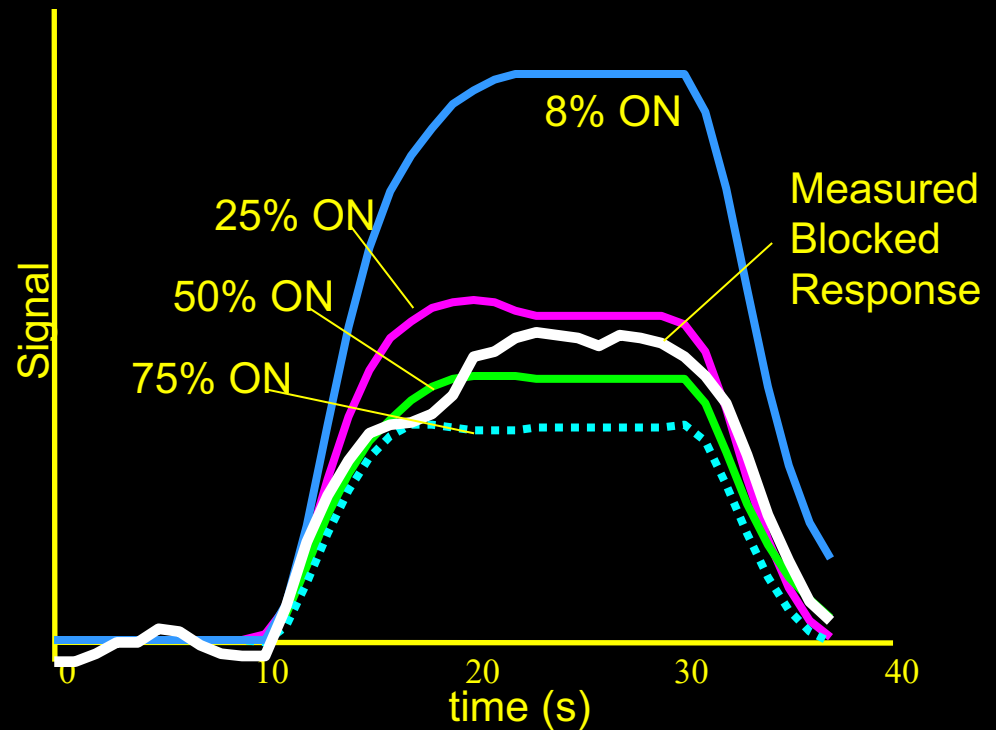

Neuronal Activation Input Strategies

1. Block Design

2. Parametric Design

3. Frequency Encoding

4. Phase Encoding

5. Event Related

6. Orthogonal Design

7. Free Behavior Design

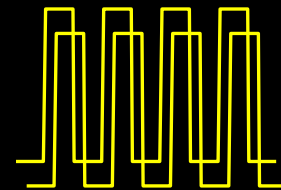
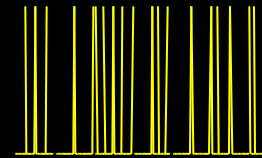
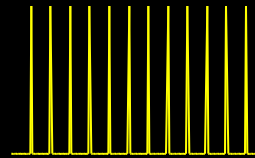
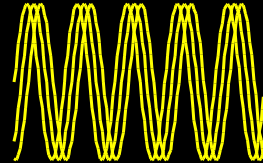
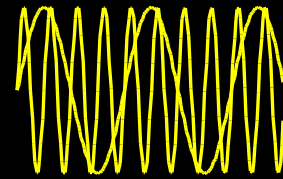
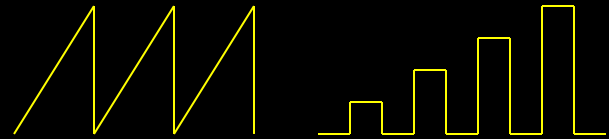

Example of a Set of Orthogonal Contrasts for Multiple Regression

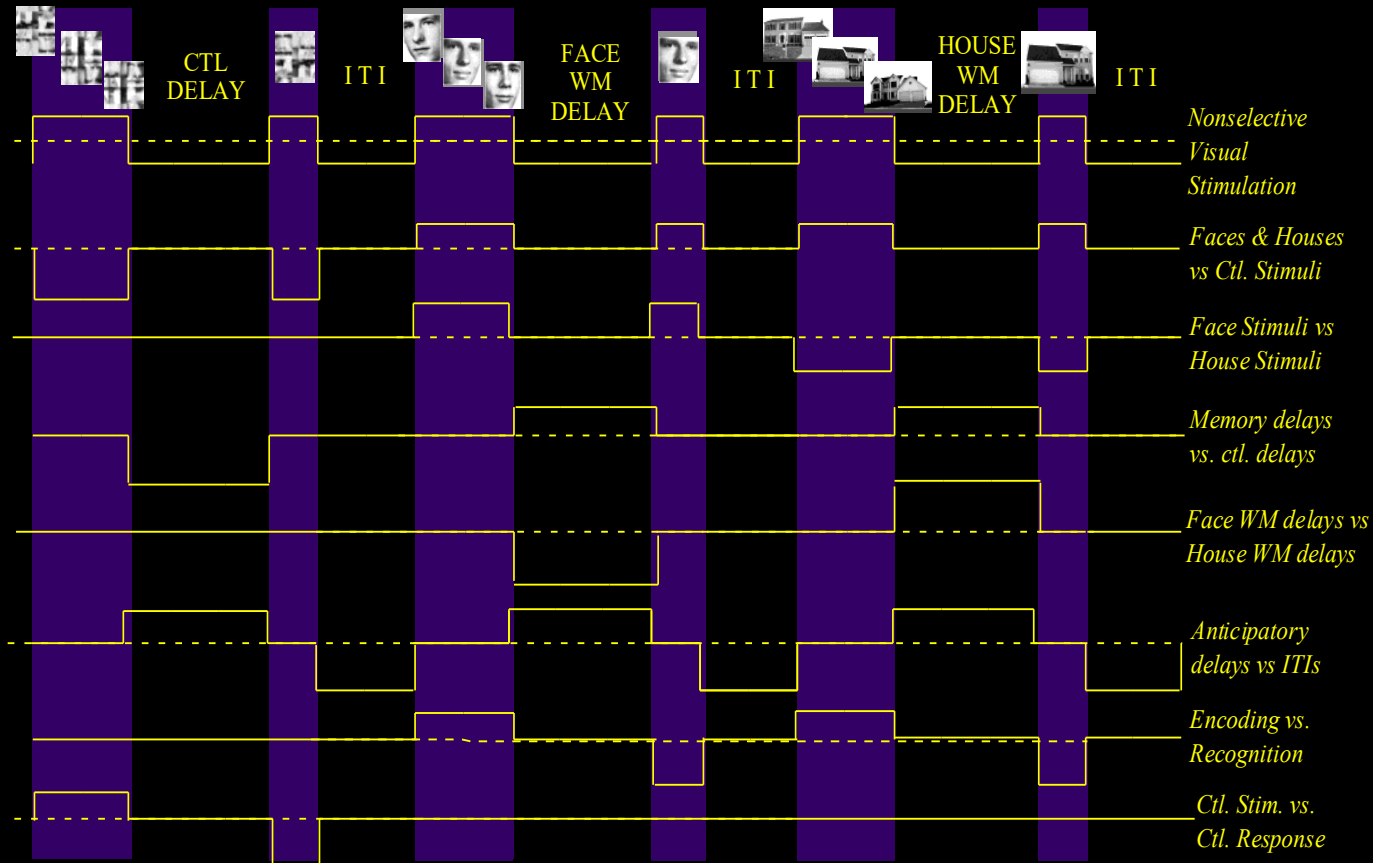

Courtney, S. M., L. G. Ungerleider, et al. (1997). "Transient and sustained activity in a distributed neural system for human working memory." Nature 386(6625): 608-11.

Neuronal Activation Input Strategies

1. Block Design

2. Parametric Design

3. Frequency Encoding

4. Phase Encoding

5. Event Related

6. Orthogonal Design

7. Free Behavior Design

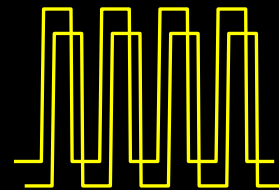
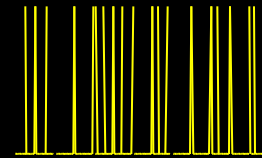
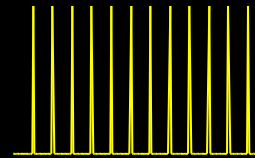
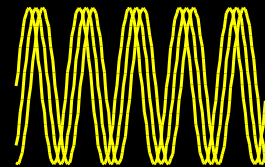
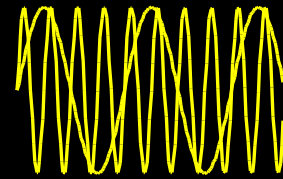
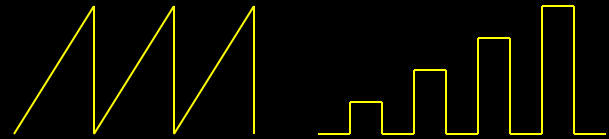

Free Behavior Design

Use a continuous measure as a reference function:

- Task performance
- Skin Conductance
- Heart, respiration rate..
- Eye position
- EEG

The Skin Conductance Response (SCR)

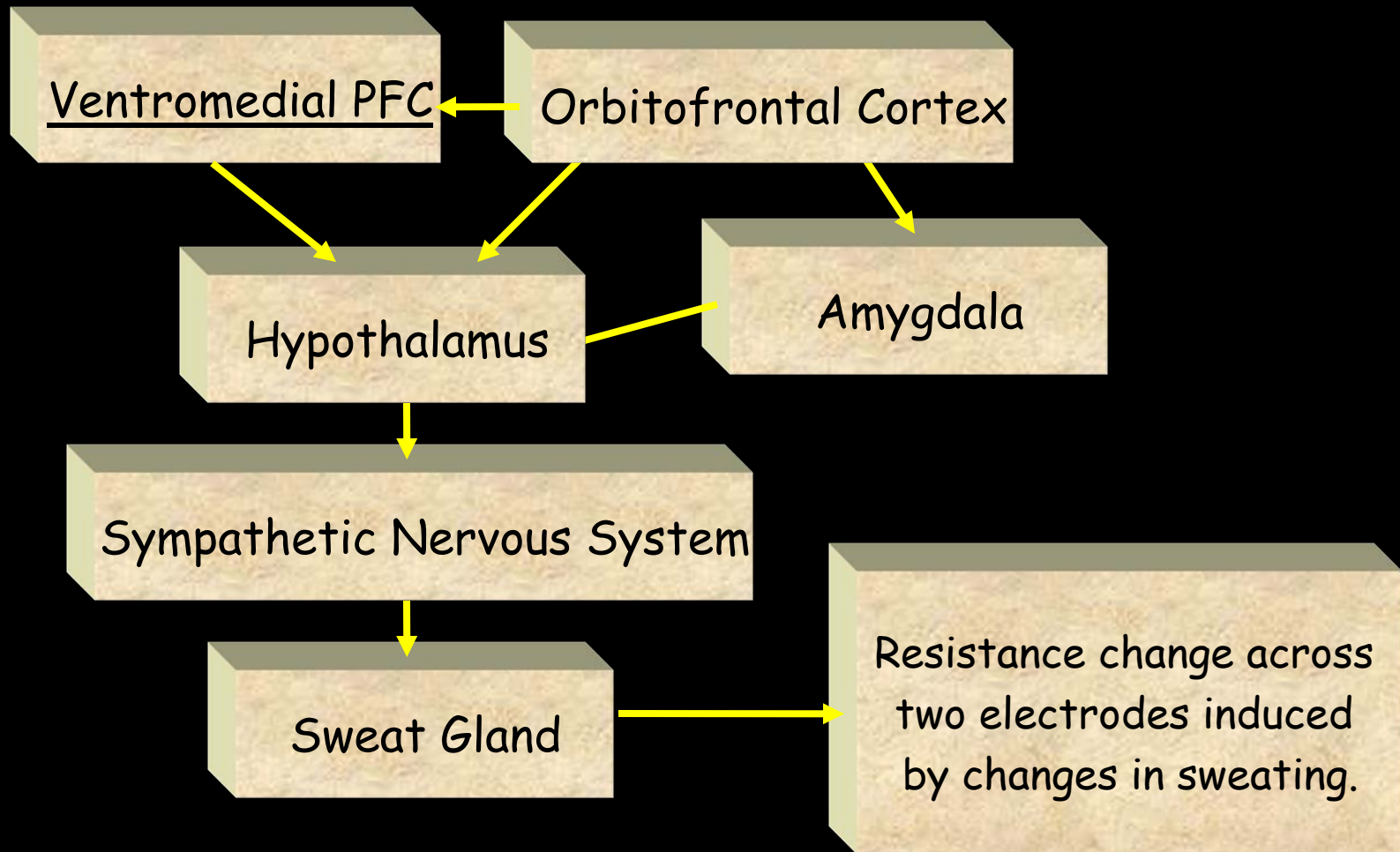

Patterson et al. (submitted)

Brain activity correlated with SCR during “Rest”

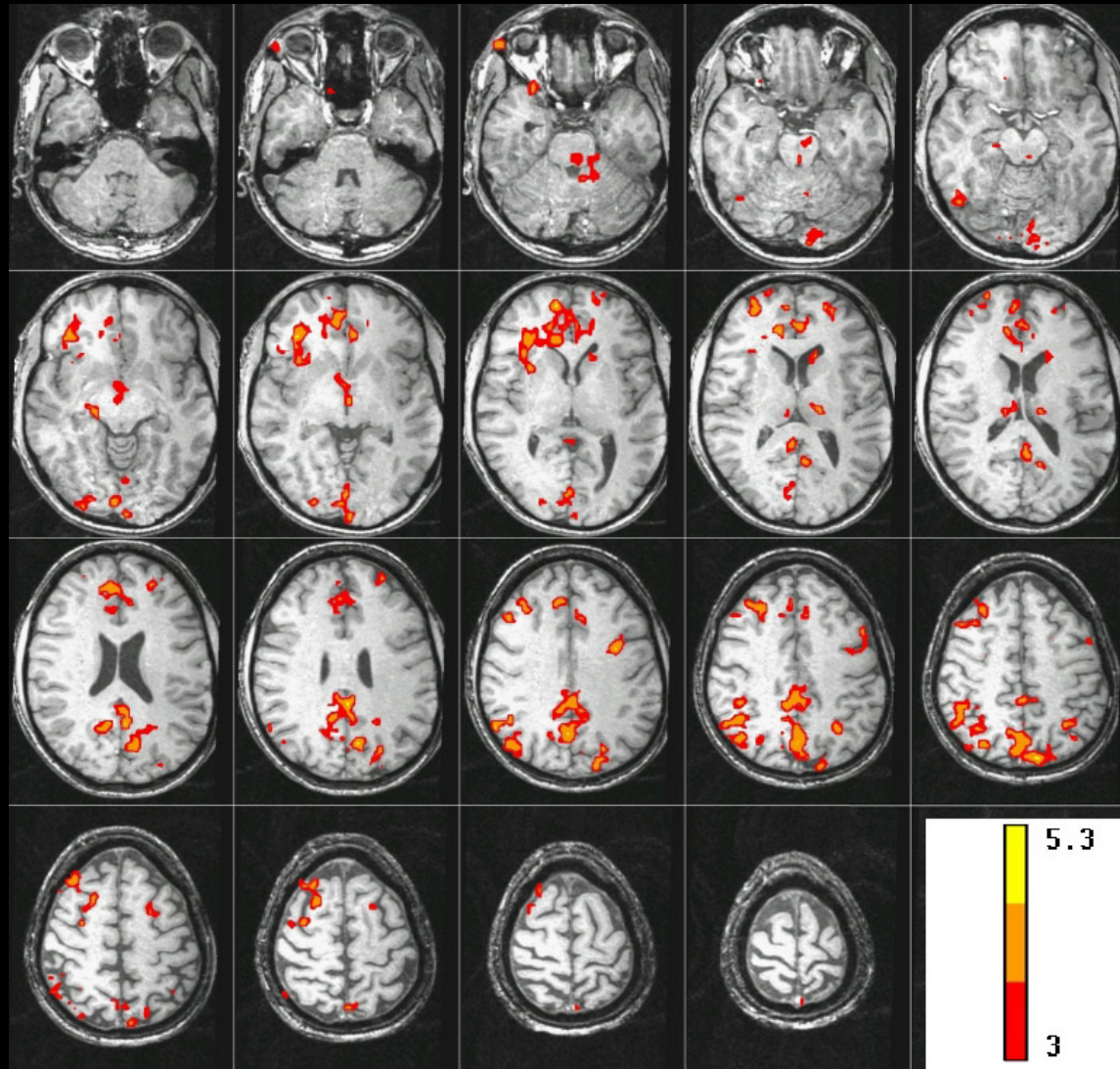

Patterson et al. (submitted)

Resting Hemodynamic Autocorrelations

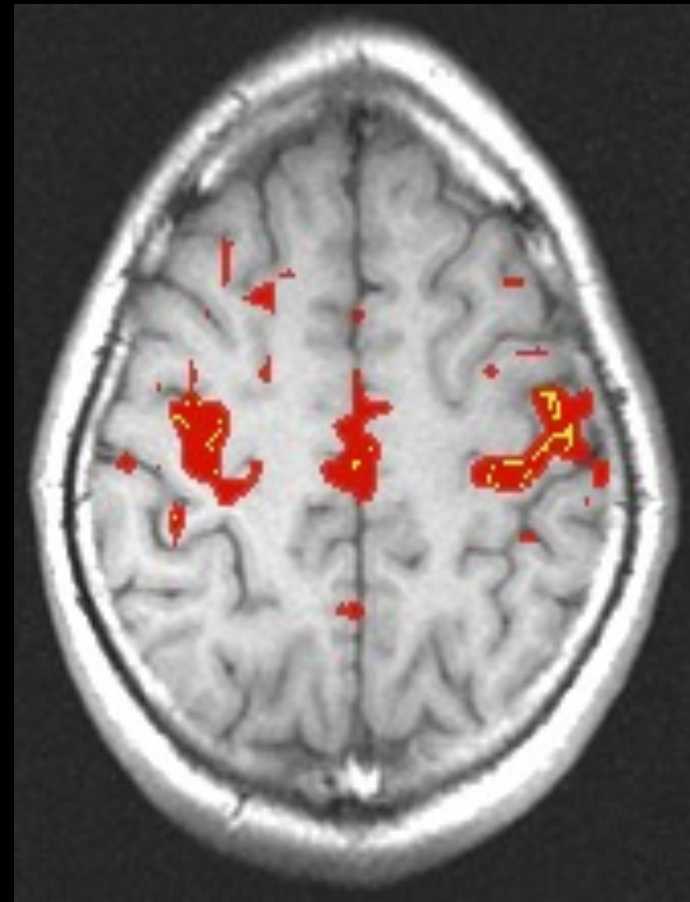
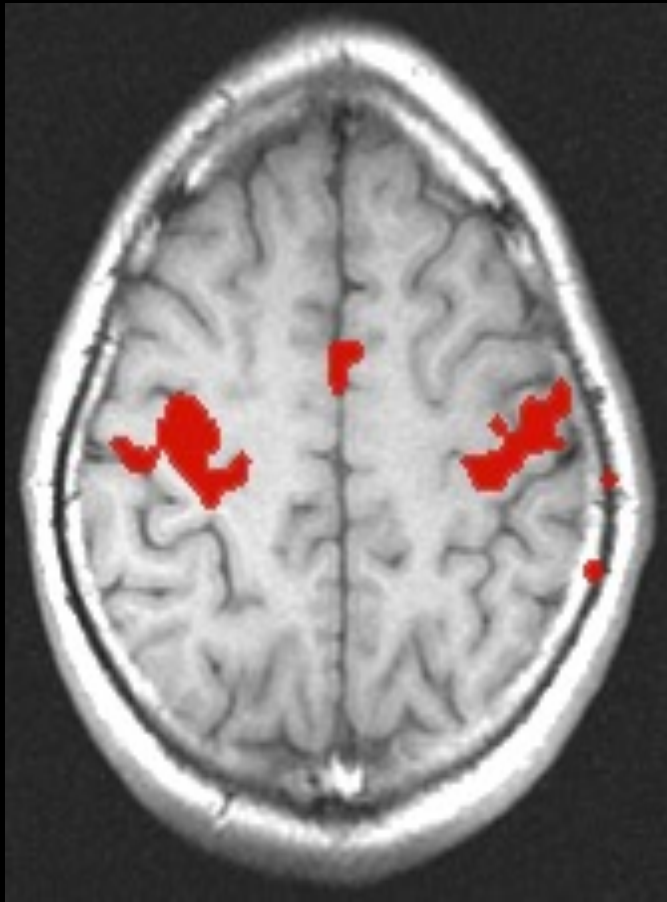

Calibration methods for Temporal Resolution and Interpretation...

Δ Neuronal Activity

Number of Neurons

Local Field Potential

Spiking Coherence

Spiking Rate

Δ Metabolism

Aerobic Metabolism

Anaerobic Metabolism

Δ Hemodynamics

Blood Volume

Deoxygenated Blood

Flow Velocity

Oxygenated Blood

Perfusion

Δ BOLD Contrast

Δ Perfusion Contrast

Δ Inflow Contrast

MRI Pulse Sequence

Δ Deoxy-Hb

-

-

+



Detection of cortical activation during averaged single trials of a cognitive task using functional magnetic resonance imaging

(neuroimaging/single trial/language/prefrontal)

RANDY L. BUCKNER^{†‡§¶}, PETER A. BANDETTINI^{†‡}, KATHLEEN M. O' CRAVEN^{†||}, ROBERT L. SAVOY^{†||},
STEVEN E. PETERSEN^{**††}, MARCUS E. RAICHEL^{§**††}, AND BRUCE R. ROSEN^{†‡}

Time Course Comparison Across Brain Regions

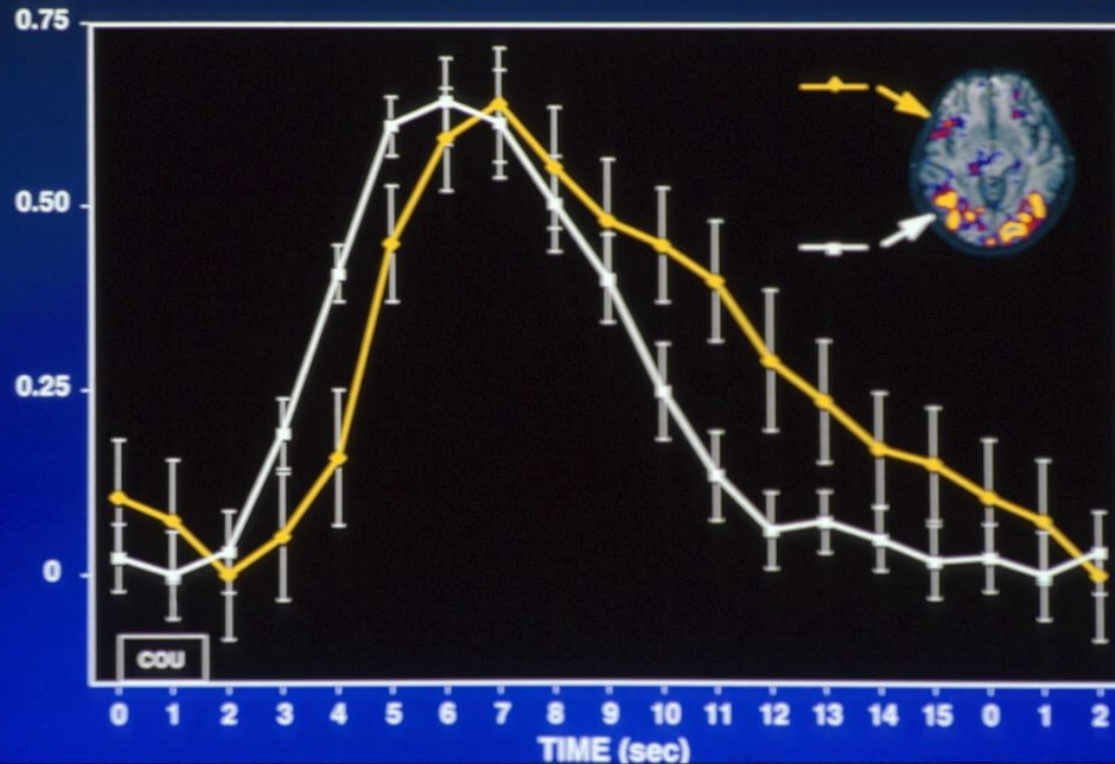

Latency

Magnitude

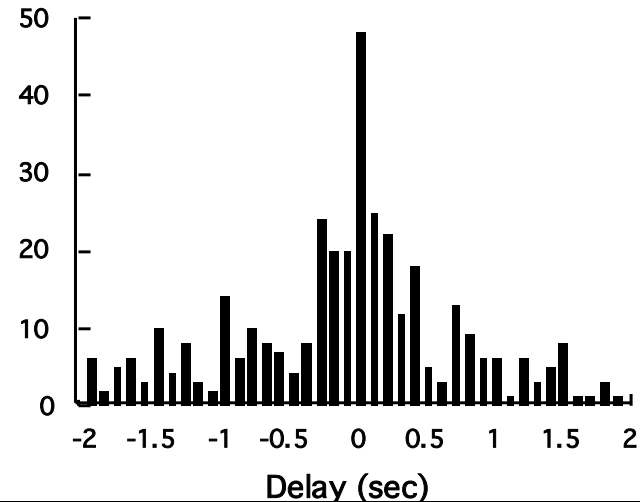
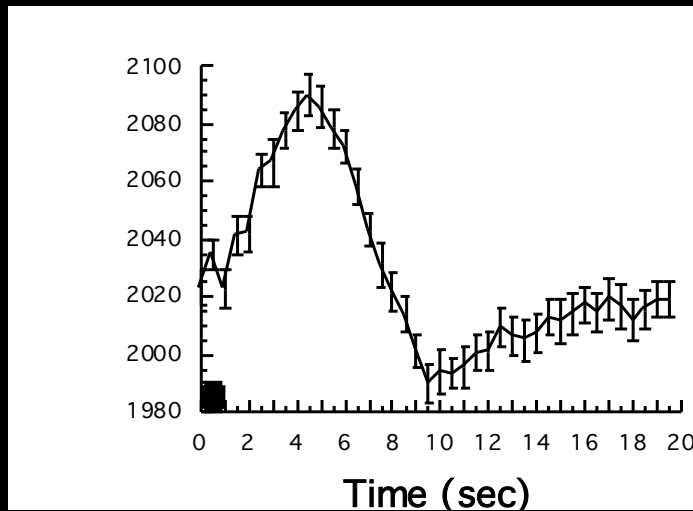
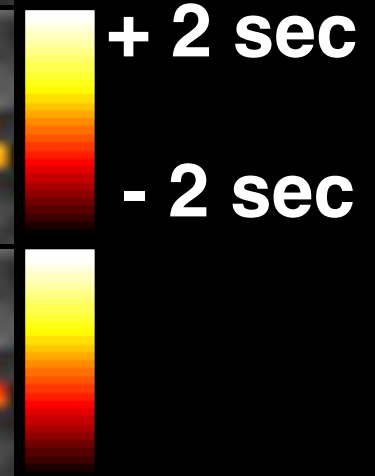
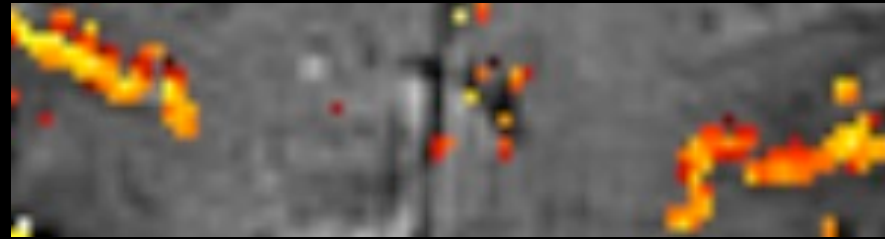
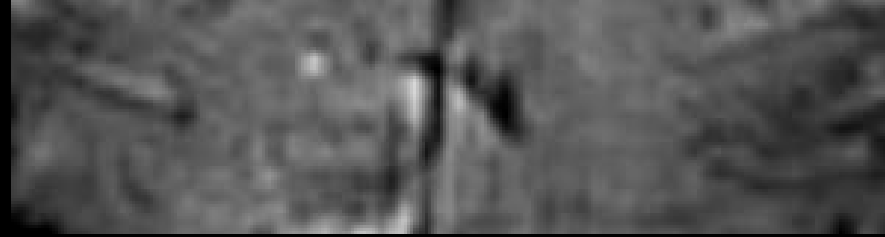

P. A. Bandettini, The temporal resolution of Functional MRI *in* "Functional MRI" (C. Moonen, and P. Bandettini., Eds.), p. 205-220, Springer - Verlag,. 1999.

Venograms (3T)

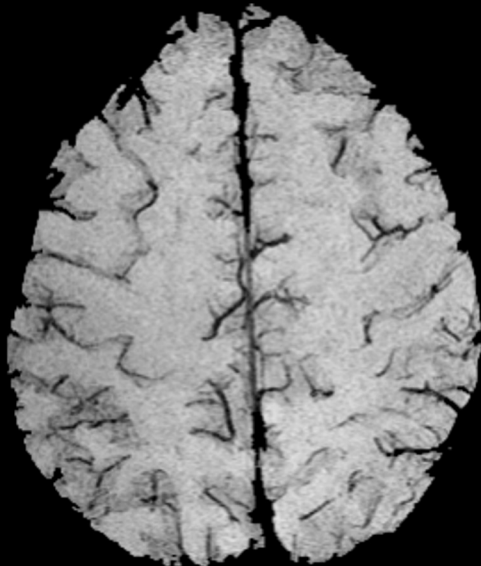
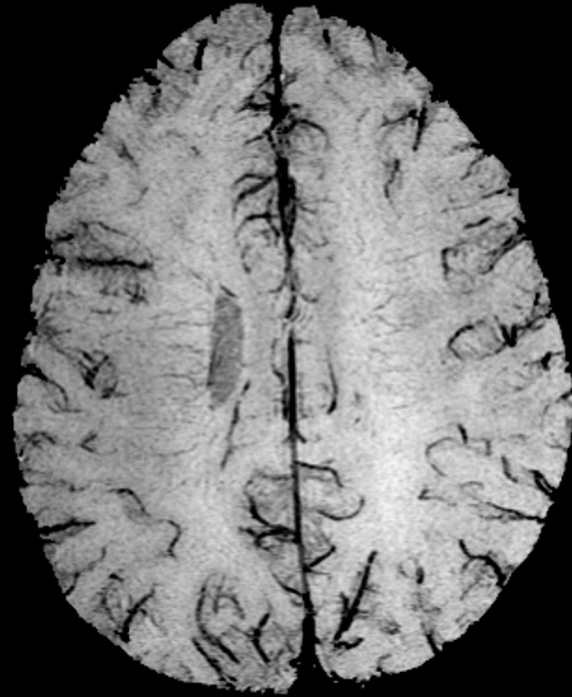

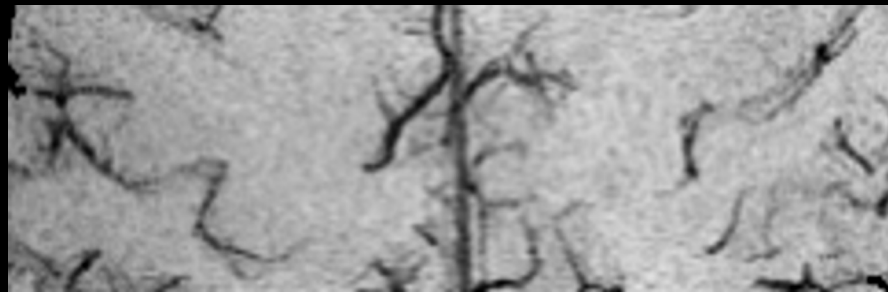
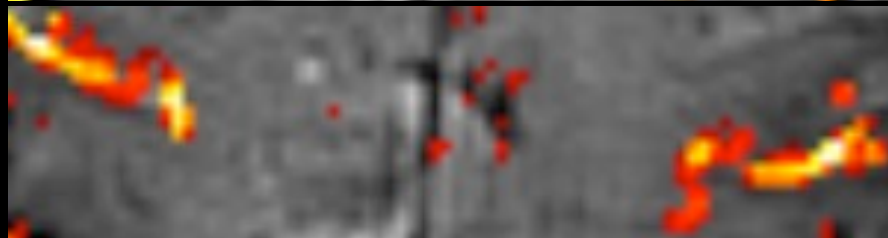
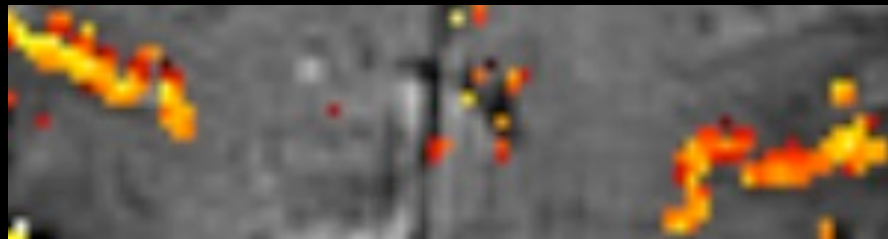
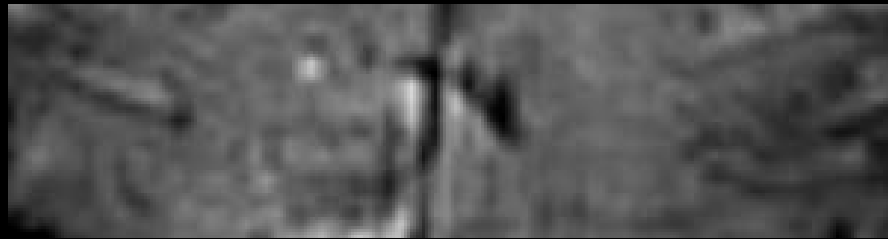

Hemi-Field Experiment

Left Hemisphere

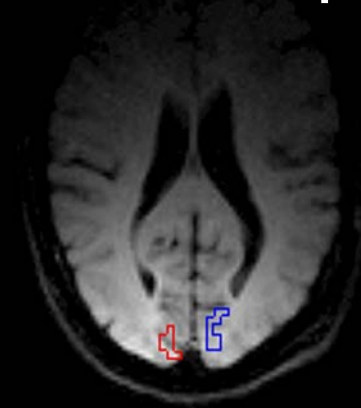

Right Hemisphere

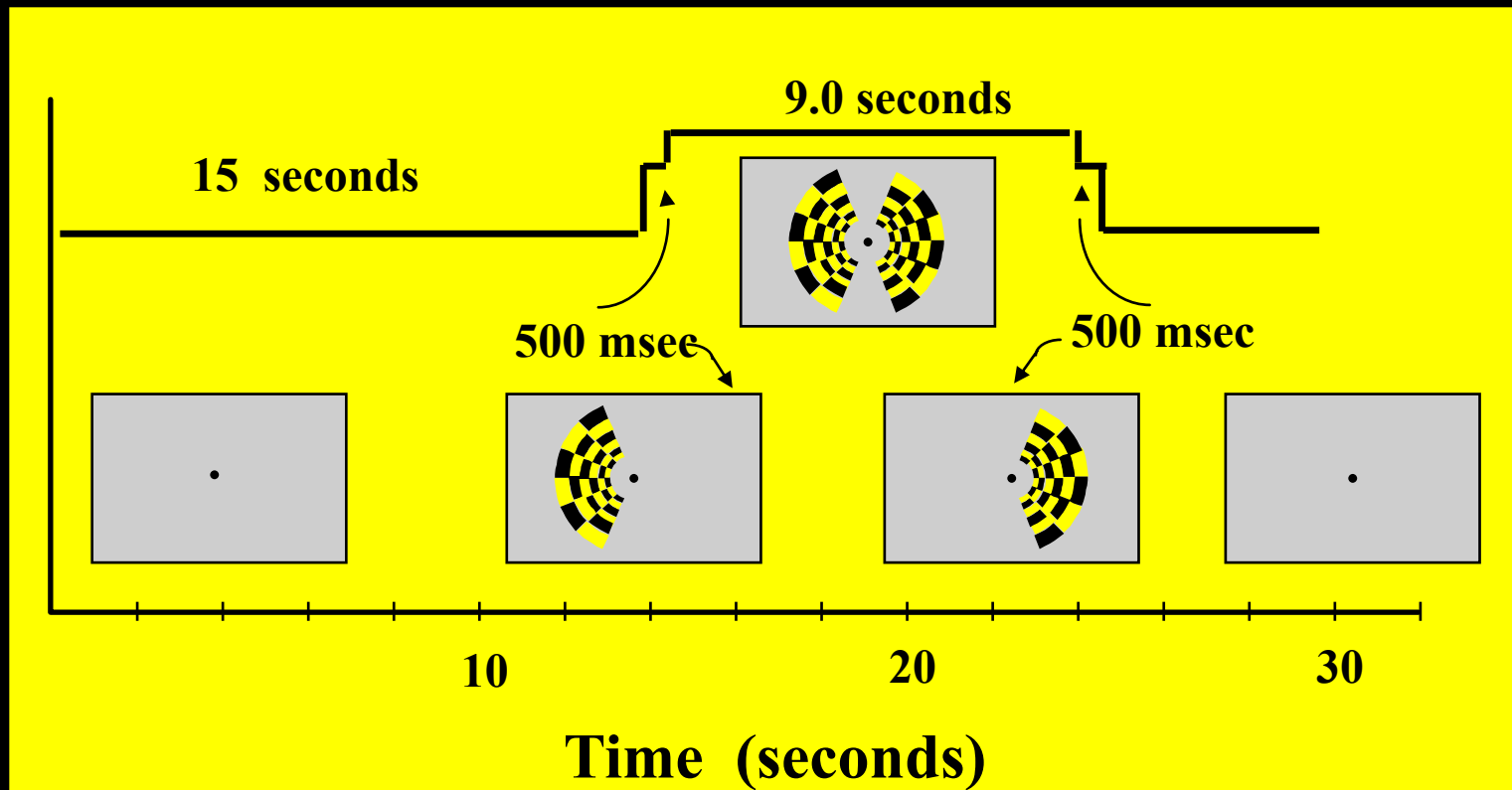

Calibration Techniques.....

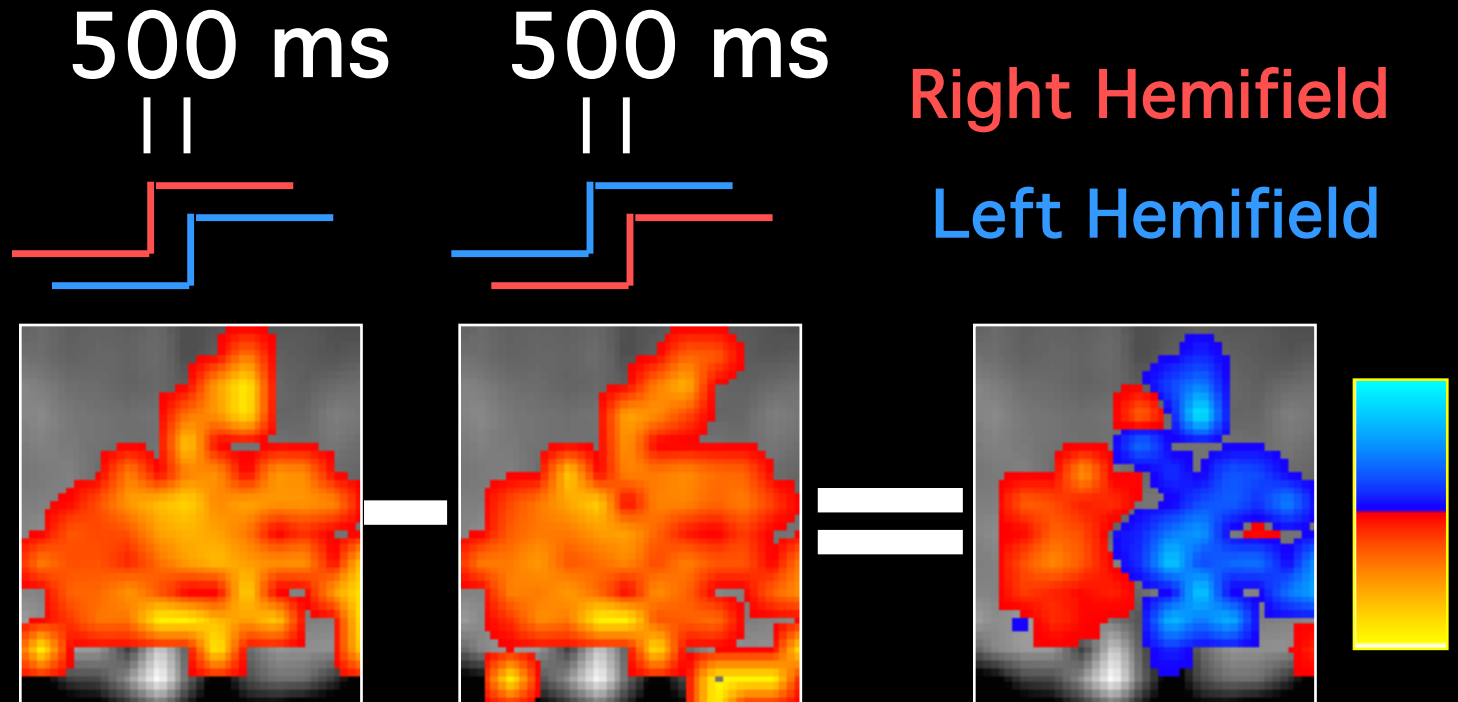
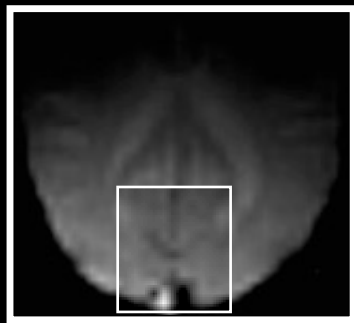

P. A. Bandettini, The temporal resolution of Functional MRI *in* "Functional MRI" (C. Moonen, and P. Bandettini., Eds.), p. 205-220, Springer - Verlag, 1999.



Lexical Delay

	Words	Non-Words	Mean Reaction Time
Rotational Delay			
0°	smudge	dierts	823 ms
60°	frolc	cuhlos	891 ms
120°	slouch	gedmus	1446 ms
Mean Reaction Time	986 ms	1219 ms	

PURPOSE / METHODS

Imaging Method: Scanner – 3T TR - 1000 ms TE - 30 ms

Behavioral Method:

Stimuli – Six-letter english words and pronounceable non-words.
Each word or non-word was rotated either 0, 60, or 120 degrees

Task – Lexical Decision (word / non-word).

Dependent Measures – Percent Correct and Reaction Time.

Hypotheses :

1) Stimulus rotation of 120 degrees will result in:

- a) Longer Reaction Times**
- b) Wider IRF in Parietal Lobe**
- c) Delayed IRF onset in Left Inferior Frontal cortex**

2) Lexical discrimination will result in :

- a) Longer Reaction Times for non-words**
- b) Wider IRF in Inferior Frontal cortex for non-words**
- c) Delayed IRF onset in Left Middle Frontal Cortex**

Delay Differences from Individual Voxels within the Above ROI's

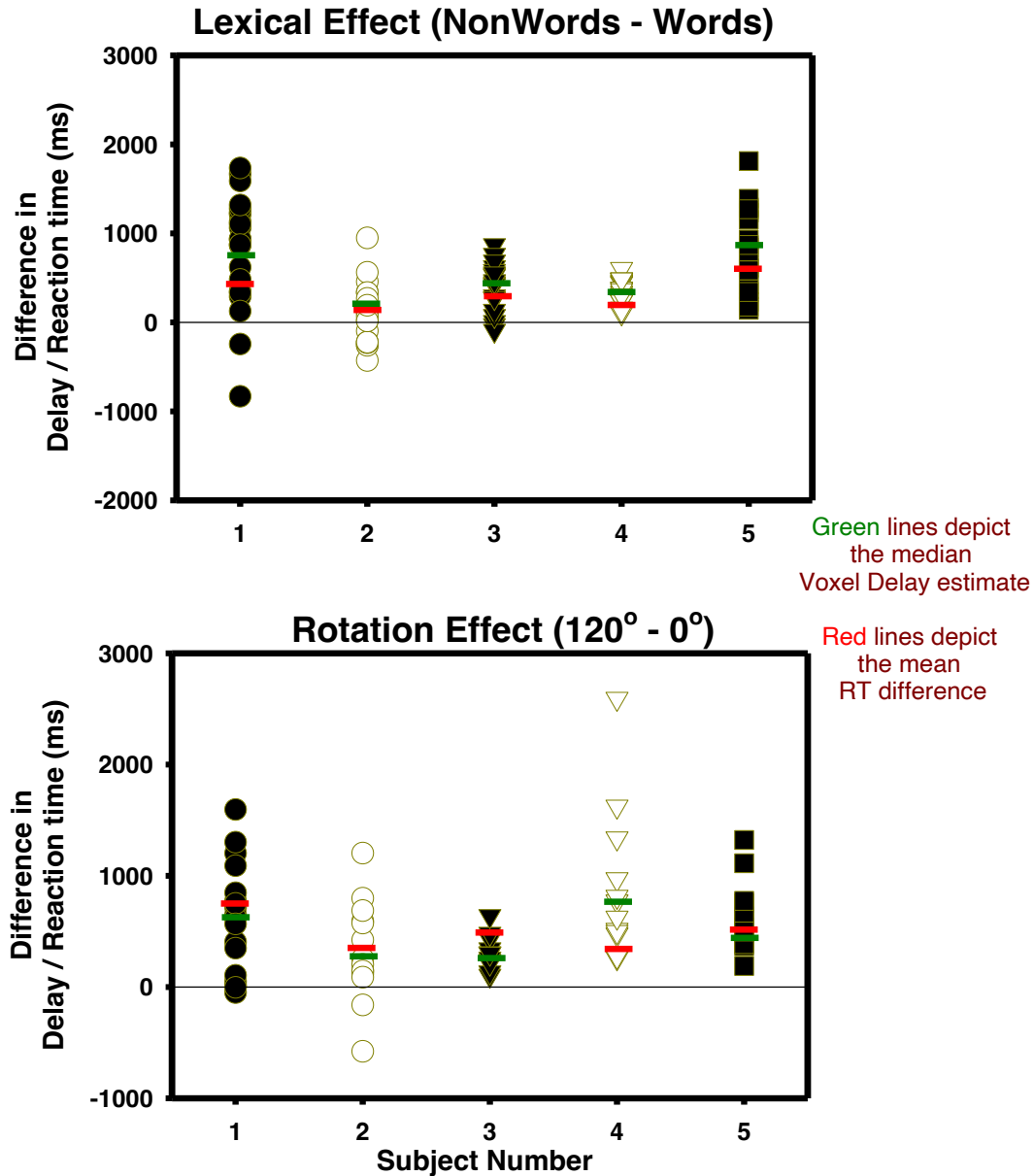

Response Times for each Stimulus Type

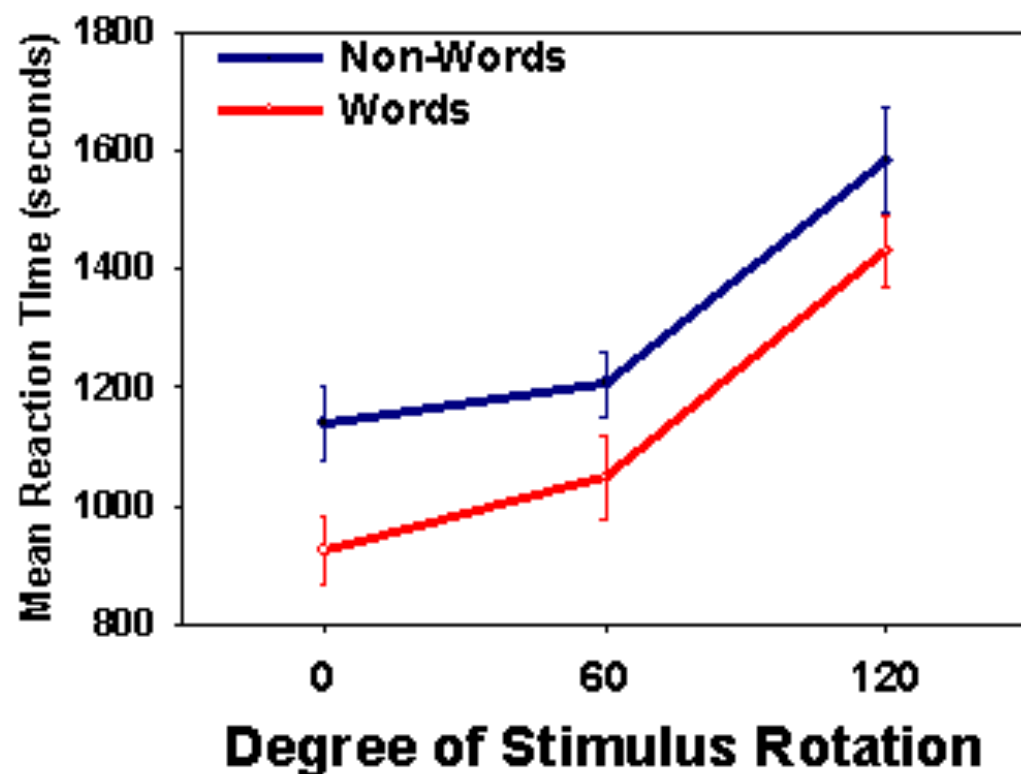

Lexical effect maps

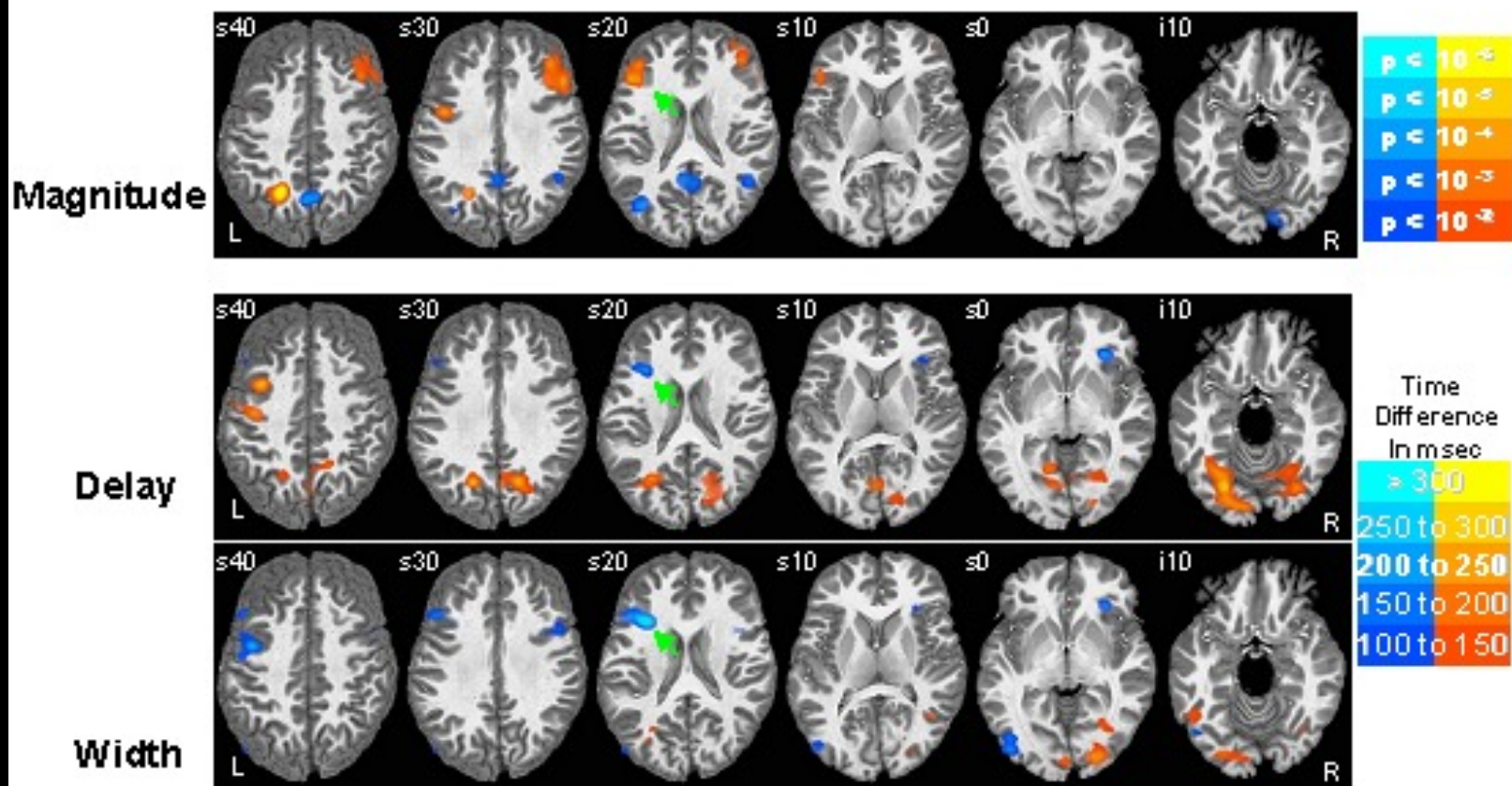
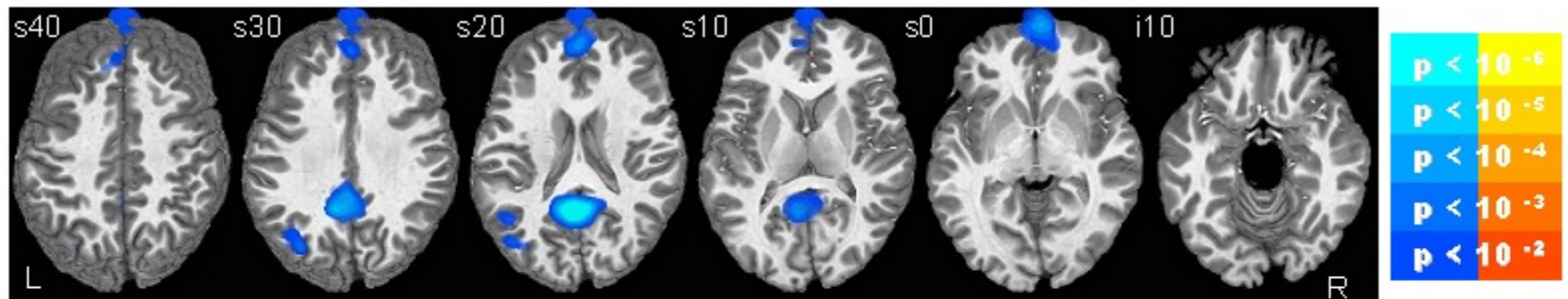
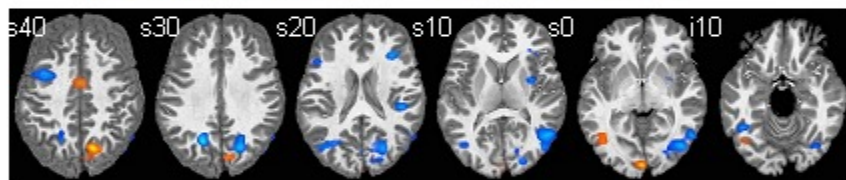

Figure 2. Warm colors are areas where *Words* > *Non-words*. Cool colors (blues) are areas where *Non-words* > *words*. The Left hemisphere is toward the left margin. The green arrows highlight the inferior frontal gyrus.

Rotational effect maps



Non-rotated vs. 120° rotated



Delay

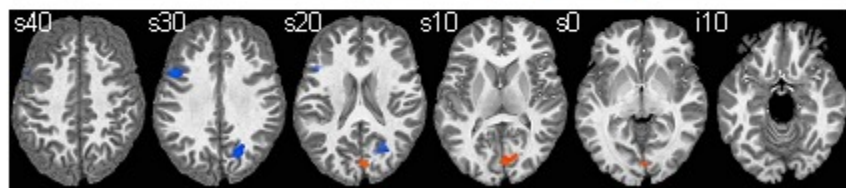

Width

Non-rotated vs. 60° rotated

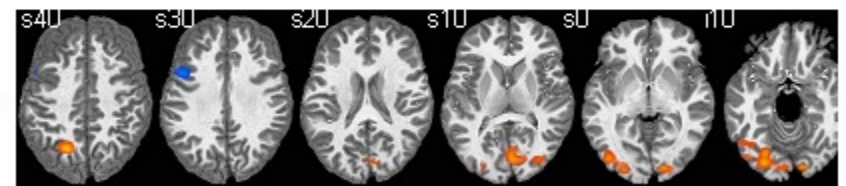

Figure 3. Warm colors are areas where Non-rotated stimuli > rotated. Cool colors (blues) are areas where Rotated stimuli > Non-rotated. The Left hemisphere is toward the left margin.

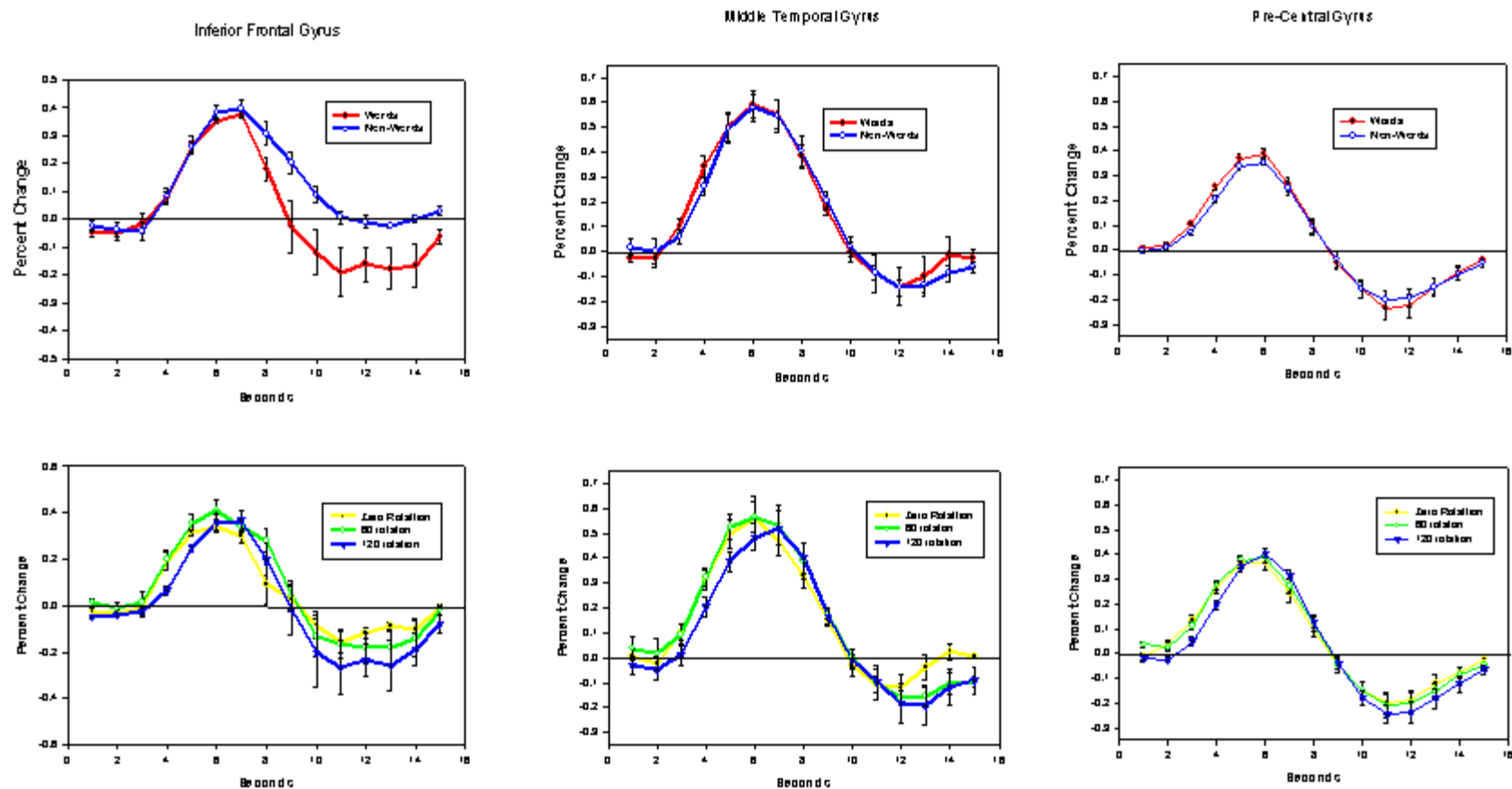
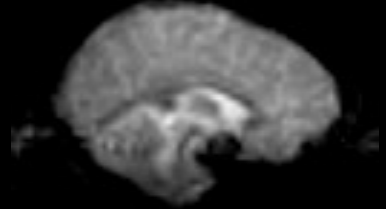
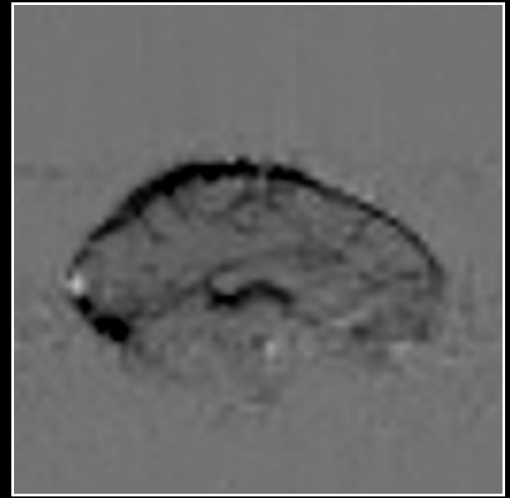
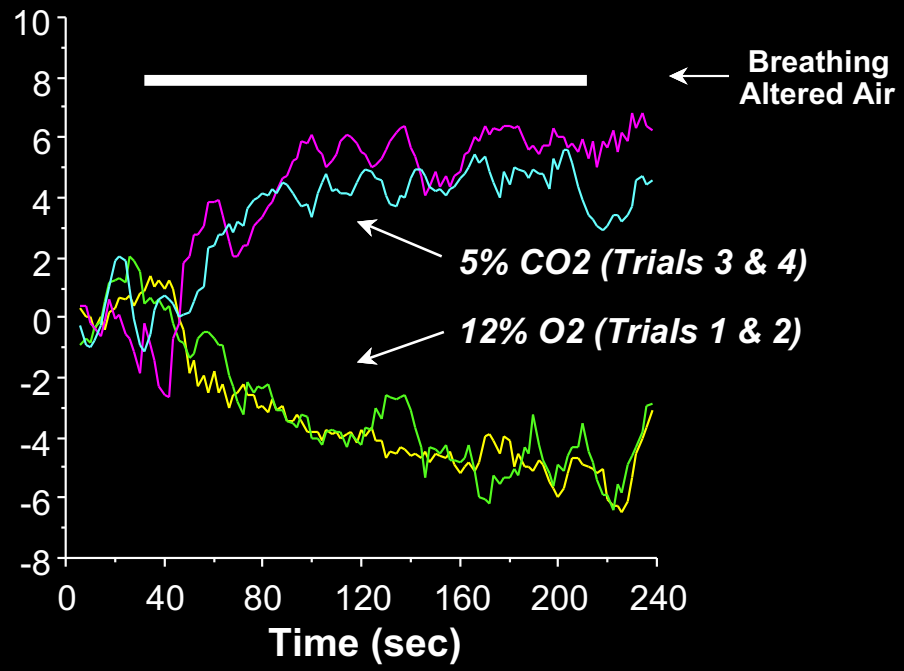
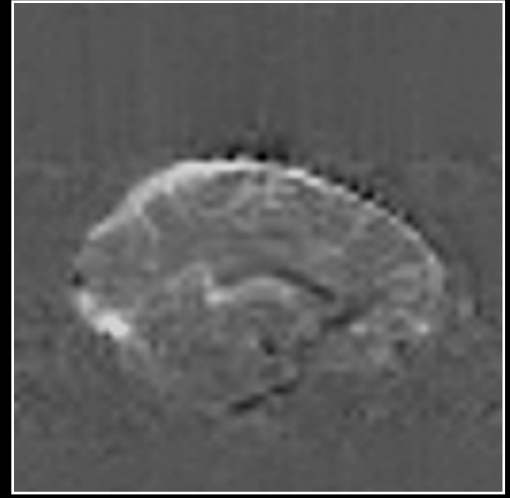

Figure 4. Graphs depicting the estimated Impulse Response Functions calculated by collapsing across all conditions. Error bars represent the standard error of the mean.



5% CO2



12% O2

Linear coupling between cerebral blood flow and oxygen consumption in activated human cortex

RICHARD D. HOGE^{*†}, JEFF ATKINSON^{*}, BRAD GILL^{*}, GÉRARD R. CRELIER^{*}, SEAN MARRETT[‡], AND G. BRUCE PIKE^{*}

^{*}Room WB325, McConnell Brain Imaging Centre, Montreal Neurological Institute, Quebec, Canada H3A 2B4; and [‡]Nuclear Magnetic Resonance Center, Massachusetts General Hospital, Building 149, 13th Street, Charlestown, MA 02129

CBF

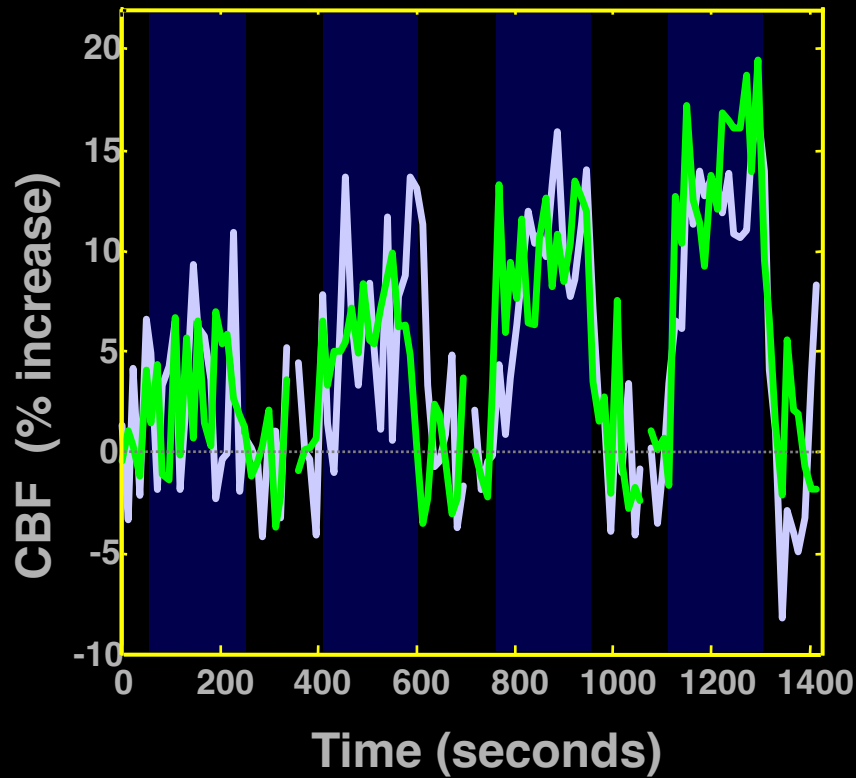

BOLD

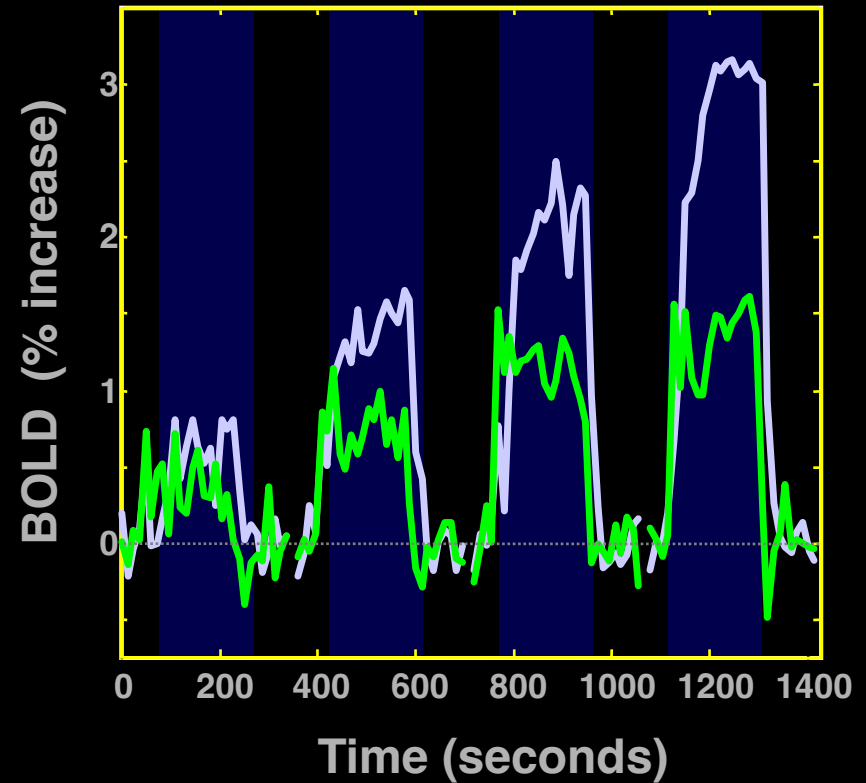

Simultaneous Perfusion and BOLD imaging during
graded visual activation and hypercapnia

N=12

Computed CMRO₂ Changes

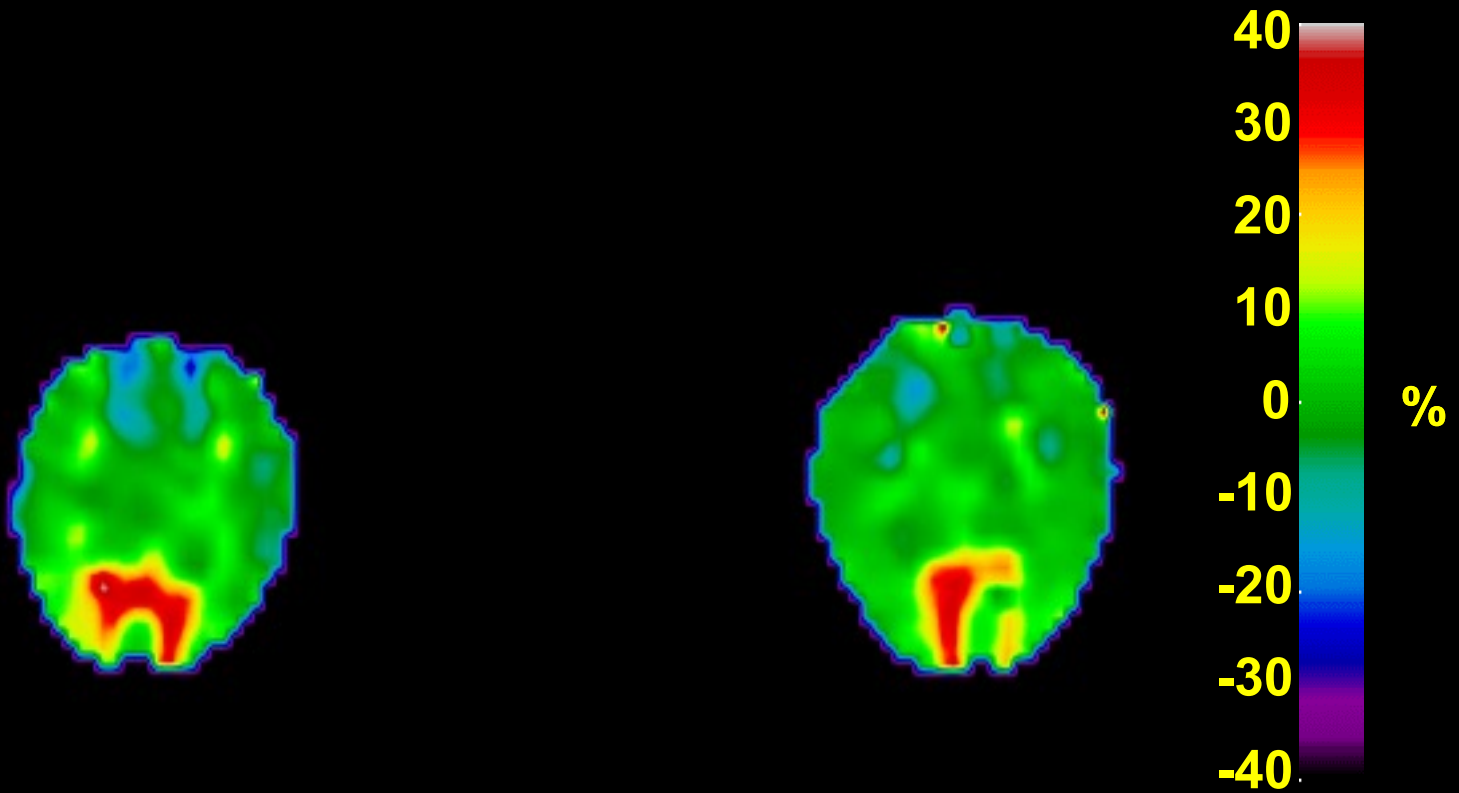

Subject 1

Subject 2

Quantitative measurements of cerebral metabolic rate of oxygen utilization using MRI: a volunteer study

Hongyu An,¹ Weili Lin,^{2*} Azim Celik³ and Yueh Z. Lee²

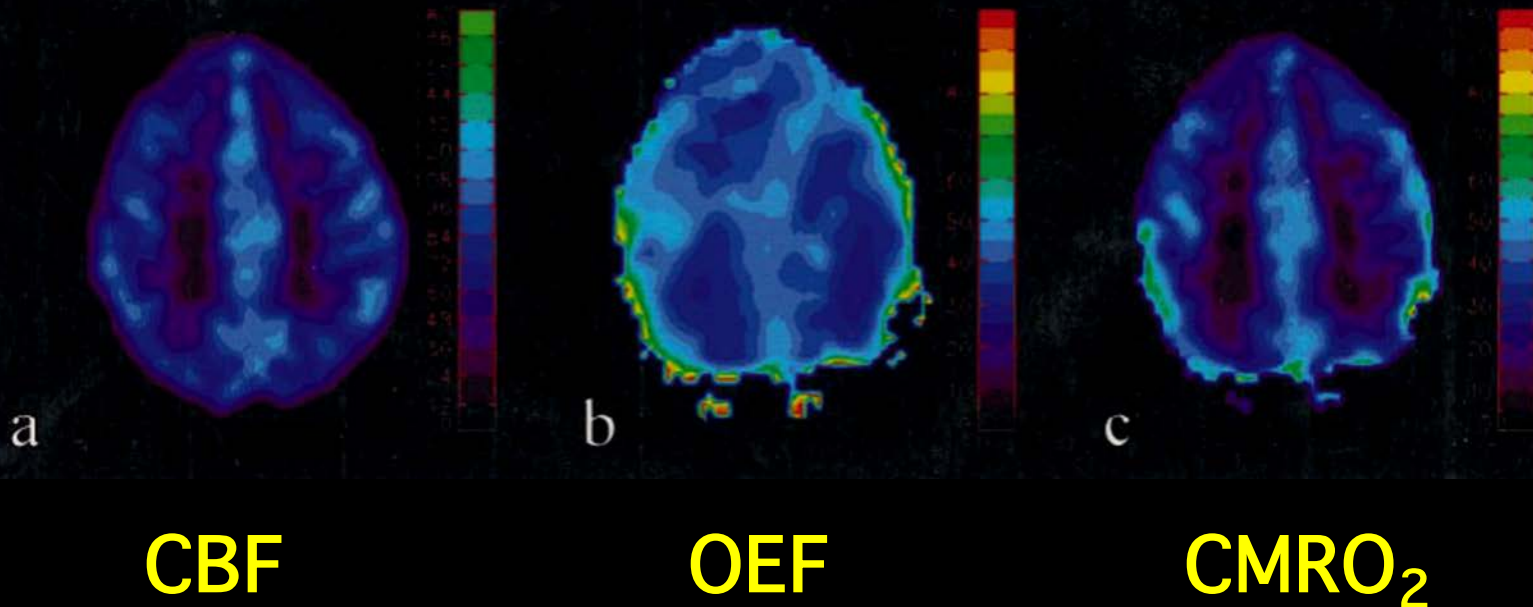

An approach to probe some neural systems interaction by functional MRI at neural time scale down to milliseconds

Seiji Ogawa^{††}, Tso-Ming Lee[†], Ray Stepnoski[†], Wei Chen[§], Xiao-Hong Zhu[§], and Kamil Ugurbil[§]

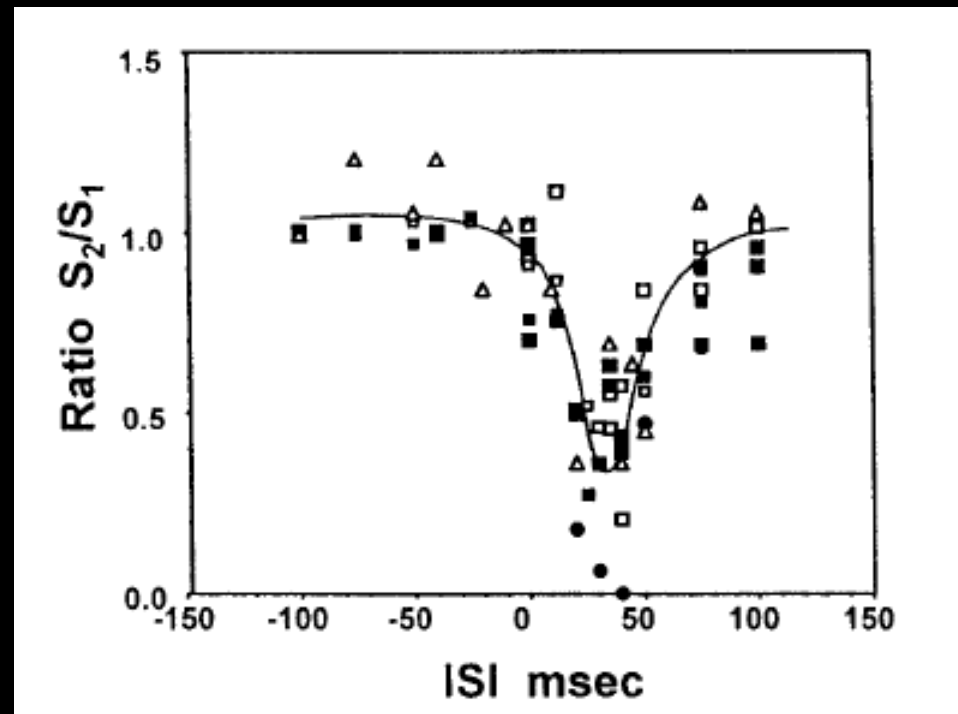

Future....

- Shimming
- Acoustic Noise
- Multishot Techniques
- Increased Gradient Performance
- Higher Field Strengths
- Surface Coil Arrays
- Calibration / Quantification
- Embedded Functional Contrast
- Noise / Fluctuations
- Direct Neuronal Current Imaging
- Clinical Populations
- Neuronal, Vascular, and Metabolic Information

Technology

MRI

EPI 1.5T,3T, 4T EPI on Clin. Syst. Diff. tensor Mg⁺ 7T

Local Human Head Gradient Coils Nav. pulses **Real time fMRI** Venography SENSE

ASL Spiral EPI Quant. ASL Dynamic IV volume Z-shim Baseline Susceptibility

BOLD Multi-shot fMRI Simultaneous ASL and BOLD **Current Imaging?**

Methodology

Baseline Volume

IVIM

Correlation Analysis Motion Correction CO₂ Calibration

Parametric Design Surface Mapping Multi-Modal Mapping

Phase Mapping Free-behavior Designs

Linear Regression Mental Chronometry

Event-related Deconvolution

Interpretation

Blood T2

Hemoglobin

BOLD models PET correlation

B₀ dep. IV vs EV ASL vs. BOLD

TE dep. Pre-undershoot PSF of BOLD

Resolution Dep. Extended Stim.

Post-undershoot Linearity Metab. Correlation

SE vs. GE CO₂ effect Fluctuations Optical Im. Correlation

NIRS Correlation Veins Inflow Balloon Model Electrophys. correlation

Applications

Complex motor Language Imagery Memory Emotion

Motor learning Children Tumor vasc. Drug effects

BOLD -V1, M1, A1 Presurgical Attention Ocular Dominance

Volume - Stroke V1, V2..mapping Priming/Learning Clinical Populations

Δ Volume-V1 Plasticity Face recognition Performance prediction

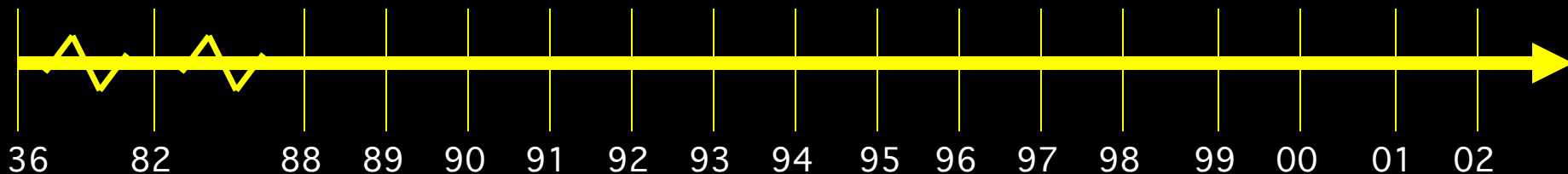

Processing Stream with Real Time fMRI

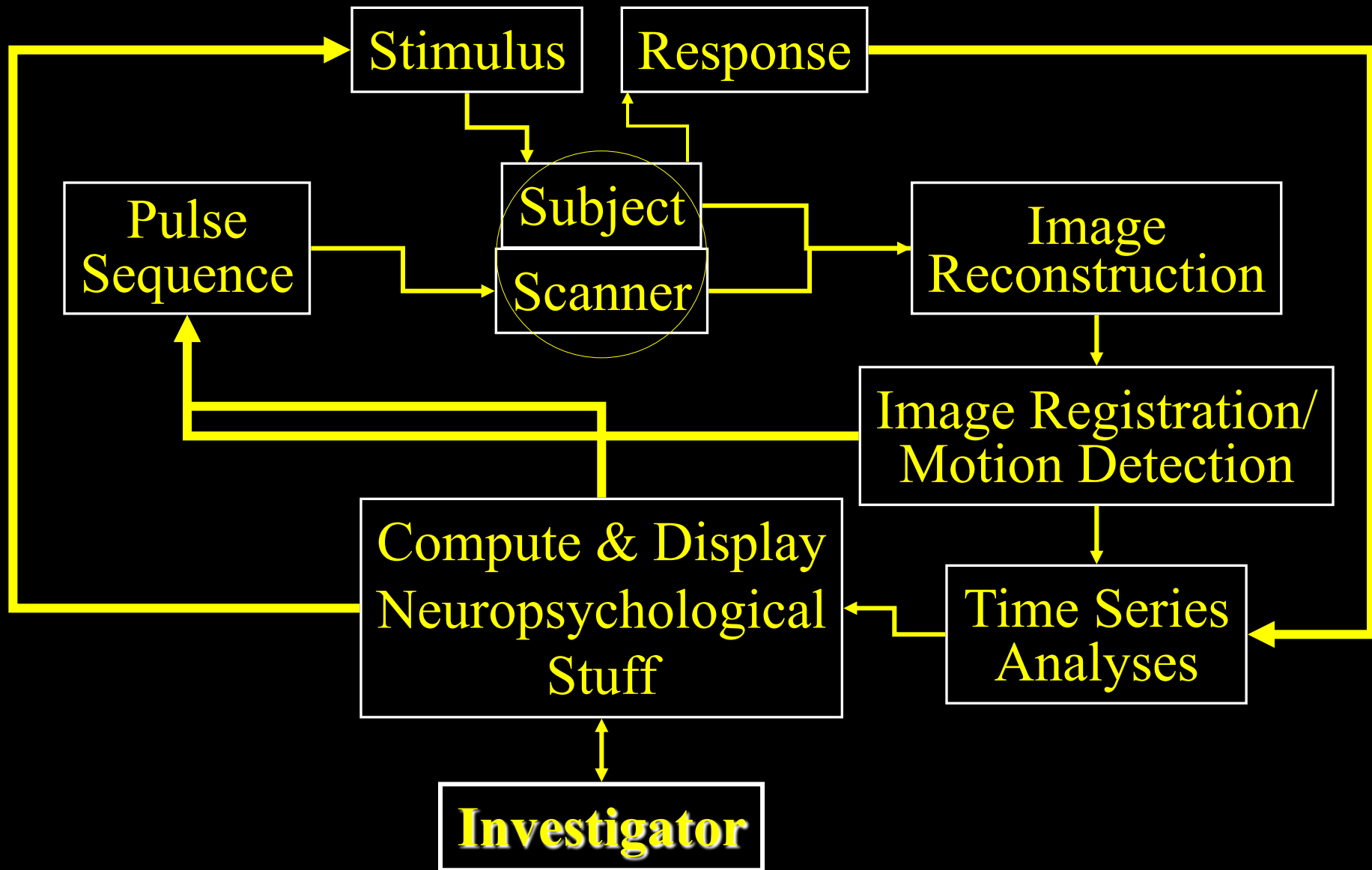

End of Acquisition

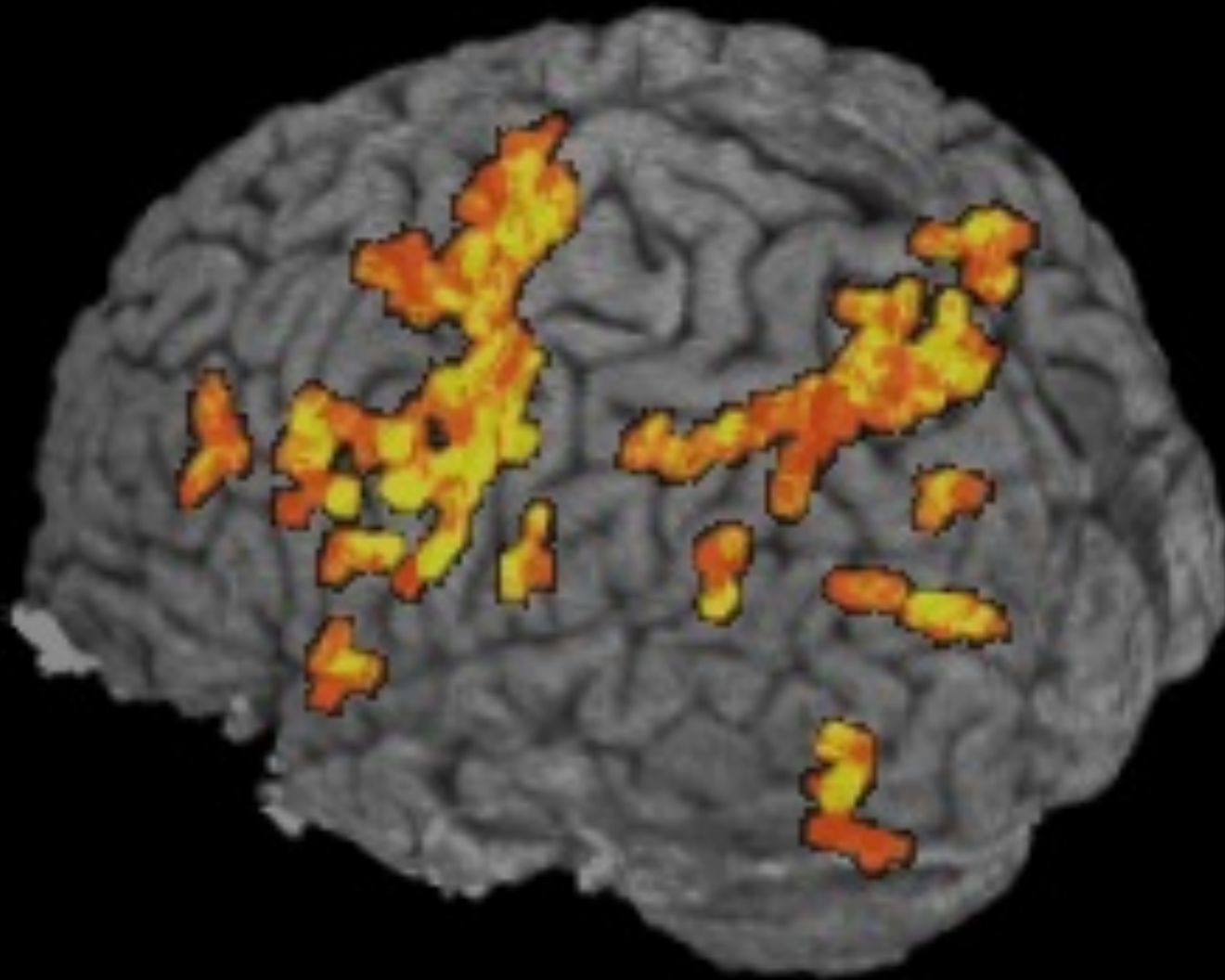

< 1 s to render

**Blocked trials:
20 s on/20 s off
8 blocks**

Blocks: 12345678

**Color shows
through brain**

Correlation > 0.45

**The
End**

2 G/cm, 350 T/m/s

4 G/cm, 150 T/m/s

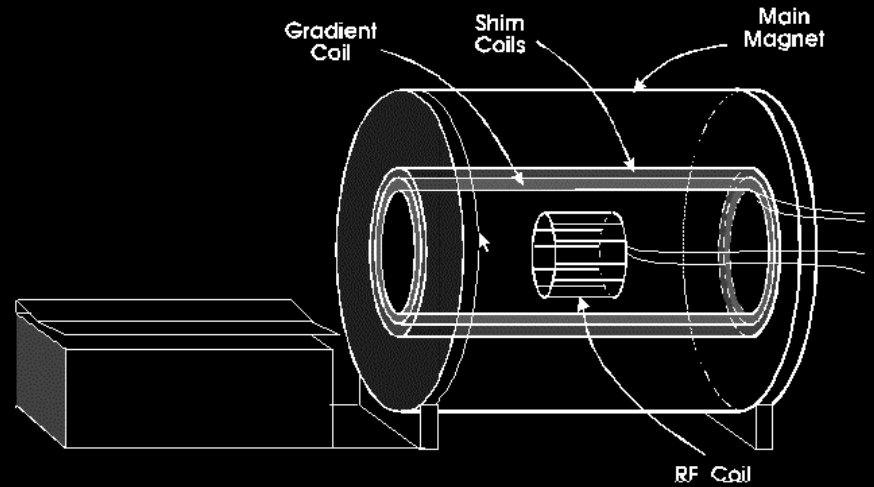

10 G/cm, 1000 T/m/s

Diffusion imaging
Faster imaging
Higher resolution

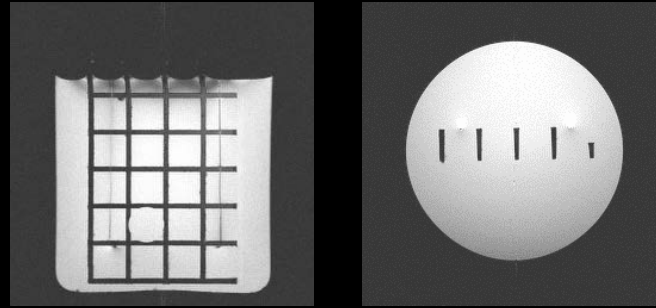

Neuronal Current Imaging

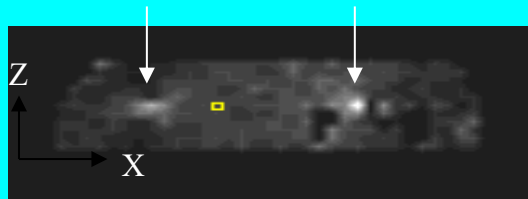
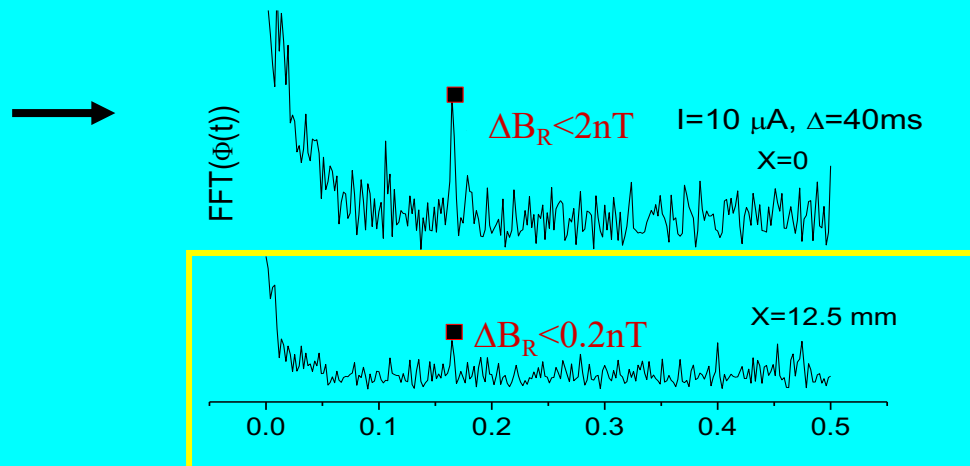

Figure 1



J. Bodurka, P. A. Bandettini. Toward direct mapping of neuronal activity: MRI detection of ultra weak transient magnetic field changes, *Magn. Reson. Med* 47: 1052-1058, (2002)

FIM Unit & FMRI Core Facility

Director:

Peter Bandettini

Staff Scientists:

Sean Marrett

Jerzy Bodurka

Frank Ye

Wen-Ming Luh

Computer Specialist:

Adam Thomas

Post Docs:

Rasmus Birn

Hauke Heekeren

David Knight

Patrick Bellgowan

Ziad Saad

Graduate Student:

Natalia Petridou

Post-Back. IRTA Students:

Elisa Kapler

August Tuan

Dan Kelley

Visiting Fellows:

Sergio Casciaro

Marta Maieron

Guosheng Ding

Clinical Fellow:

James Patterson

Psychologist:

Julie Frost

Summer Students:

Hannah Chang

Courtney Kemps

Douglass Ruff

Carla Wettig

Kang-Xing Jin

Program Assistant:

Kay Kuhns

Scanning Technologists:

Karen Bove-Bettis

Paula Rowser