

Functional Magnetic Resonance Imaging (fMRI)

-and a few other techniques

Peter A. Bandettini, Ph.D.
National Institutes of Health
bandettini@nih.gov



Two Types of Neuroimaging

- Structural/Anatomical Imaging
- Functional Imaging

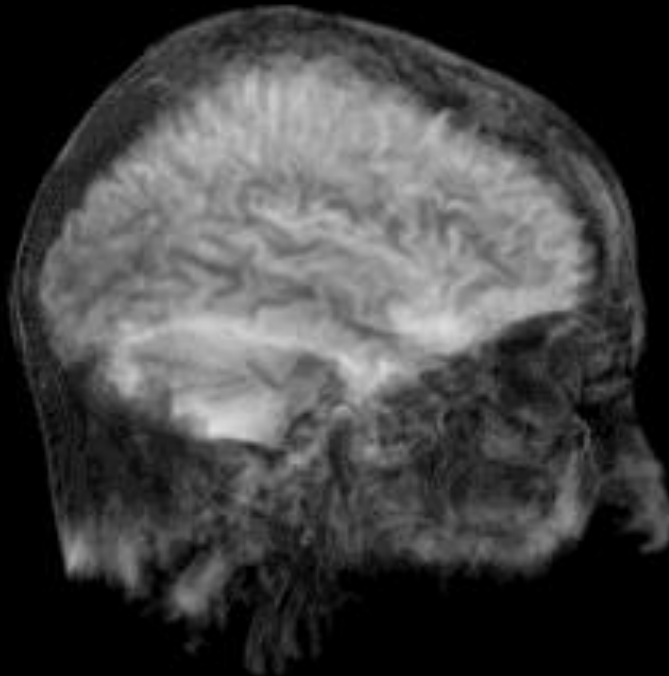

- **Structural/Anatomical Imaging**
 - X-ray
 - Computerized Tomography (CT)
 - Magnetic Resonance Imaging (MRI)
 - Angiography
 - Venography
 - Perfusion
 - Diffusion Tensor Imaging

Magnetic Resonance Imaging



Water: **42 MHz/Tesla**

1.5 Tesla = 63 MHz

3 Tesla = 126 MHz

7 Tesla = 294 MHz

Magnetic Resonance Imaging (MRI)

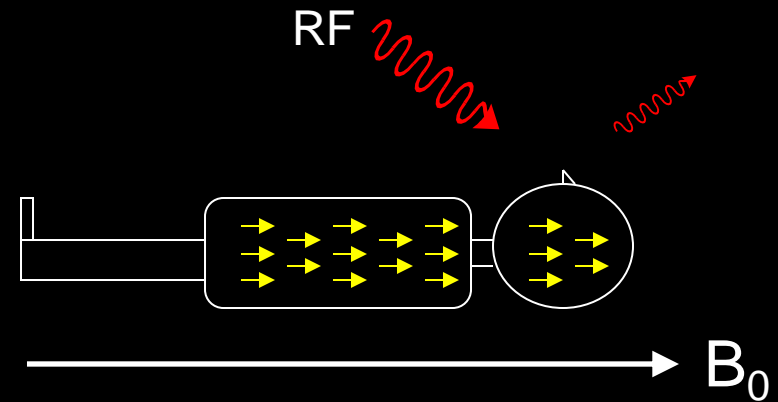
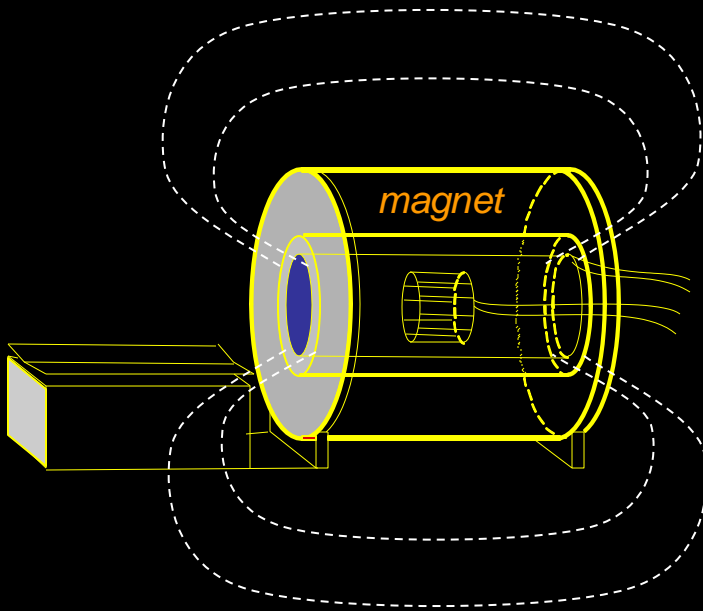

Sensitive to:

- # of protons (H_2O)
- Magnetic environment
 - Tissue structure

Magnetic Resonance Imaging

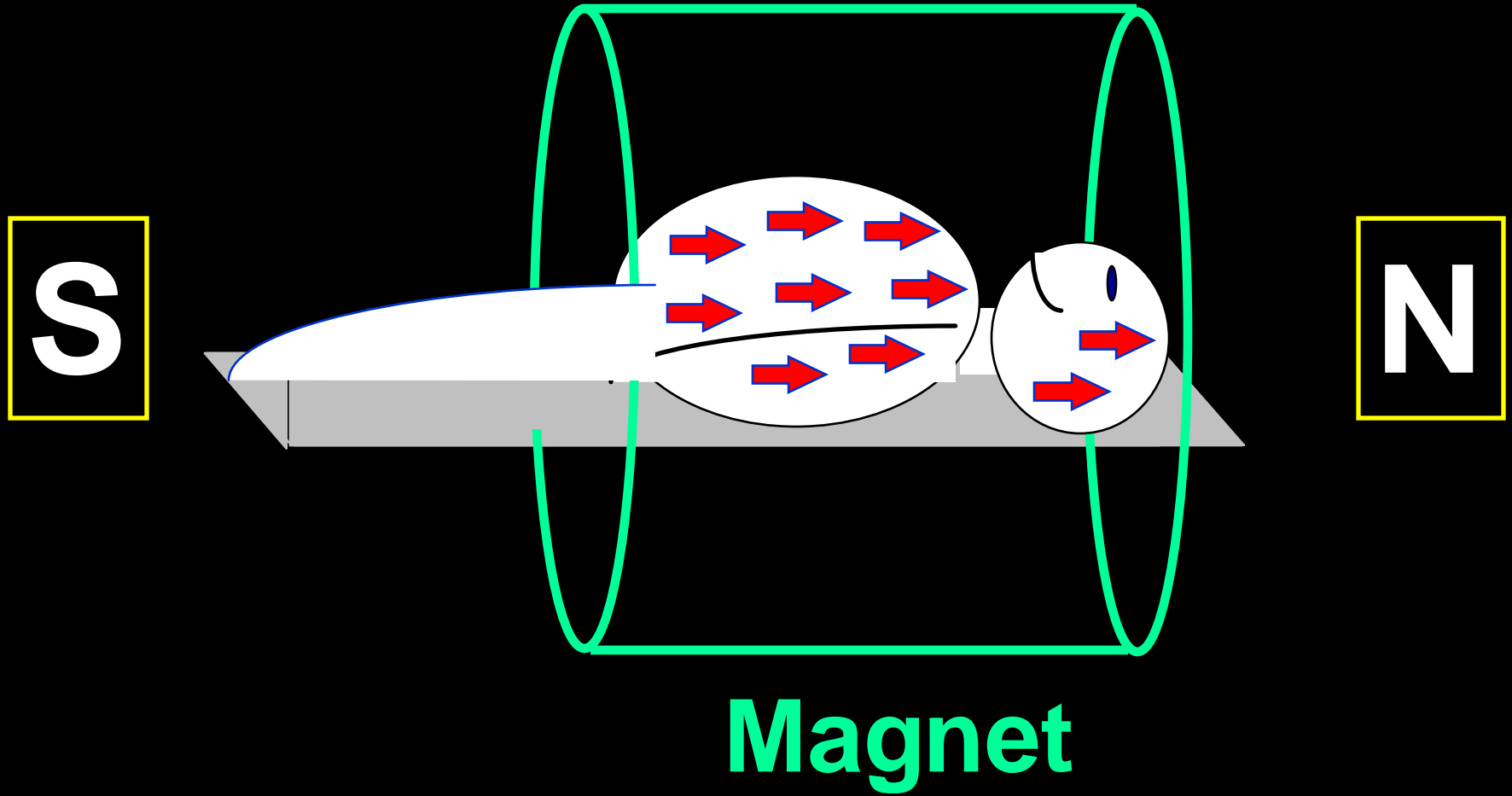

Magnetic Resonance Imaging

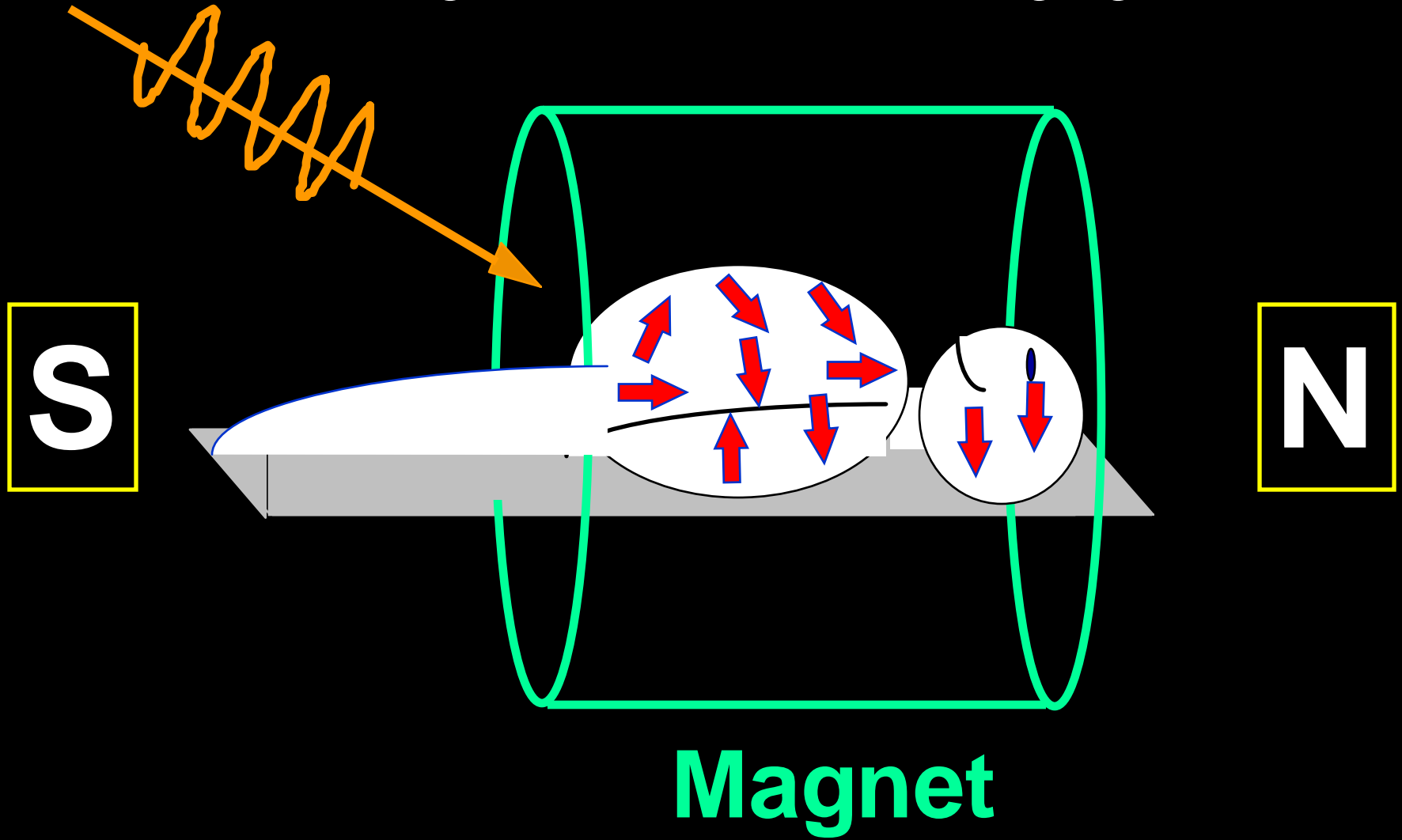



Magnetic Resonance Imaging

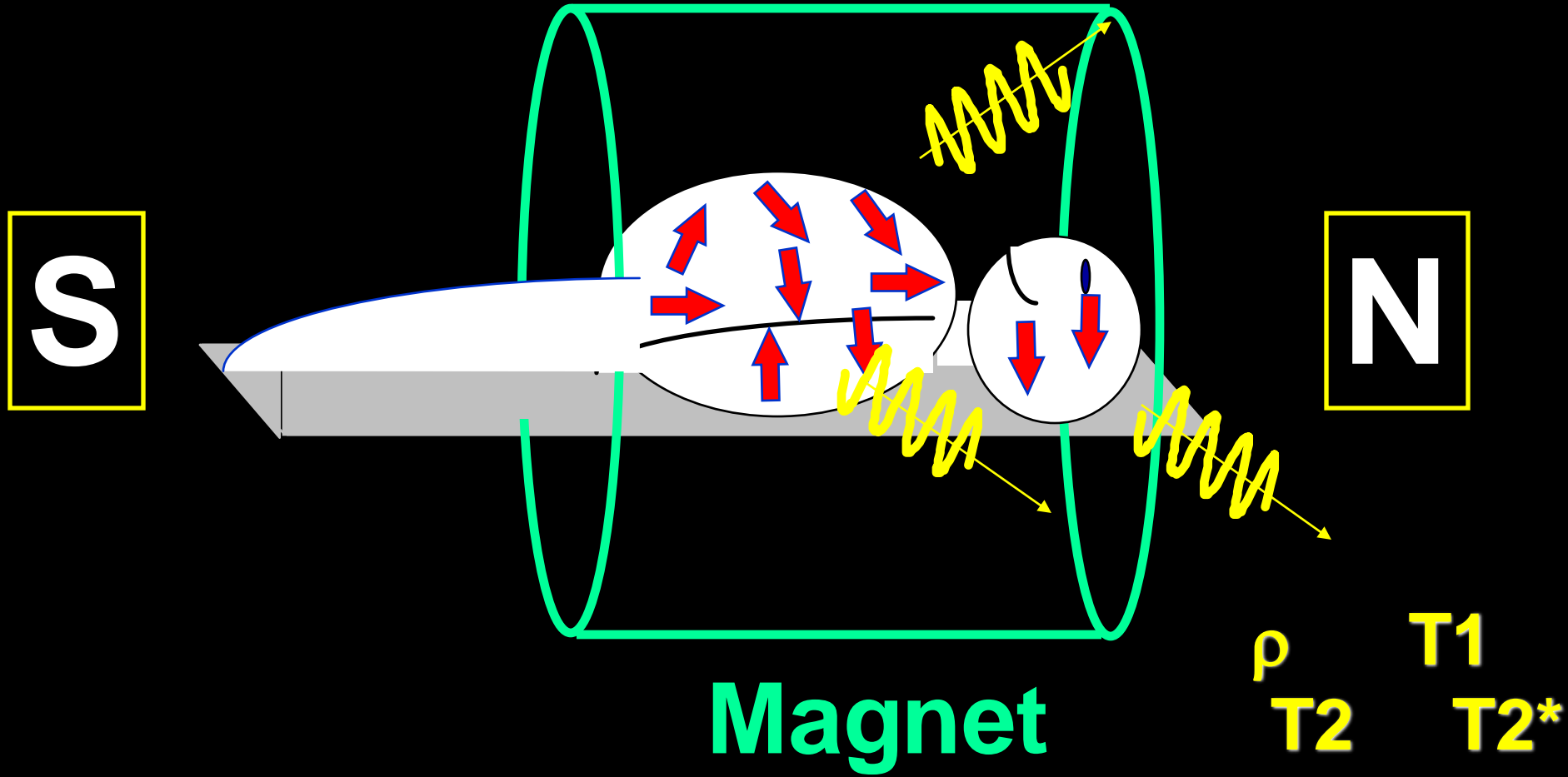

MRI Images with Different Contrast Weighting

T1 Weighted

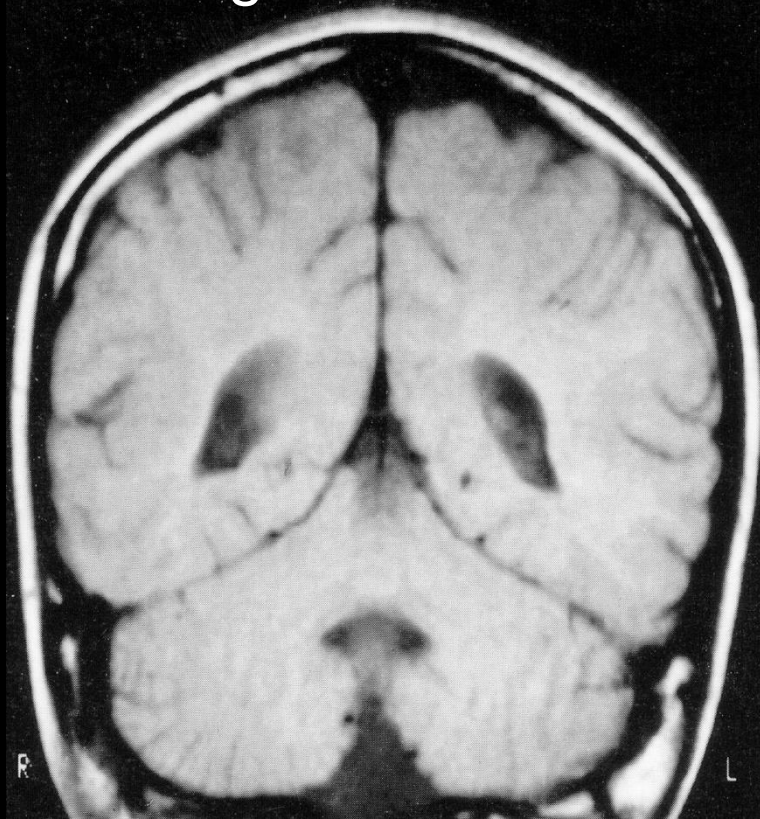

T2 Weighted

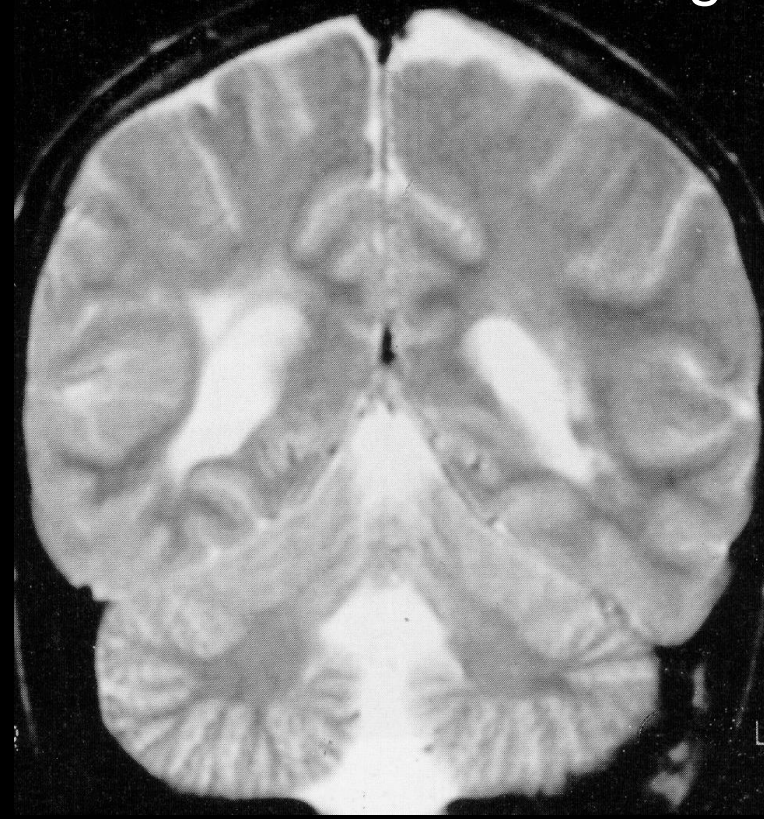

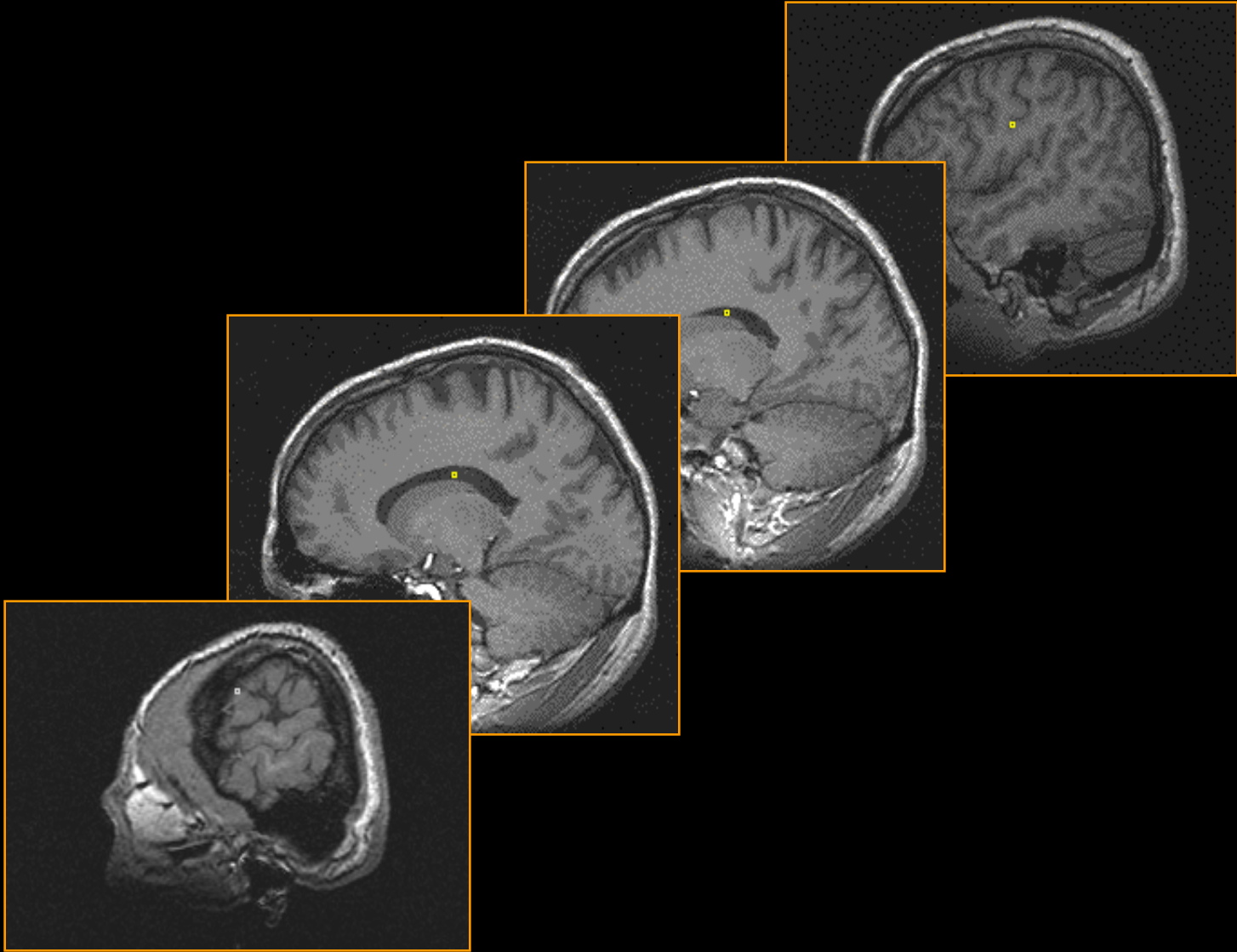

Fiber Track Imaging

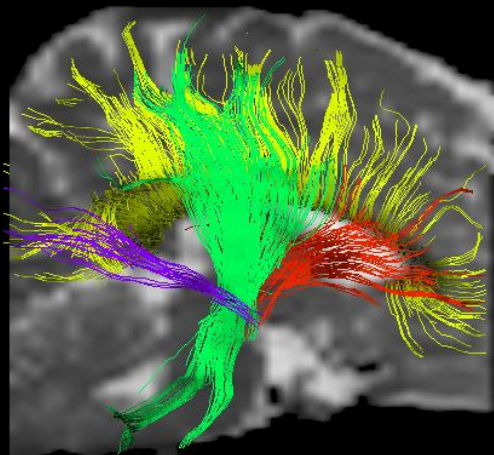

Venography

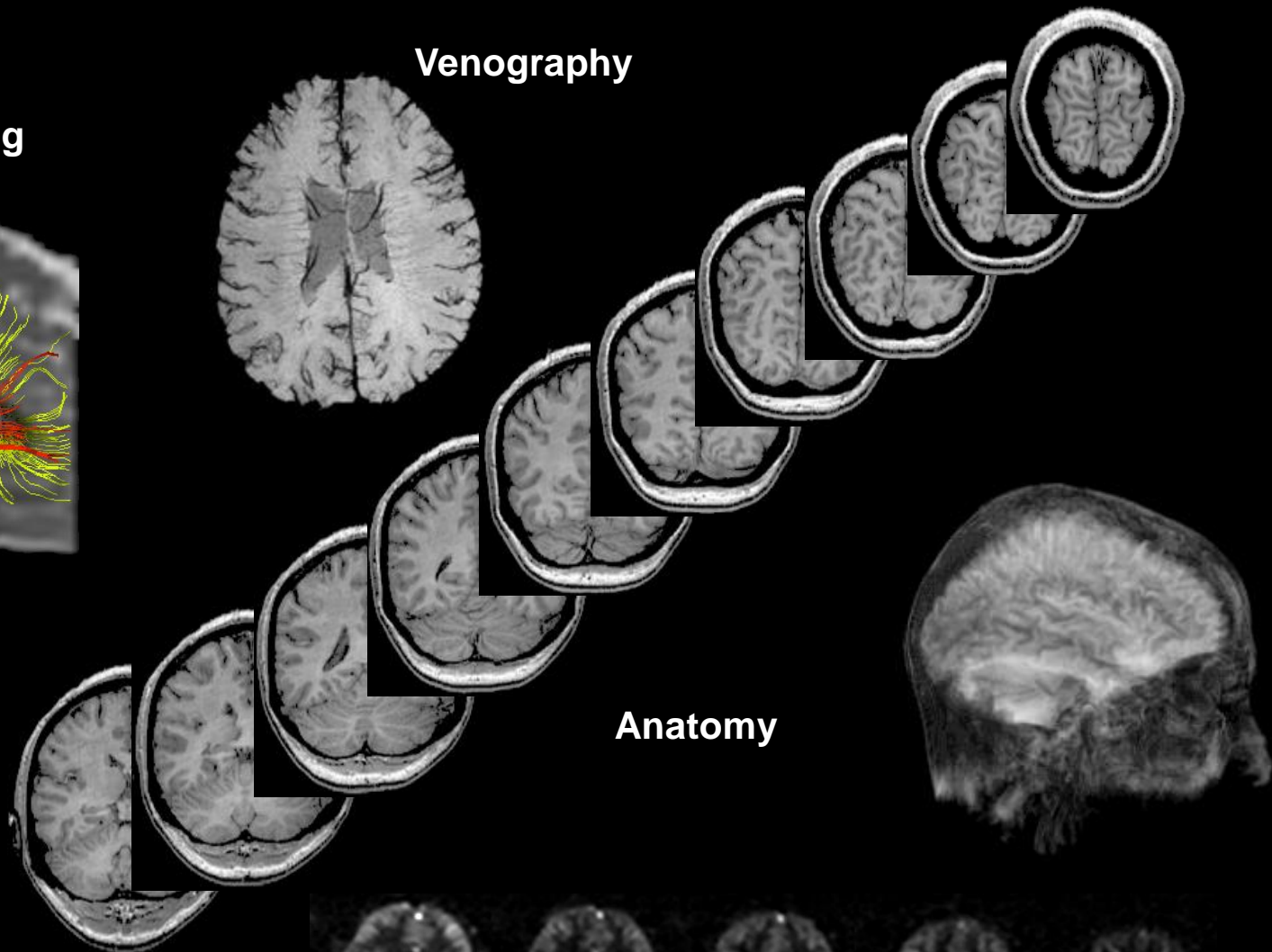
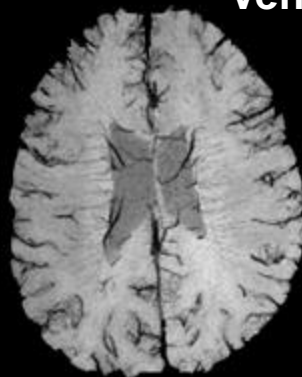

Anatomy

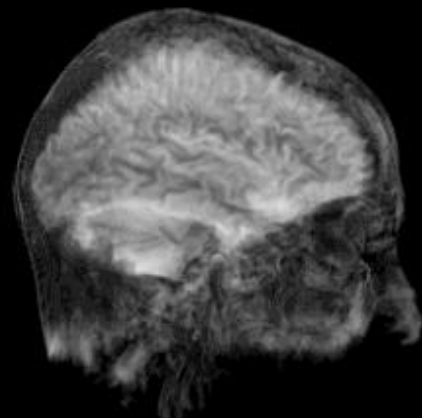

Angiography

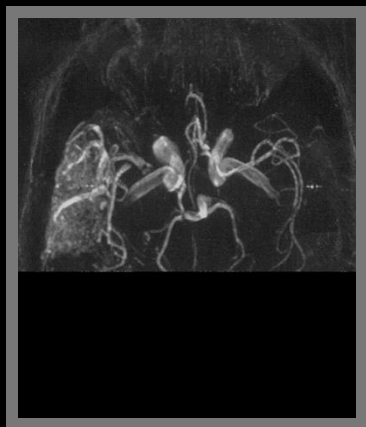

Perfusion

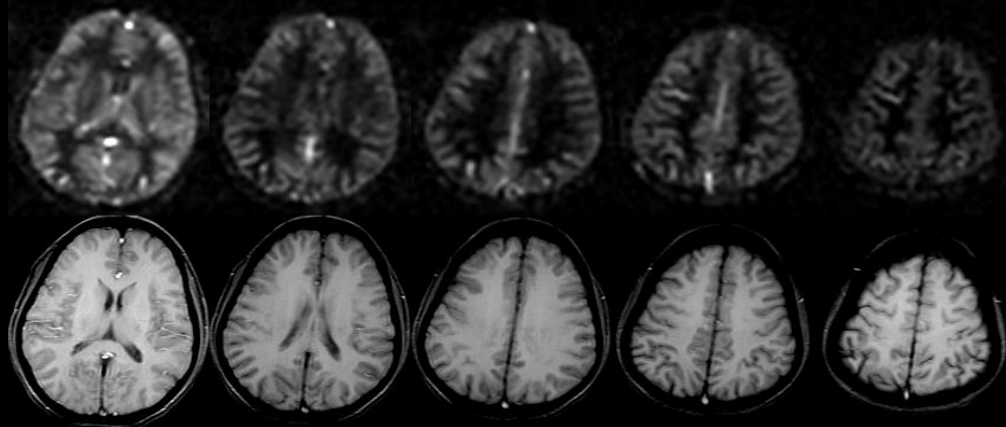

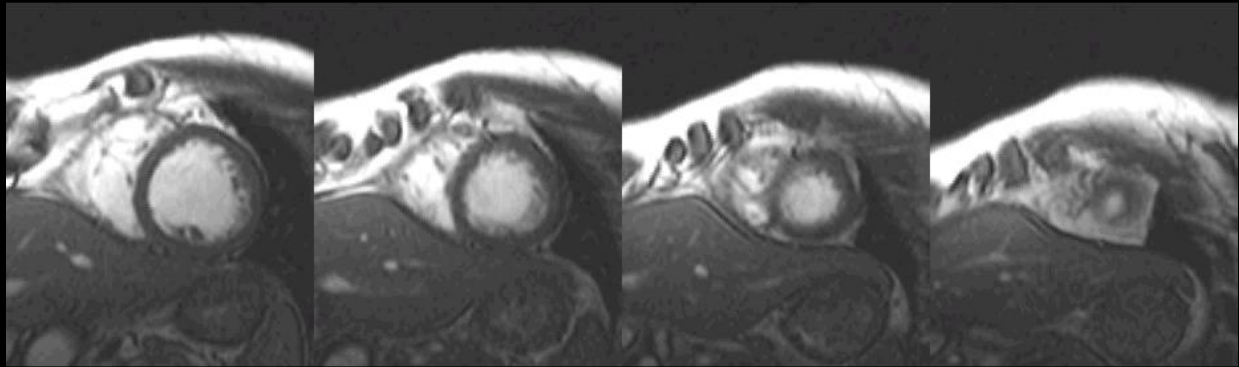
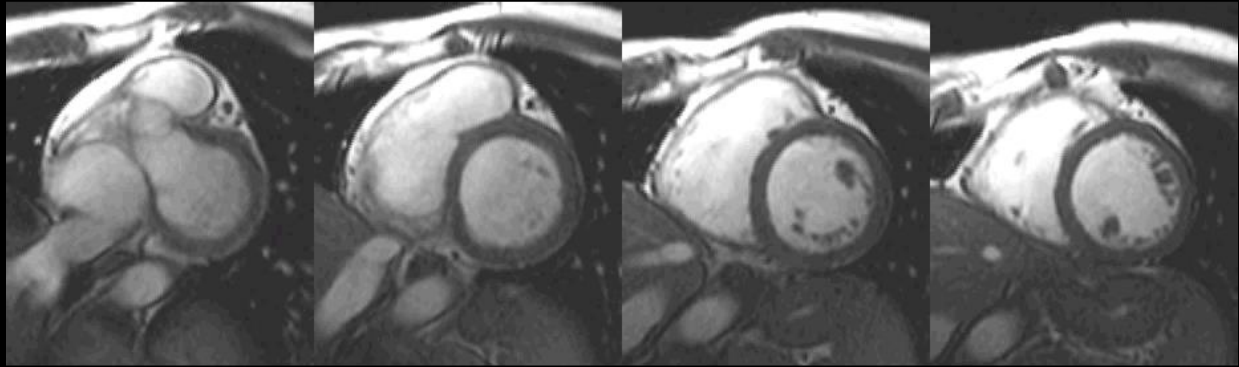
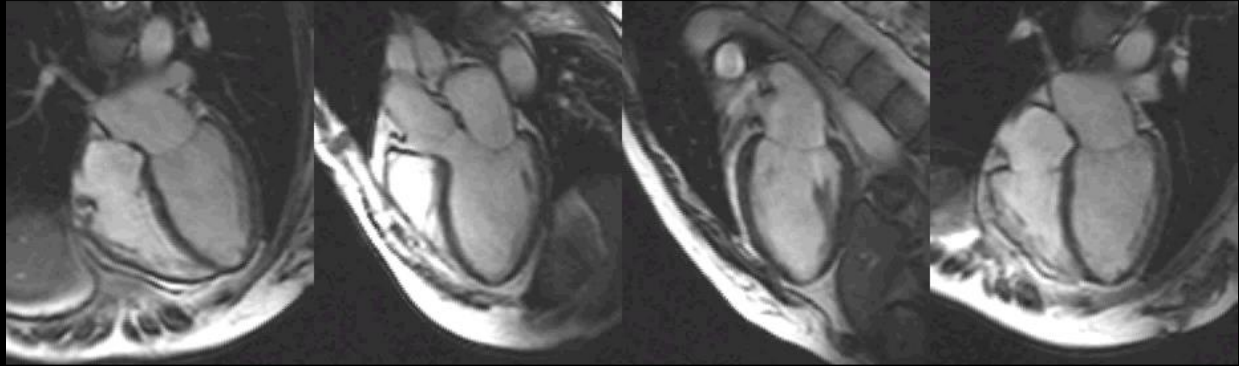

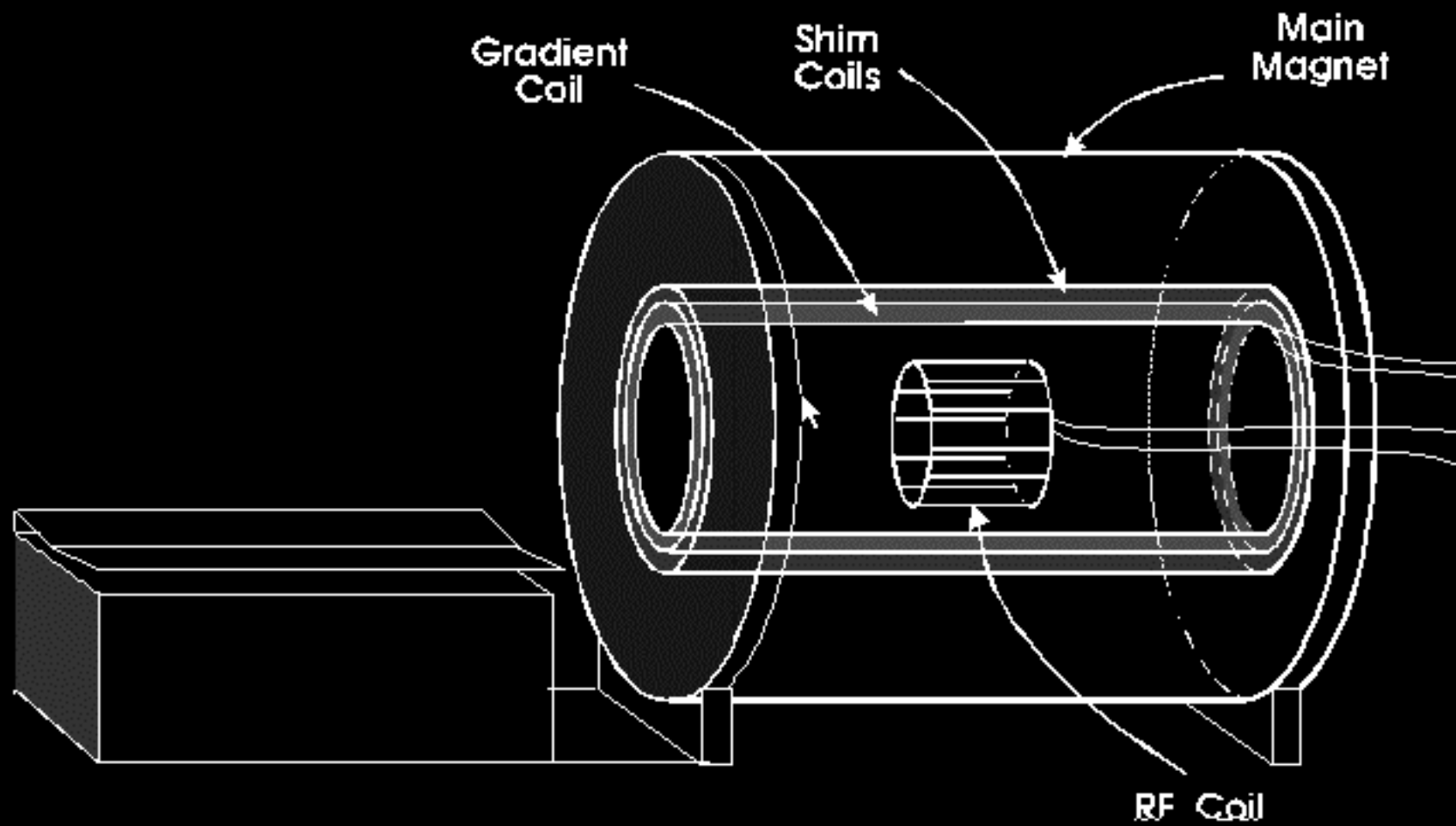





•Functional Imaging

- Xenon Computerized Tomography (Xe CT)
- Positron Emission Tomography (PET)
- Single Photon Computed Tomography (SPECT)
- Functional MRI (fMRI)
- Electroencephalography (EEG)
- Magnetoencephalography (MEG)
- Transcranial Magnetic Stimulation (TMS)

Functional Neuroimaging Techniques

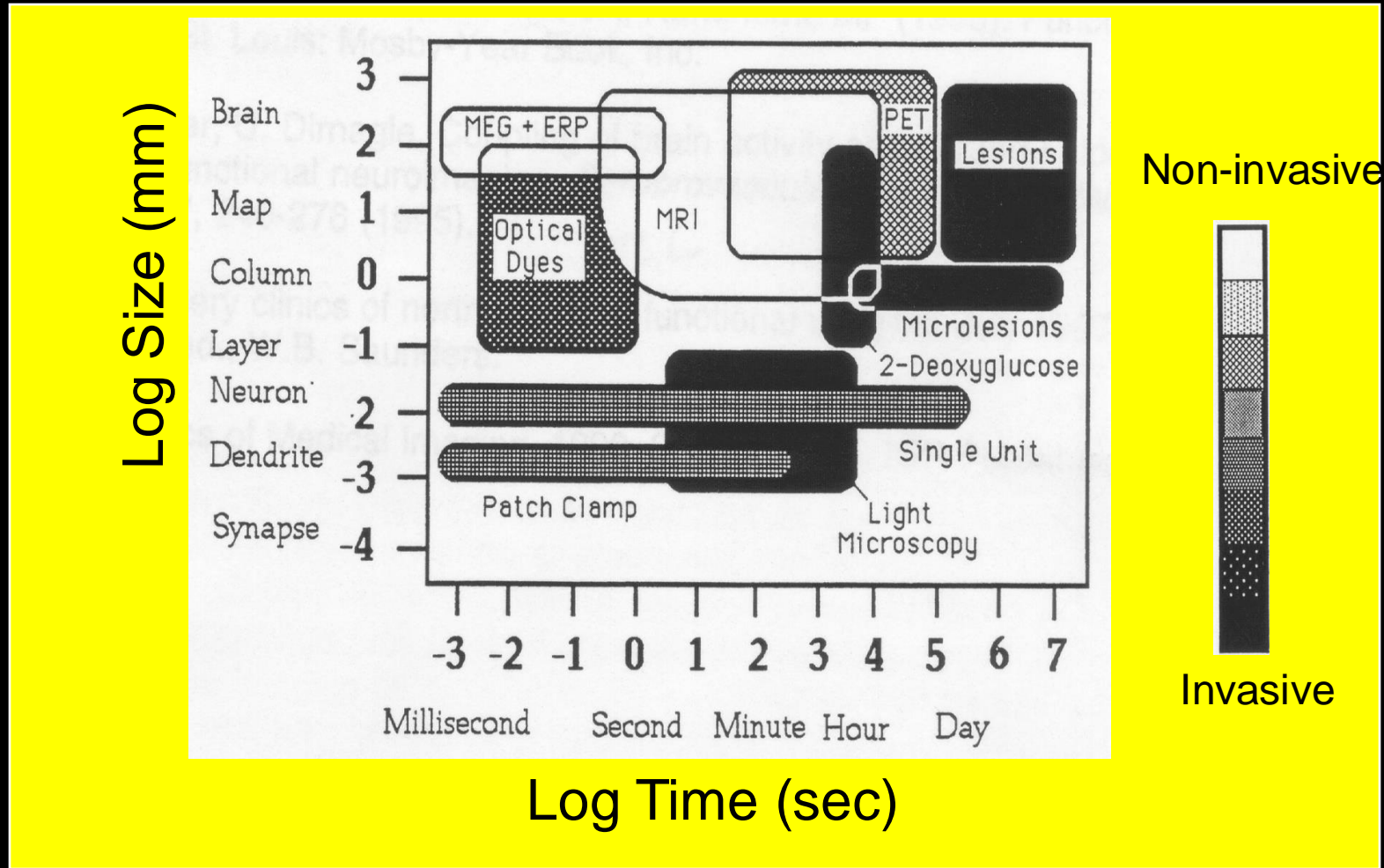

Positron Emission Tomography (PET)

- Positron emission tomography (PET) is a technique for studying functional processes *in vivo* by measuring the concentrations of positron-emitting radioisotopes within the subject.
- PET is primarily used to study biochemical and physiological processes within living organs.

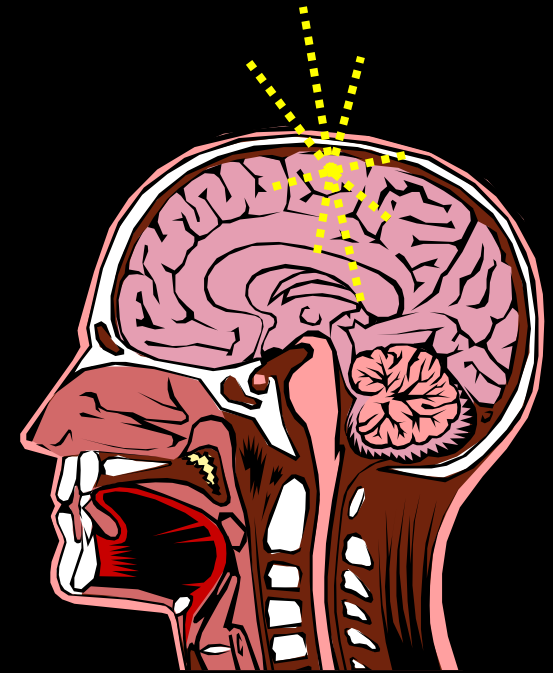

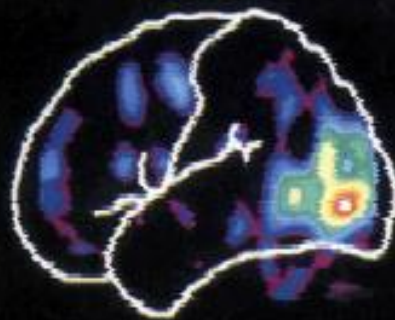

Passively viewing words

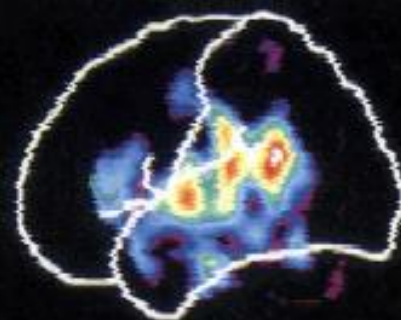

Listening to words

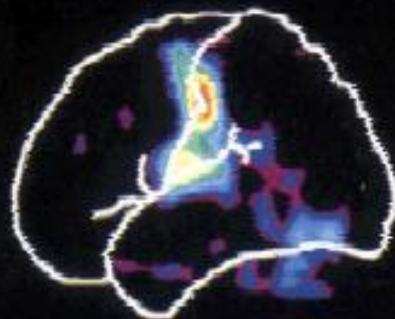

Speaking words

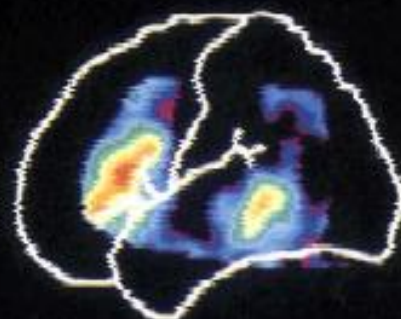

Generating verbs

Functional Magnetic Resonance Imaging

Functional Neuroimaging Techniques

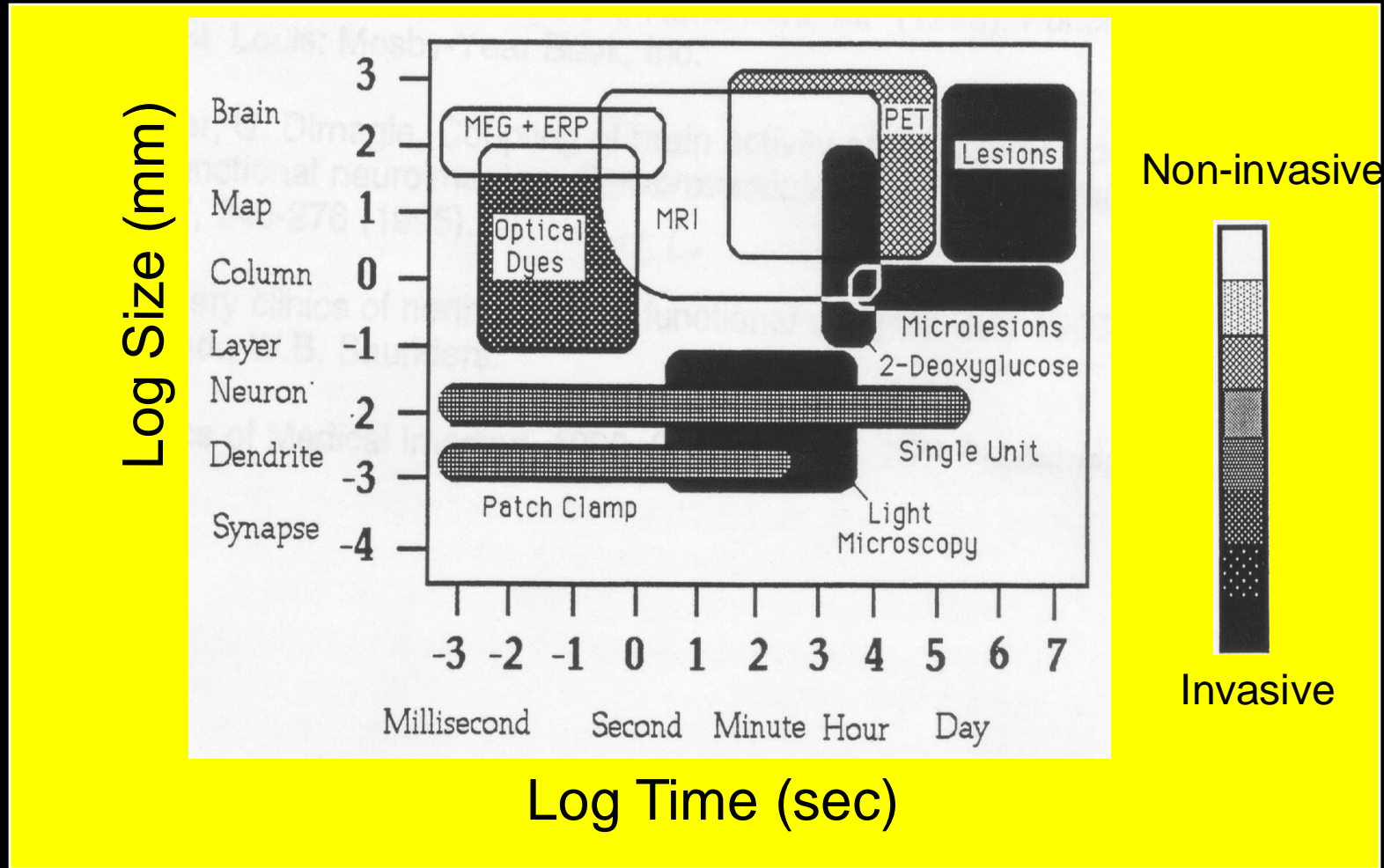

fMRI Setup



Courtesy, Robert Cox,
Scientific and Statistical
Computing Core Facility,
NIMH

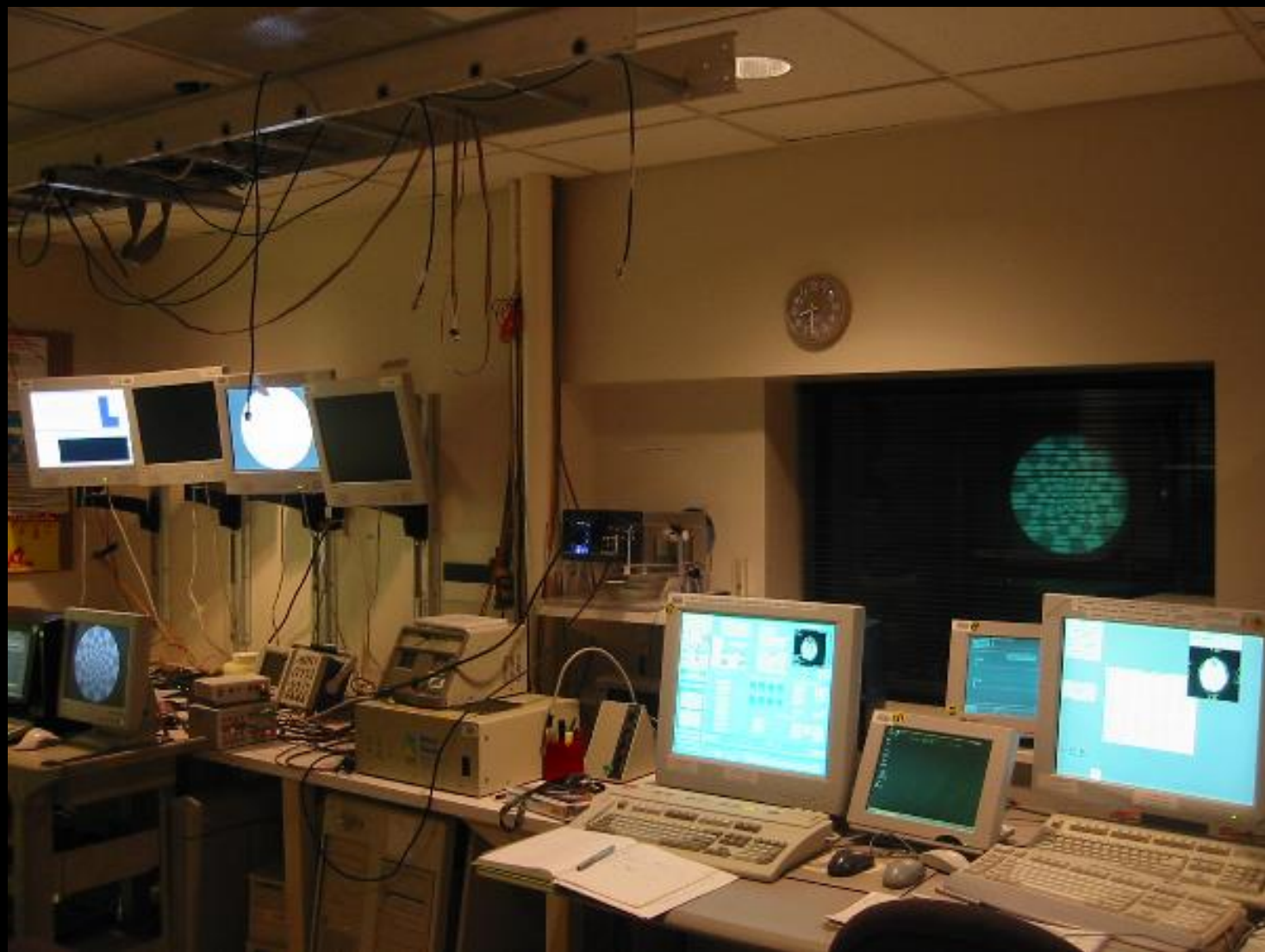

MRI vs. fMRI

MRI

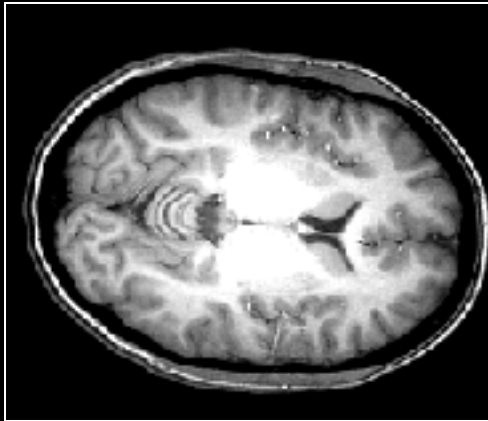

one image

high resolution
(1 mm or less)

fMRI

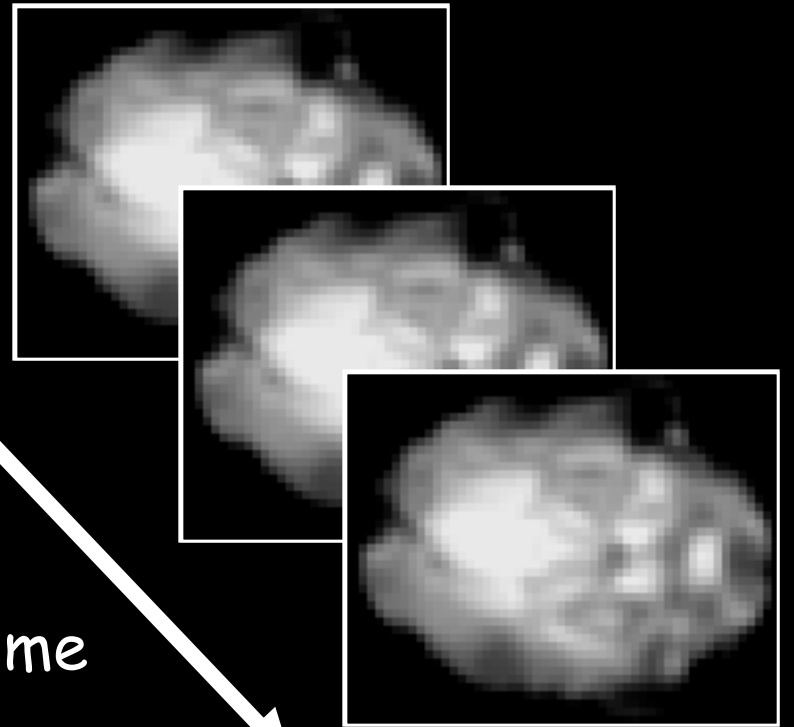

many images
(e.g., every 2 sec for 5 mins)

low resolution
(1.5 to 4 mm)



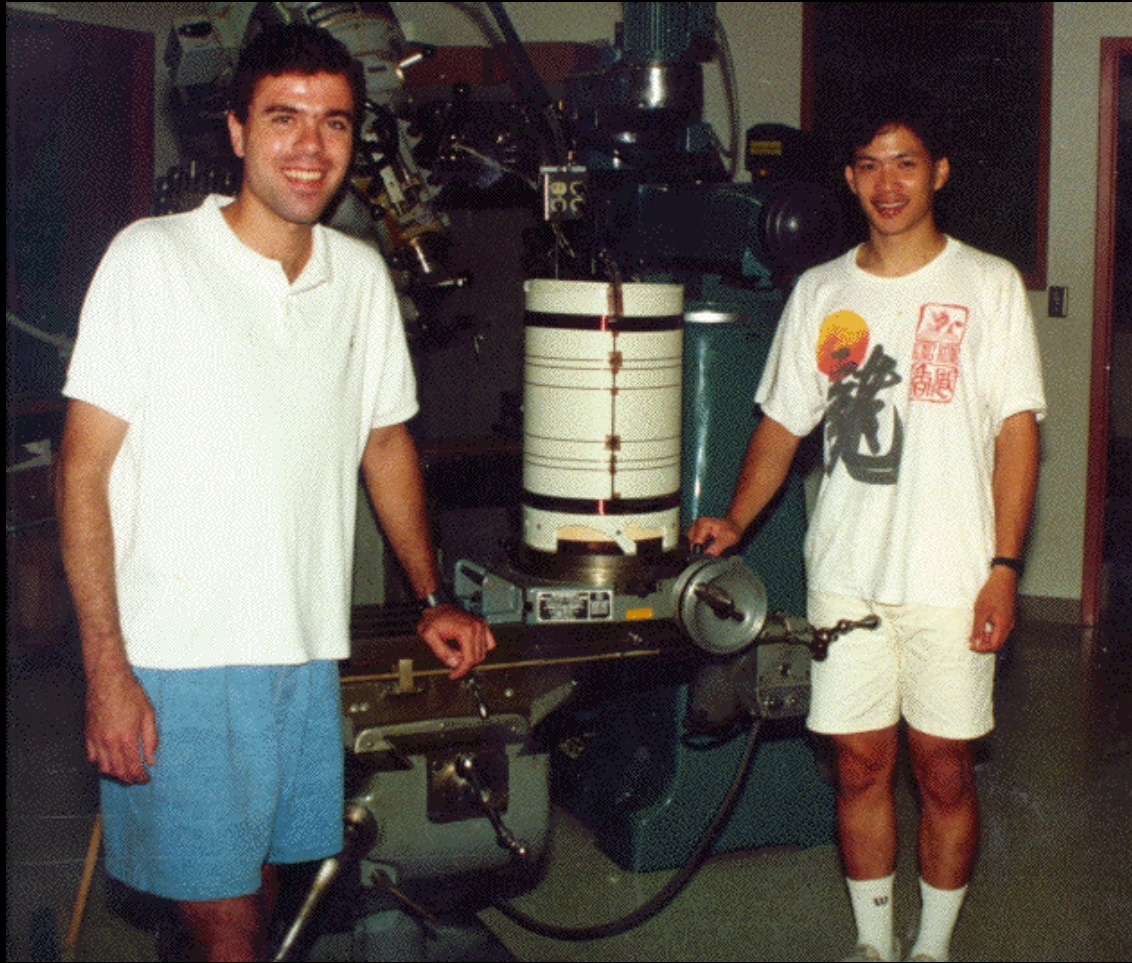

August, 1991

1991-1992



1992-1999



Contrast in Functional MRI

- Blood Volume
- Blood Oxygenation Changes
 - Blood Oxygenation Level Dependent Contrast (BOLD)
- Blood Perfusion



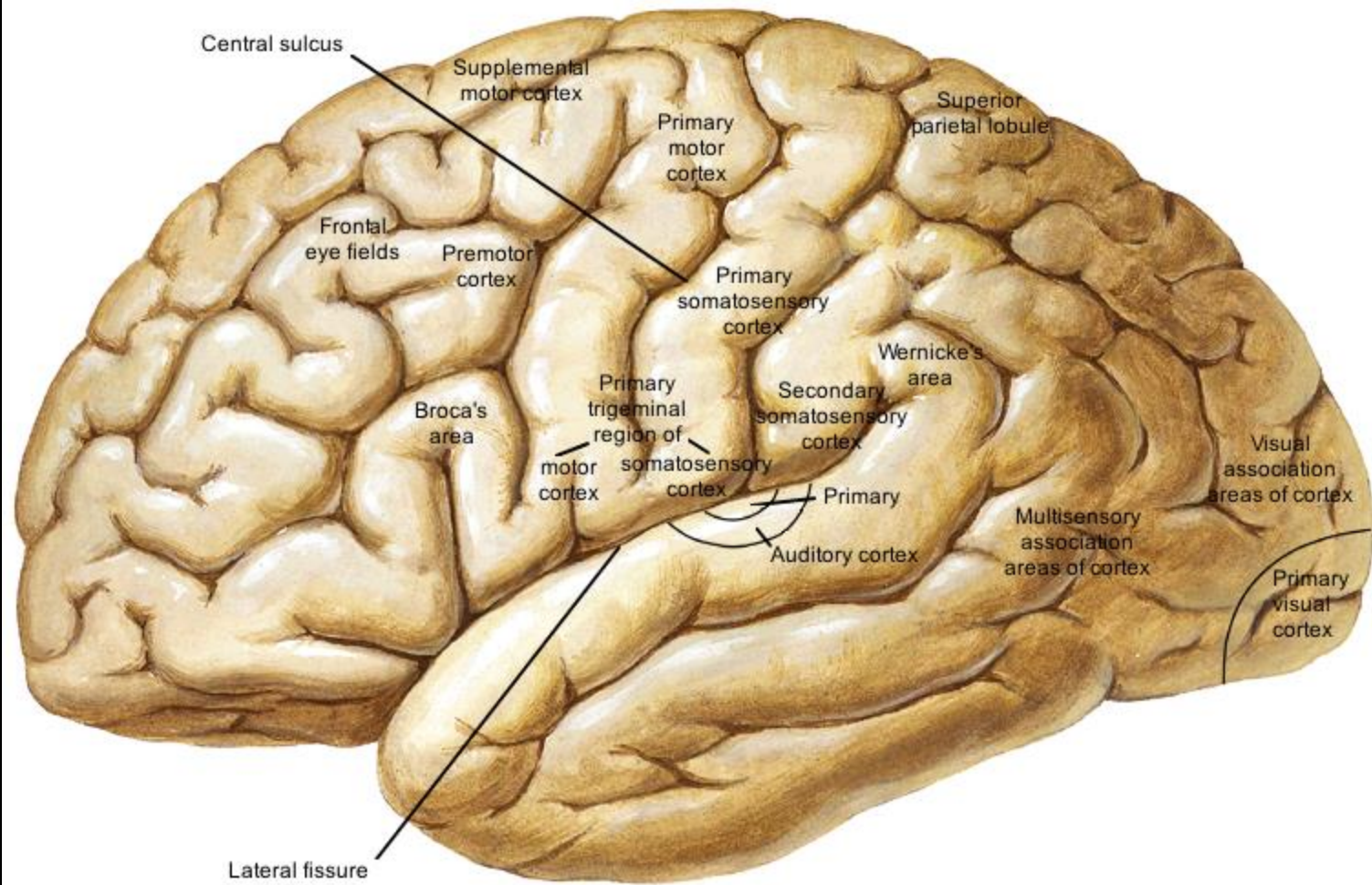

Photic Stimulation

MRI Image showing
activation of the
Visual Cortex

From Belliveau, et al.
Science Nov 1991

MSC - perfusion



Oxygenated and deoxygenated red blood cells have different magnetic properties



red blood cells

oxygenated

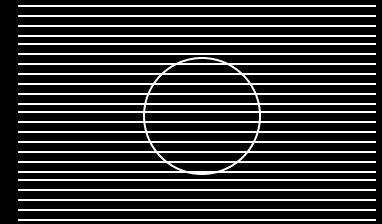

deoxygenated

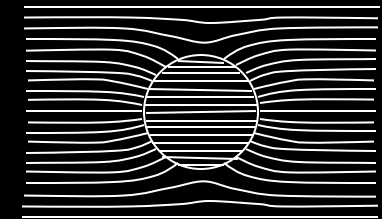

L. Pauling, C. D. Coryell, *Proc. Natl. Acad. Sci. USA* 22, 210-216, **1936**.

K.R. Thulborn, J. C. Waterton, et al., *Biochim. Biophys. Acta.* 714: 265-270, **1982**.

S. Ogawa, T. M. Lee, A. R. Kay, D. W. Tank, *Proc. Natl. Acad. Sci. USA* 87, 9868-9872, **1990**.

BOLD

(blood oxygenation level dependence)

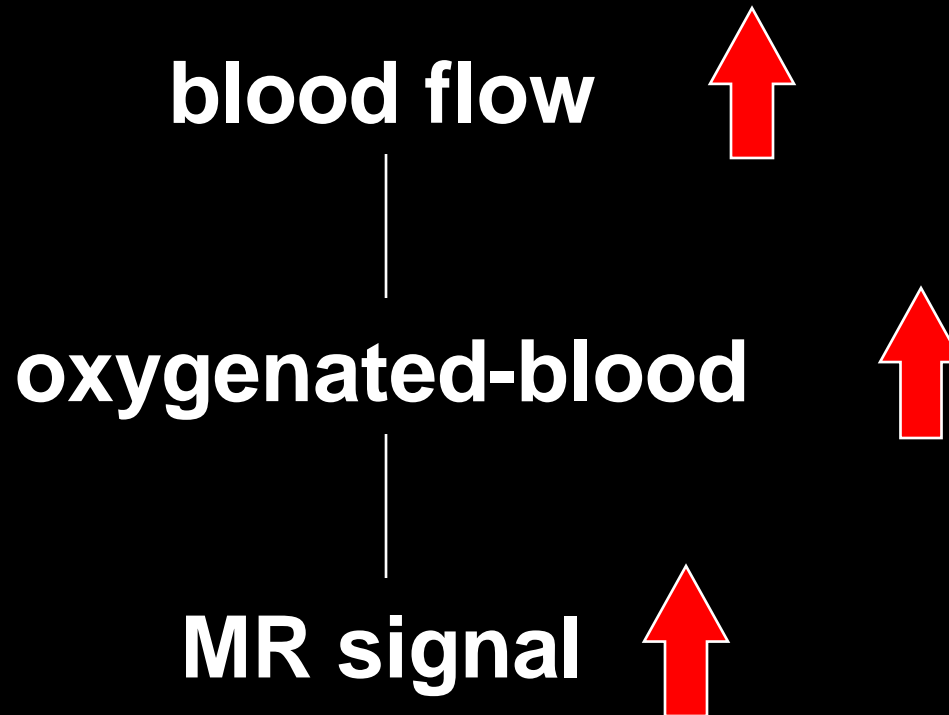

Alternating Left and Right Finger Tapping



Real Time Brain Activation Imaging



•K. K. Kwong, et al, (1992) “Dynamic magnetic resonance imaging of human brain activity during primary sensory stimulation.” Proc. Natl. Acad. Sci. USA. 89, 5675-5679.

•S. Ogawa, et al., (1992) “Intrinsic signal changes accompanying sensory stimulation: functional brain mapping with magnetic resonance imaging. Proc. Natl. Acad. Sci. USA.” 89, 5951-5955.

•P. A. Bandettini, et al., (1992) “Time course EPI of human brain function during task activation.” Magn. Reson. Med 25, 390-397.

•Blamire, A. M., et al. (1992). “Dynamic mapping of the human visual cortex by high-speed magnetic resonance imaging.” Proc. Natl. Acad. Sci. USA 89: 11069-11073.

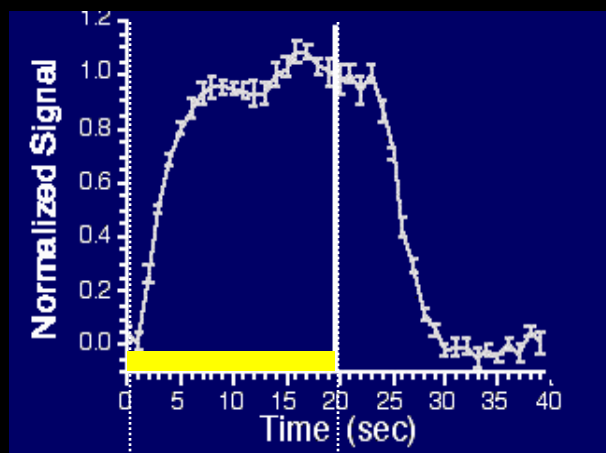

task

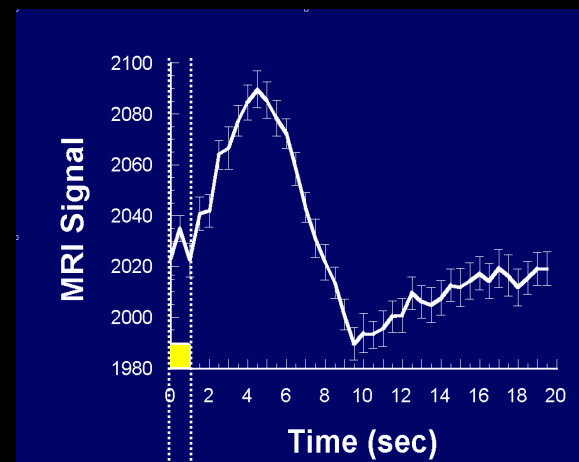

task



Cross Correlation Image

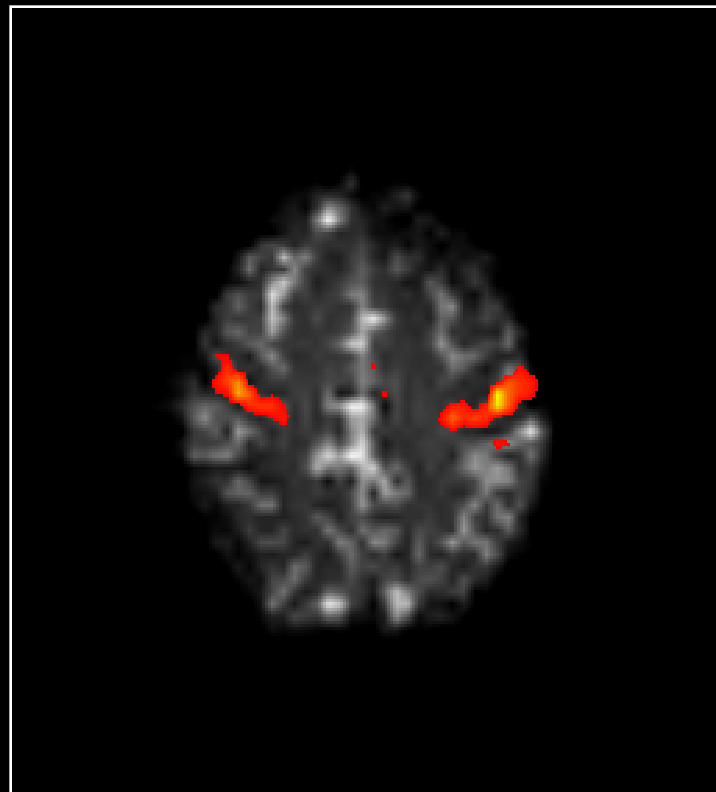

Cross Correlation Image
Anatomical Image



Technology

Methodology

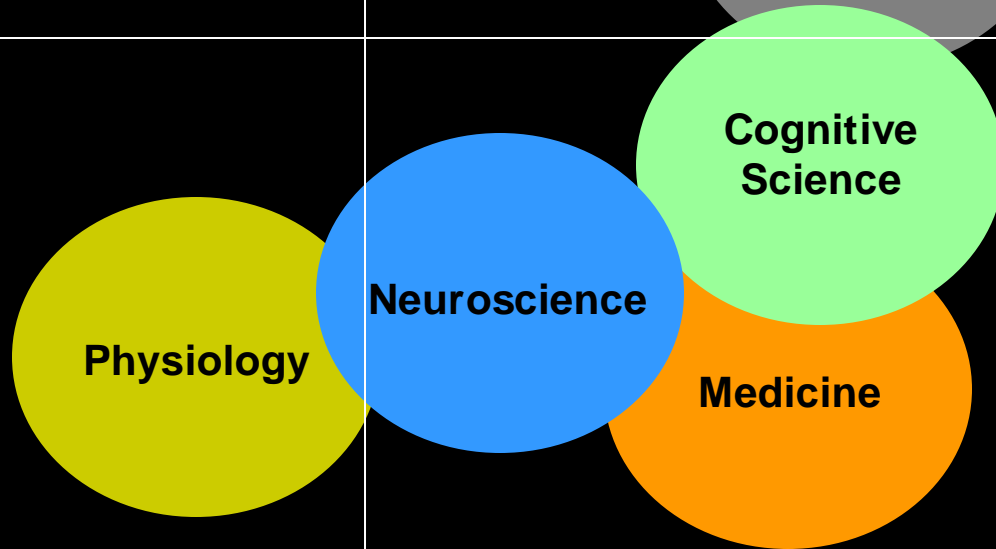
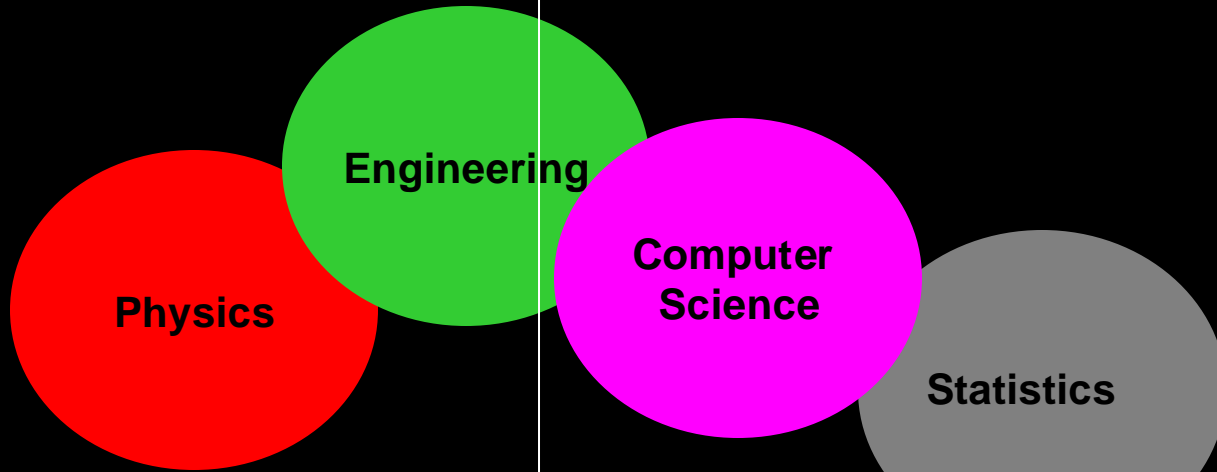

Interpretation

Applications

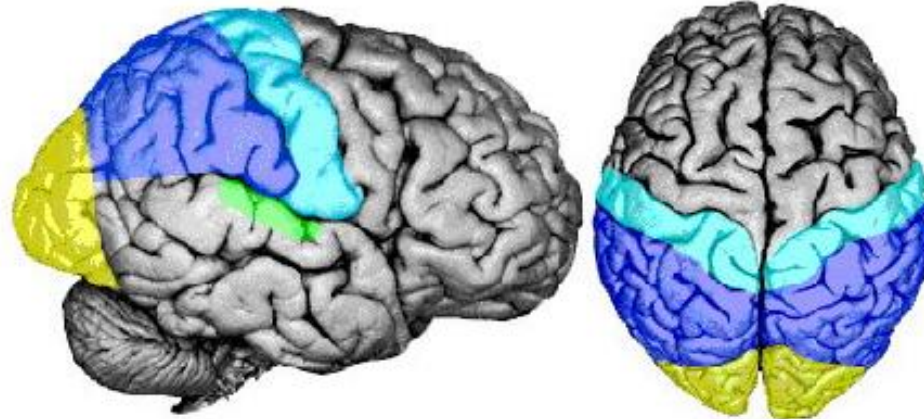

■ Parietal/
Somatosensory
■ Parietal/
Association Area

■ Occipital/Vision
■ Auditory

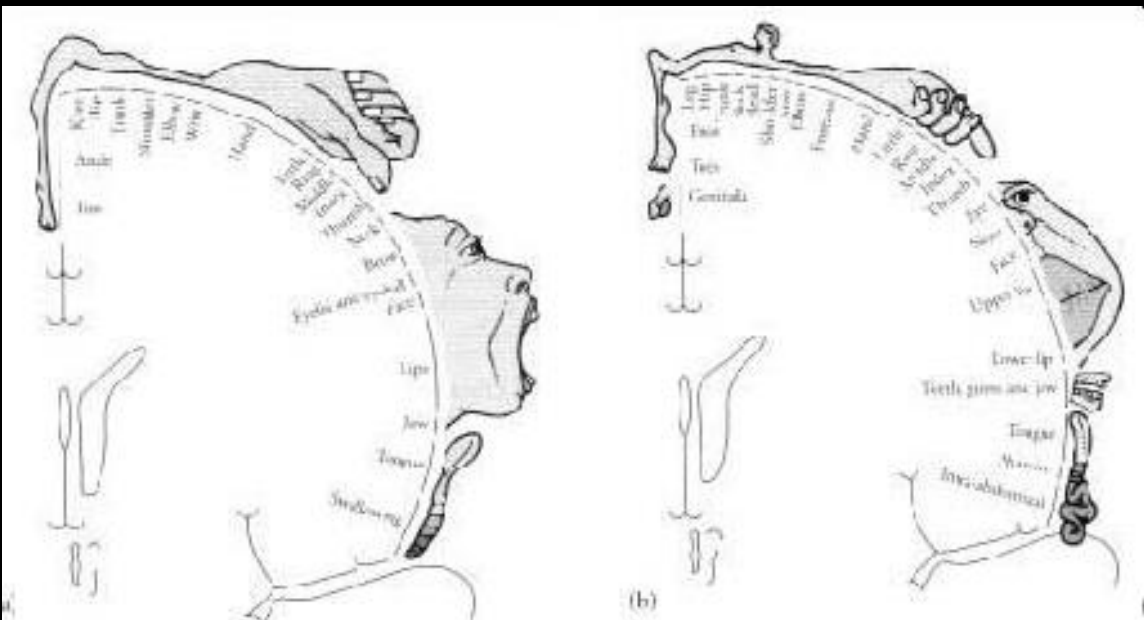

Left

Right

Toe movement

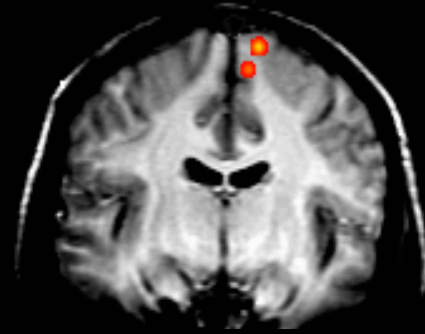
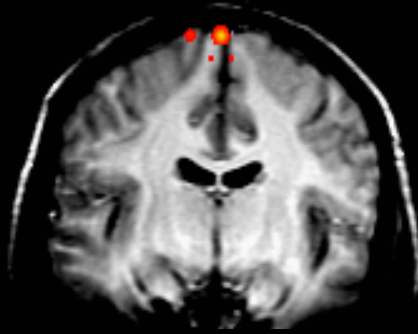

Finger movement

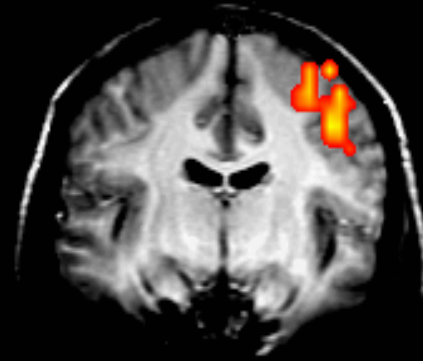
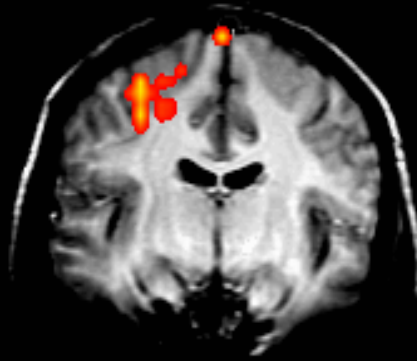

Finger Movement

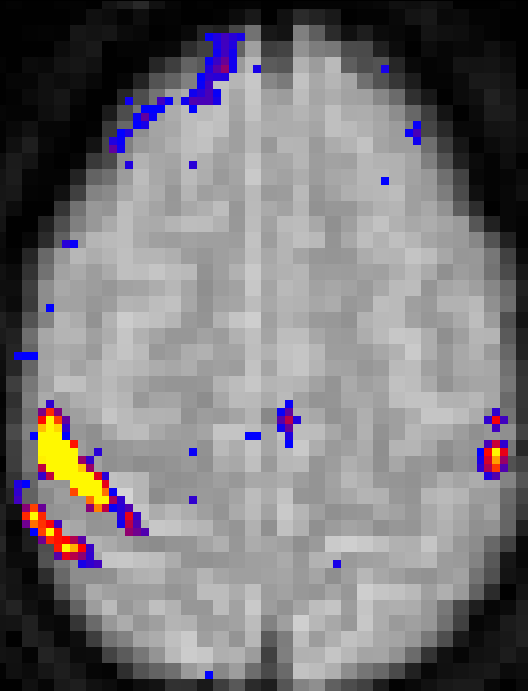

Tactile Stimulation

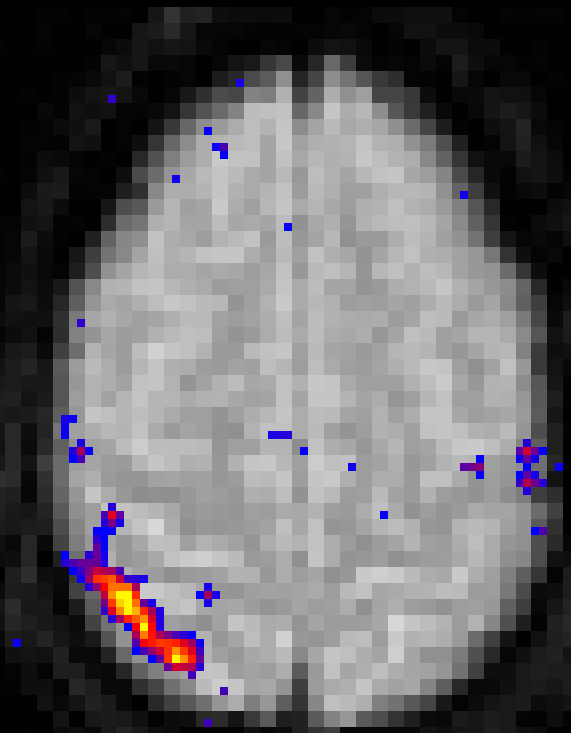

Simple Right

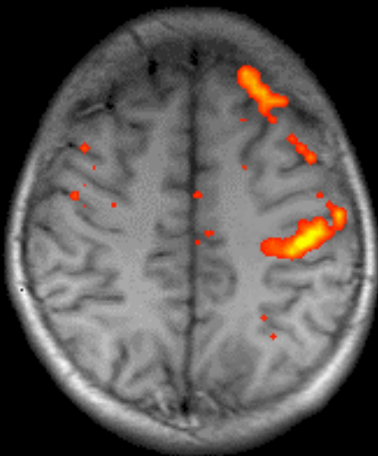

Complex Right

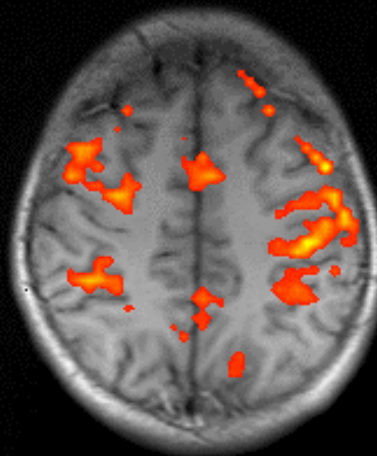

Imagined Complex Right

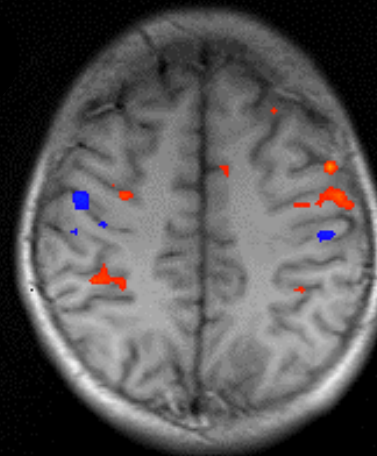

Simple Left

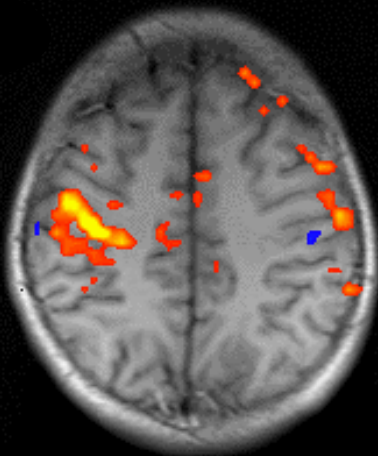

Complex Left

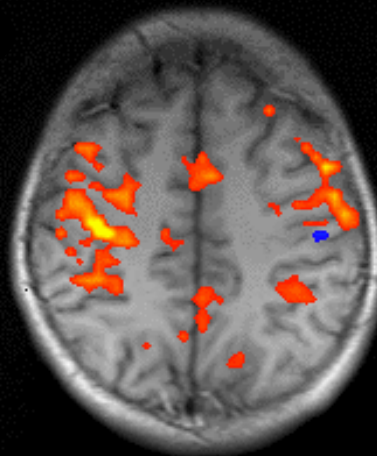

Imagined Complex Left

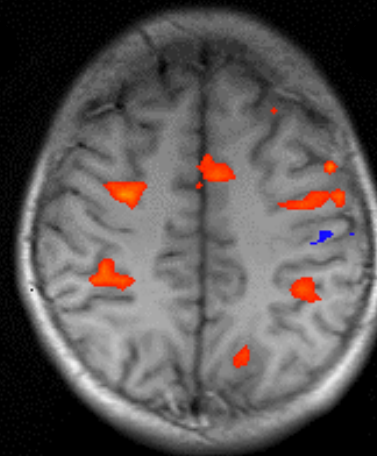

Left

Simple Finger Movement on the Right Hand

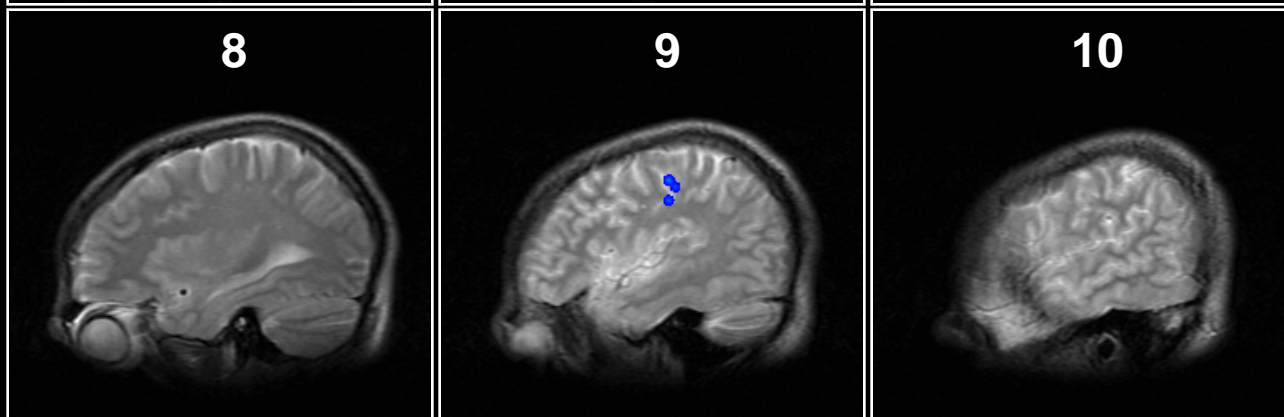
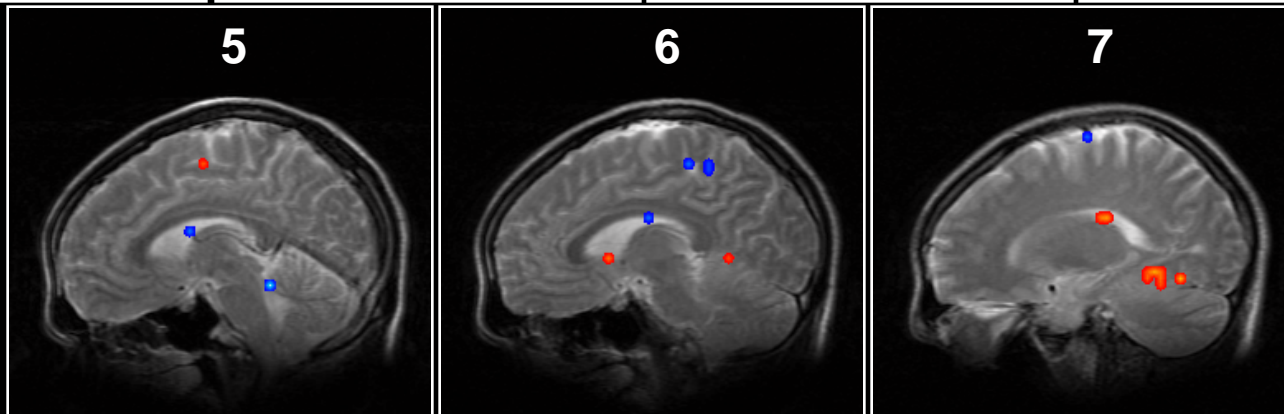
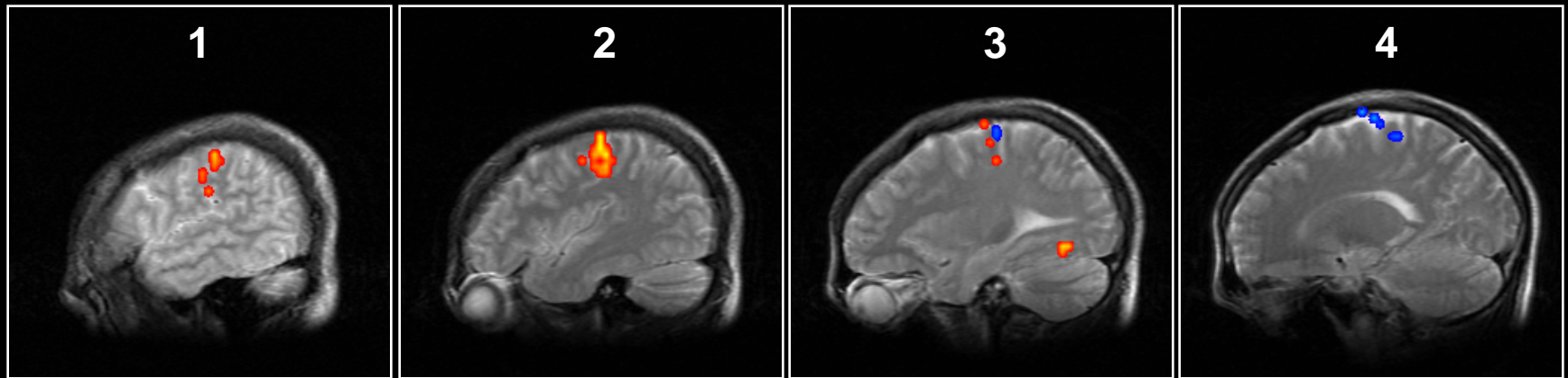

Right

Left

Complex Finger Movement on the Right Hand

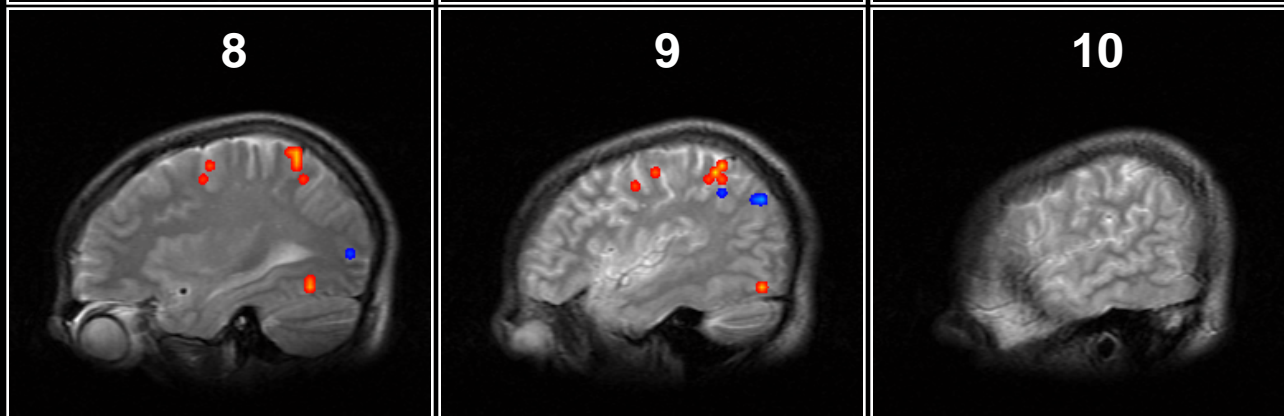
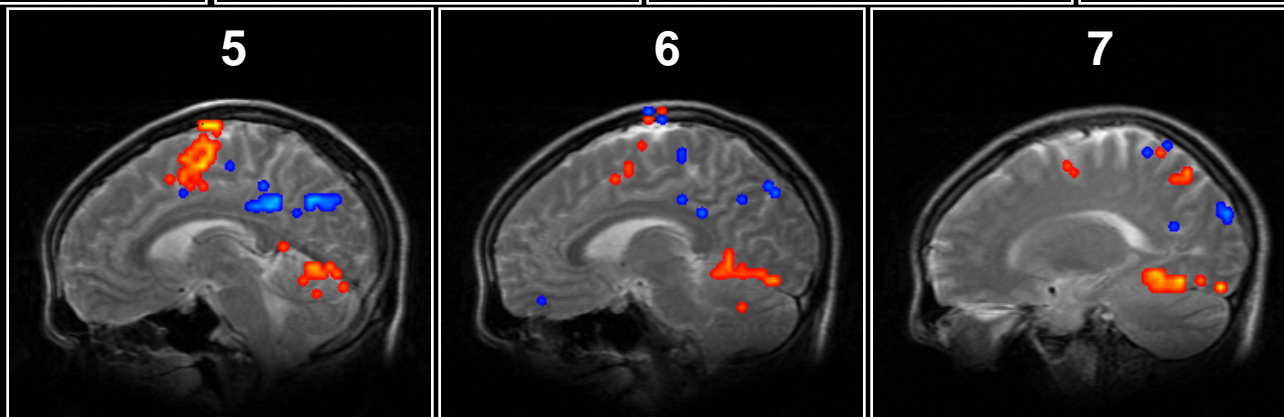
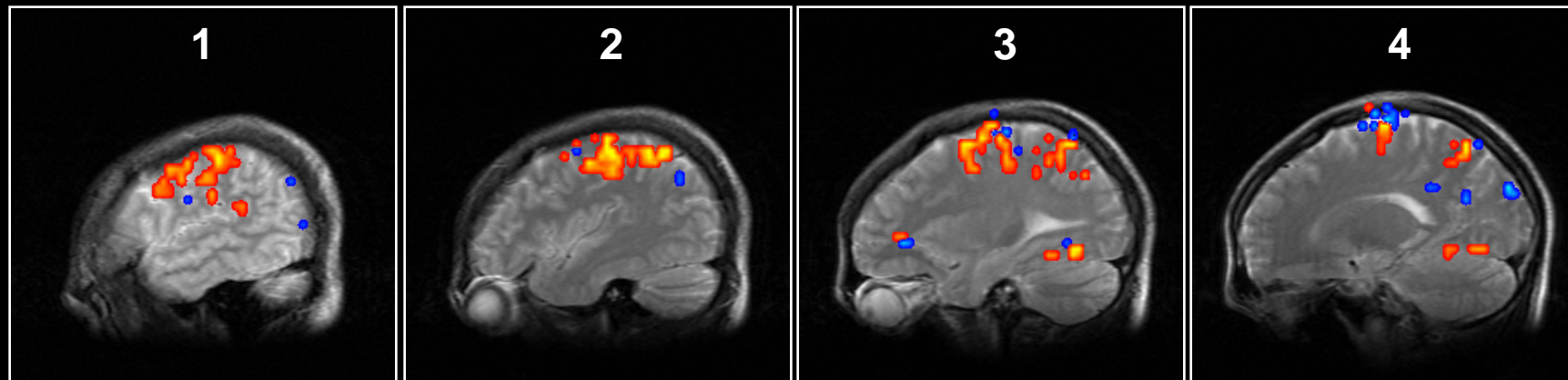

Right

Left

Imagined Complex Finger Movement on the Right Hand

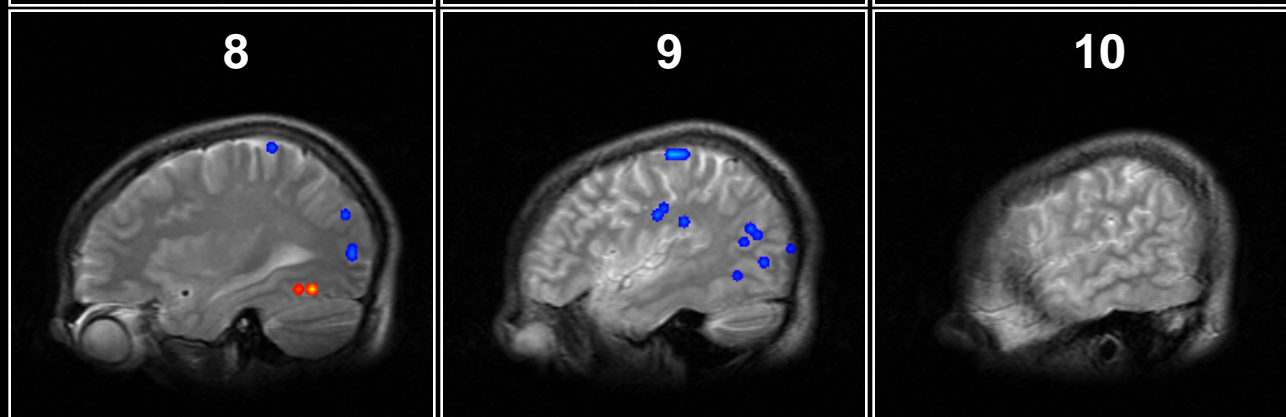
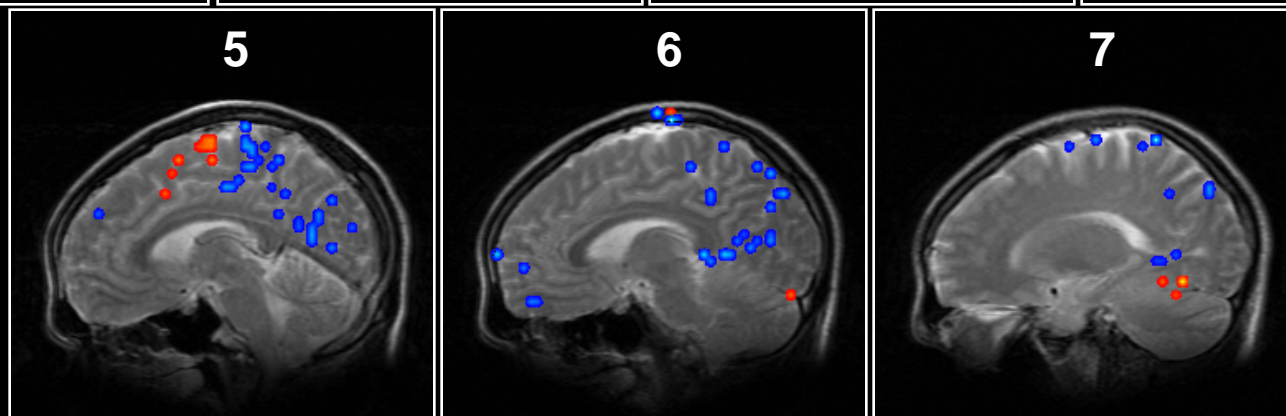
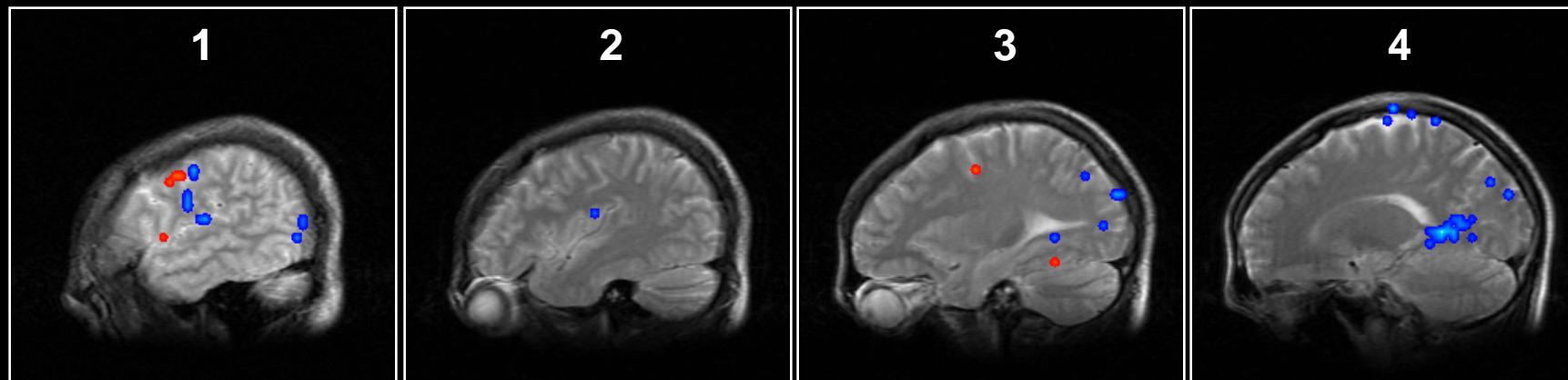

Right

Presurgical Mapping

Left Foot

Tumor

Right Foot

Right Hand

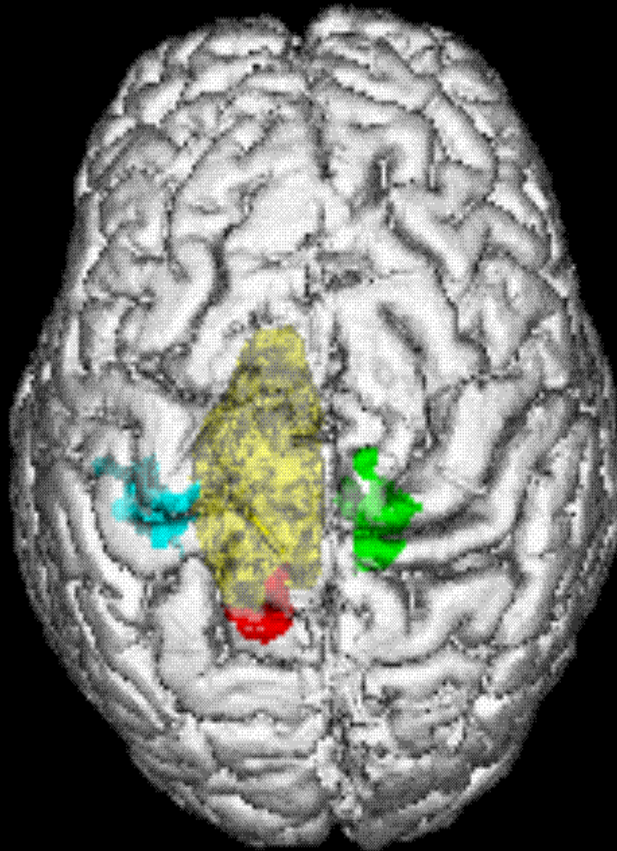

fMRI

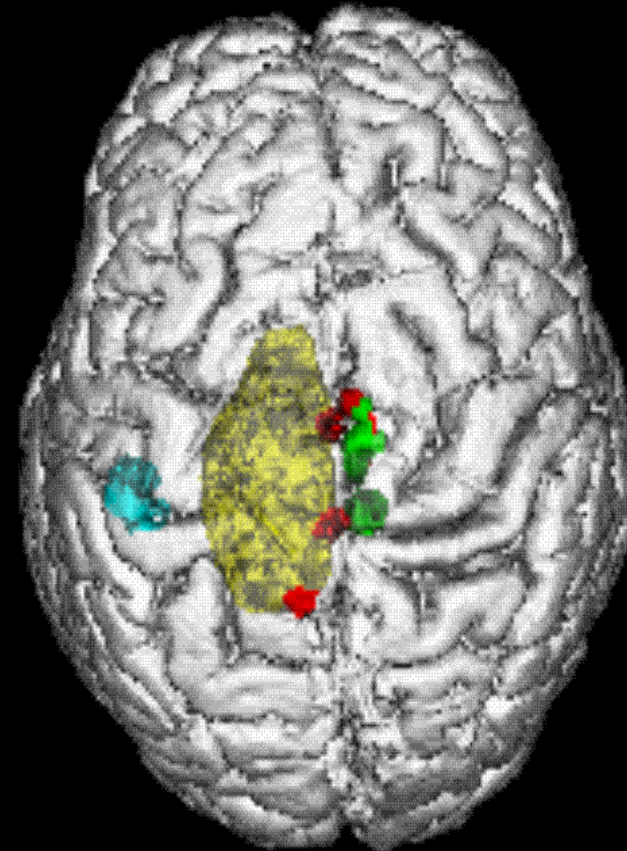

O-15 PET

Reading

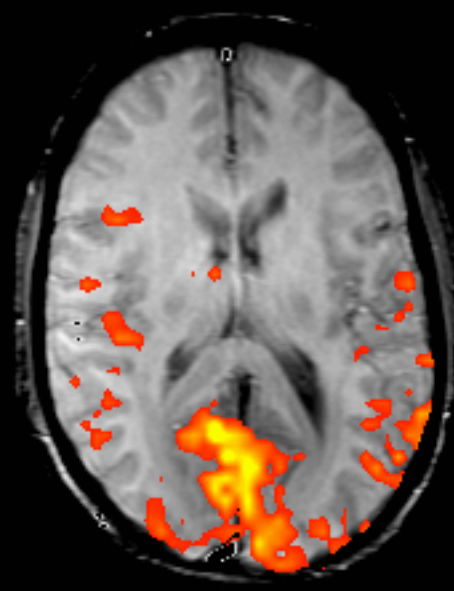
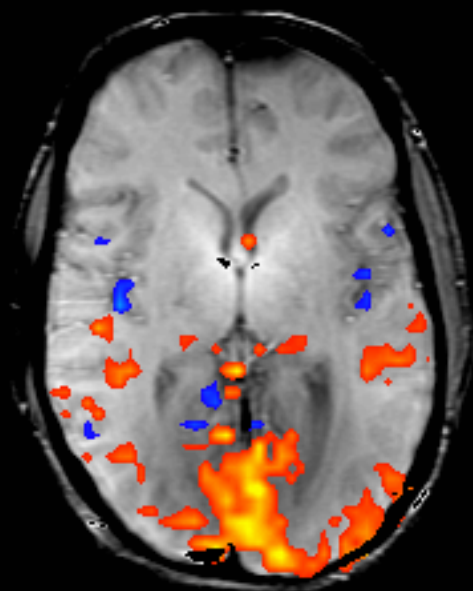

Listening

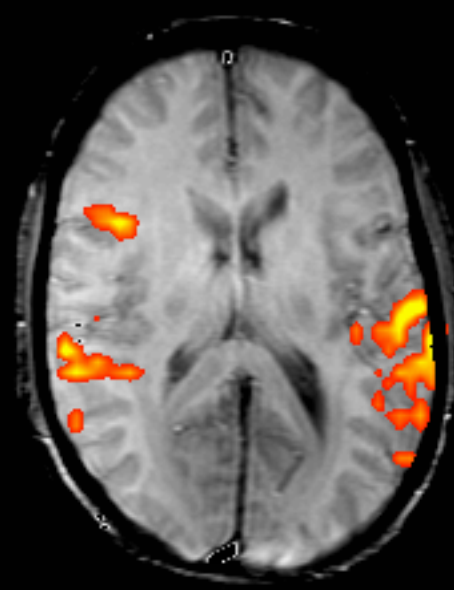
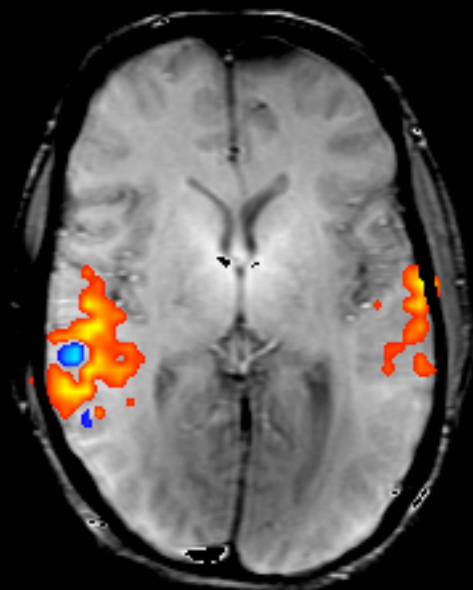

Visual Pathways: The Retino-Geniculo-Calcarine Pathway

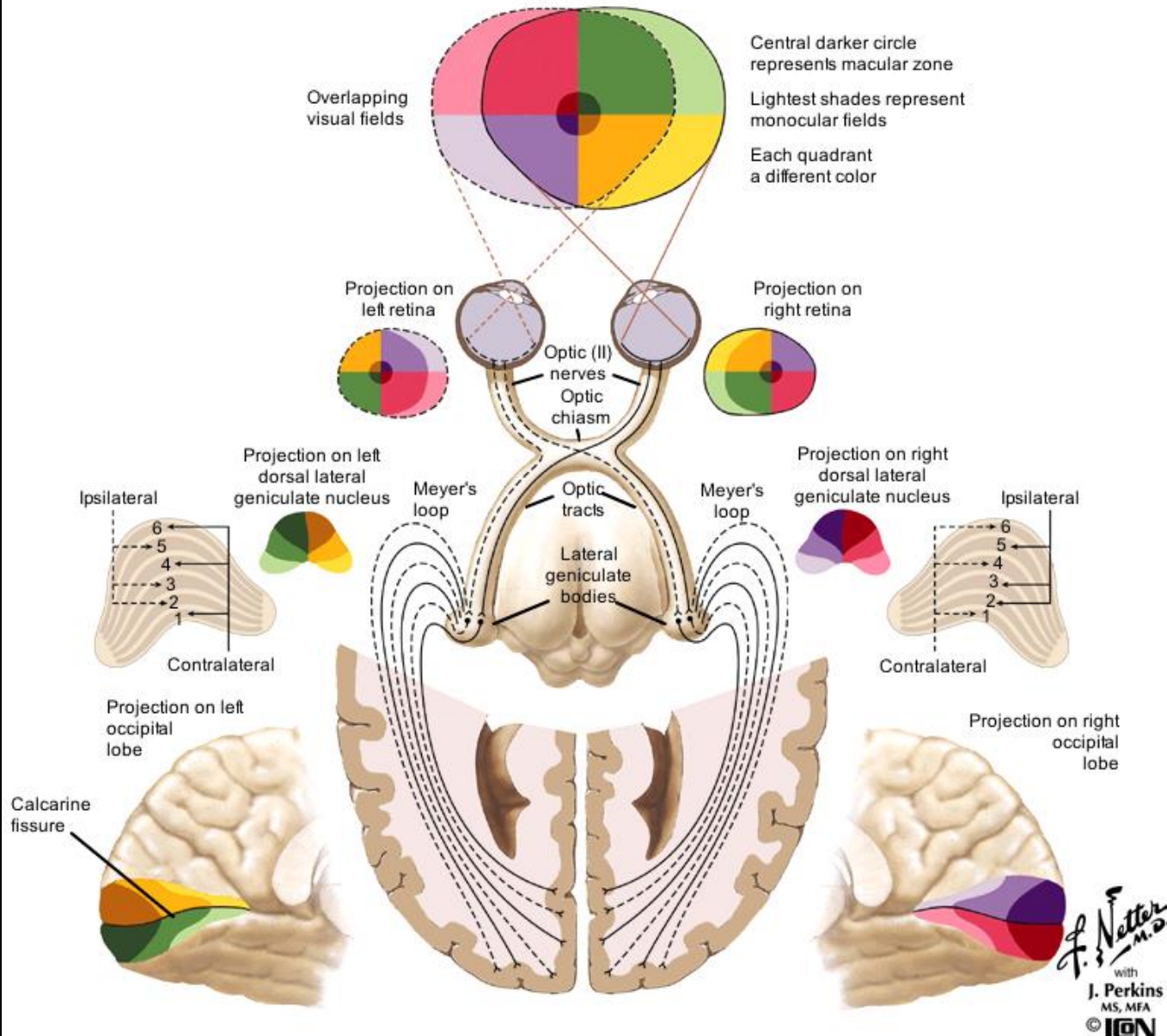

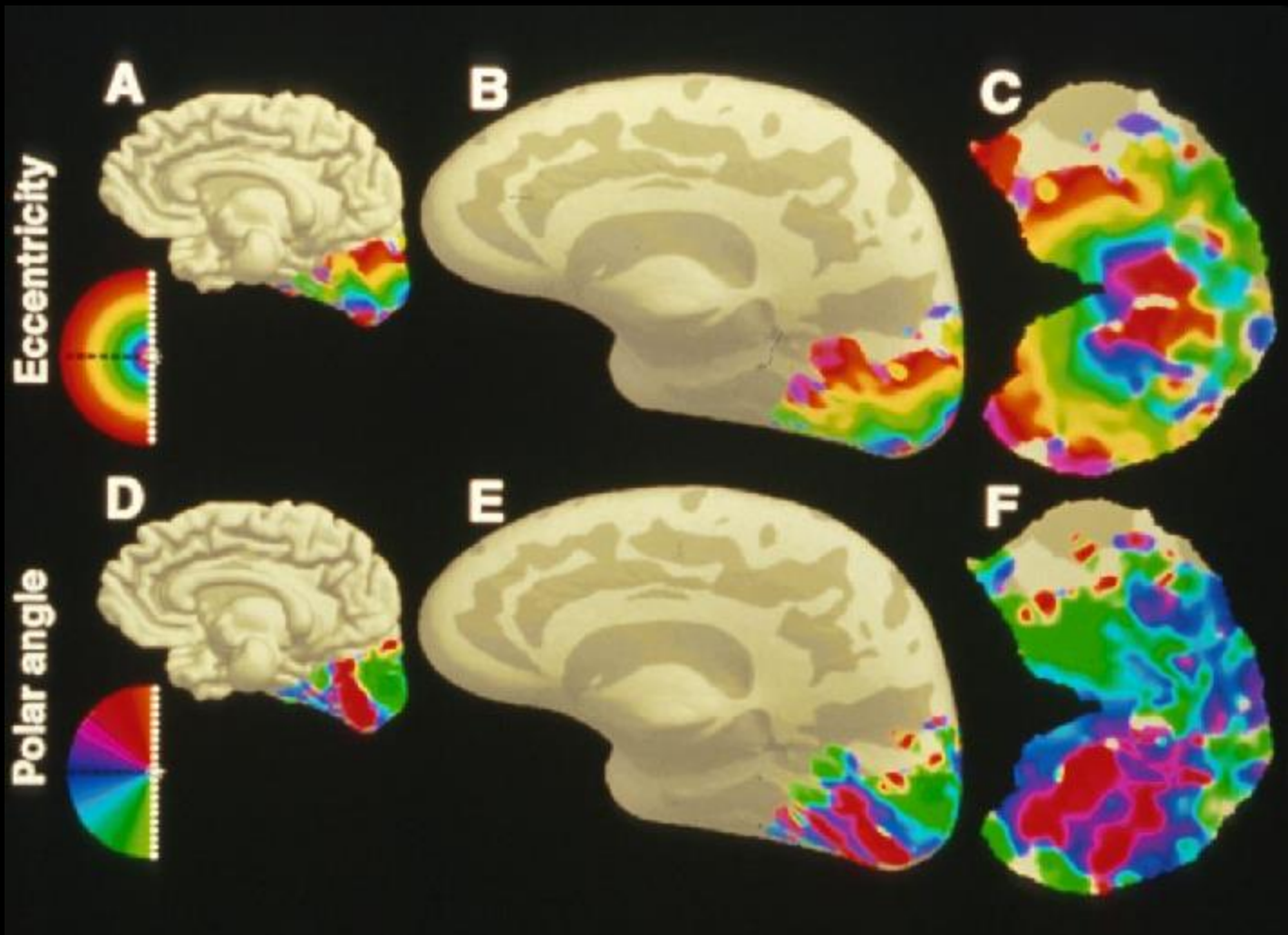

ODC Maps using fMRI

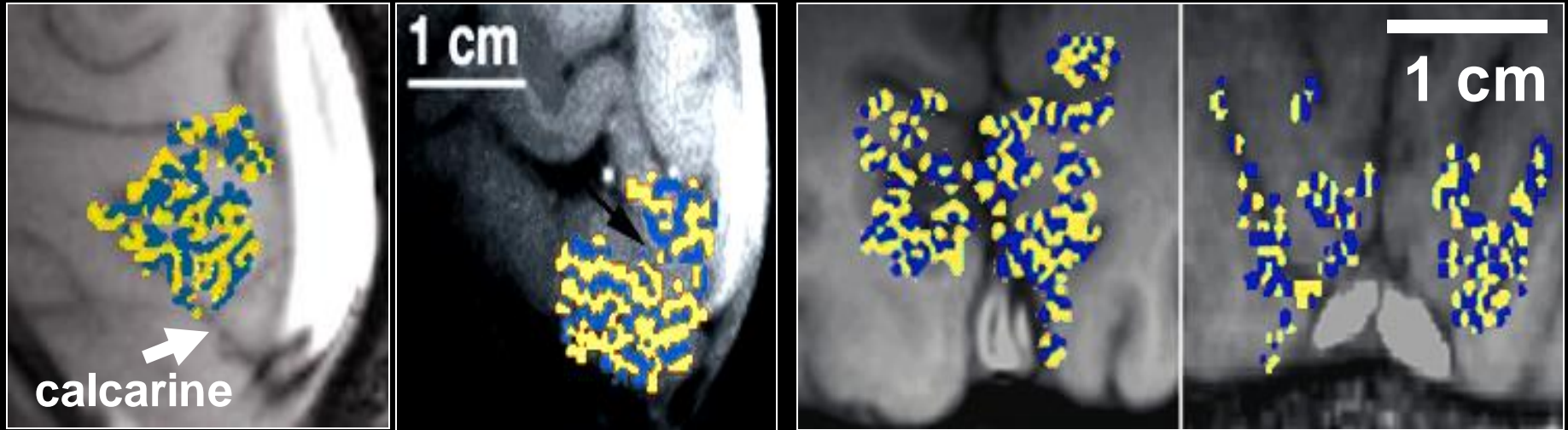

- Identical in size, orientation, and appearance to those obtained by optical imaging¹ and histology^{3,4}.

Menon et al.

¹Malonek D, Grinvald A. *Science* 272, 551-4 (1996).

³Horton JC, Hocking DR. *J Neurosci* 16, 7228-39 (1996).

⁴Horton JC, et al. *Arch Ophthalmol* 108, 1025-31 (1990).

Word stem completion

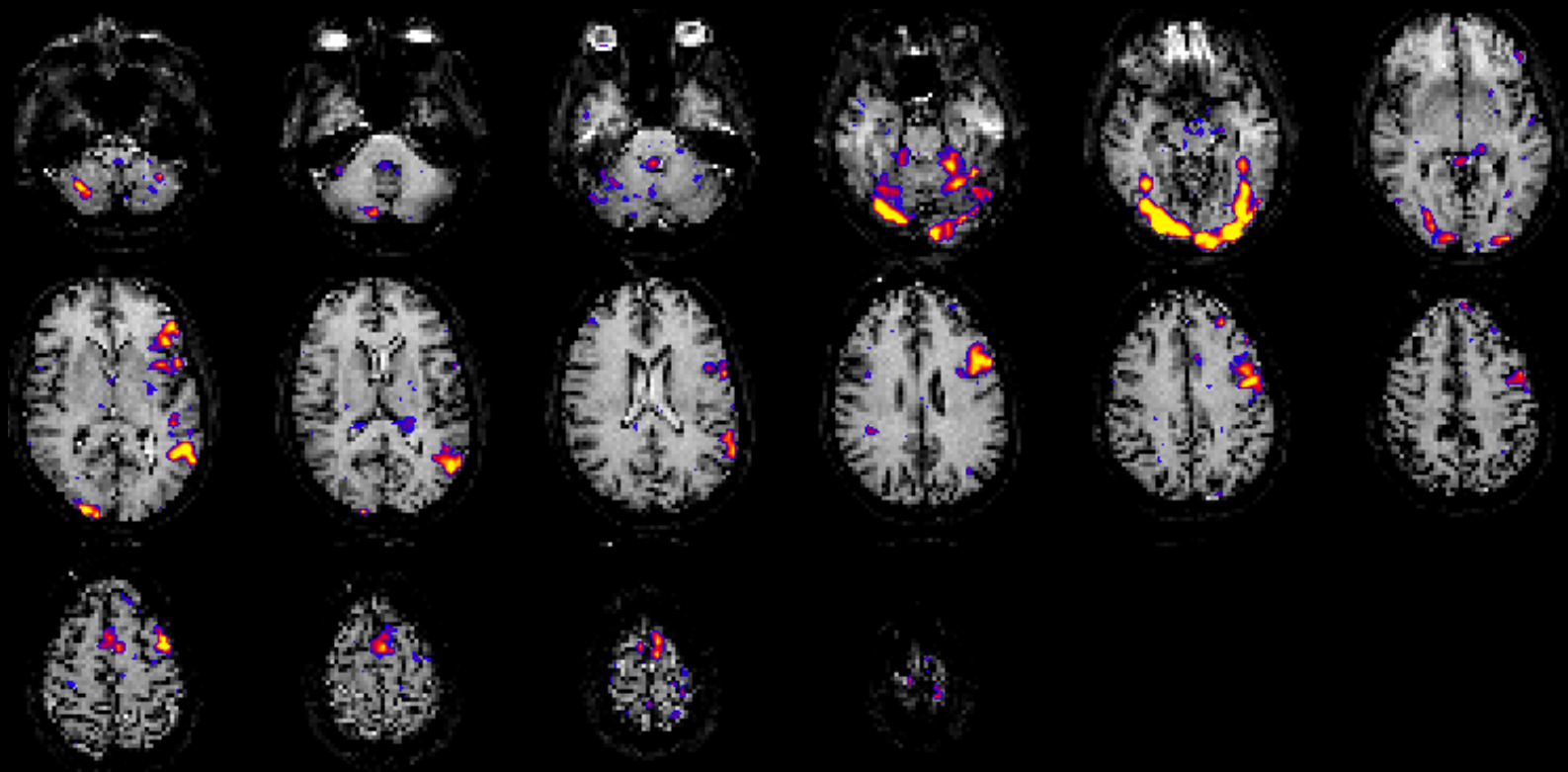

Applications

Real time fMRI feedback to reduce chronic pain

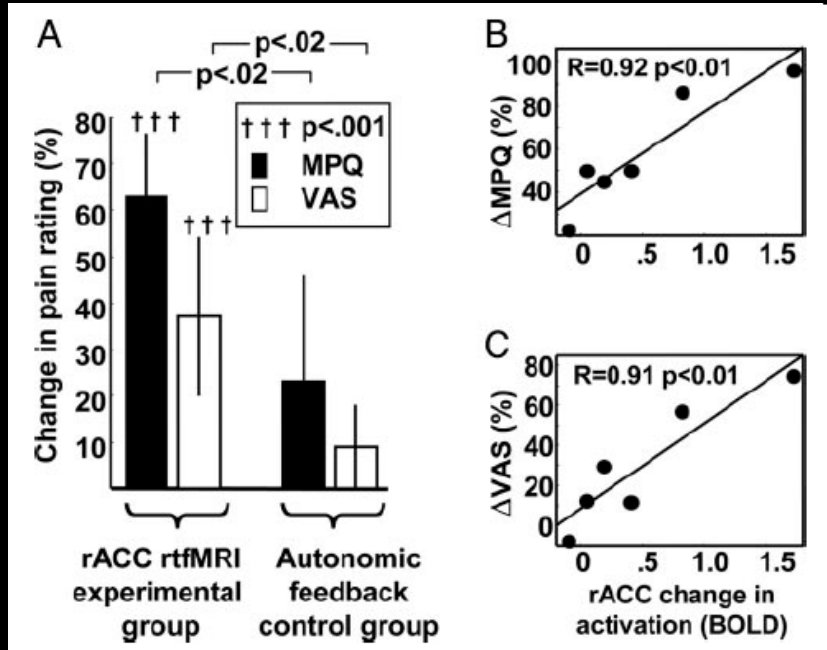
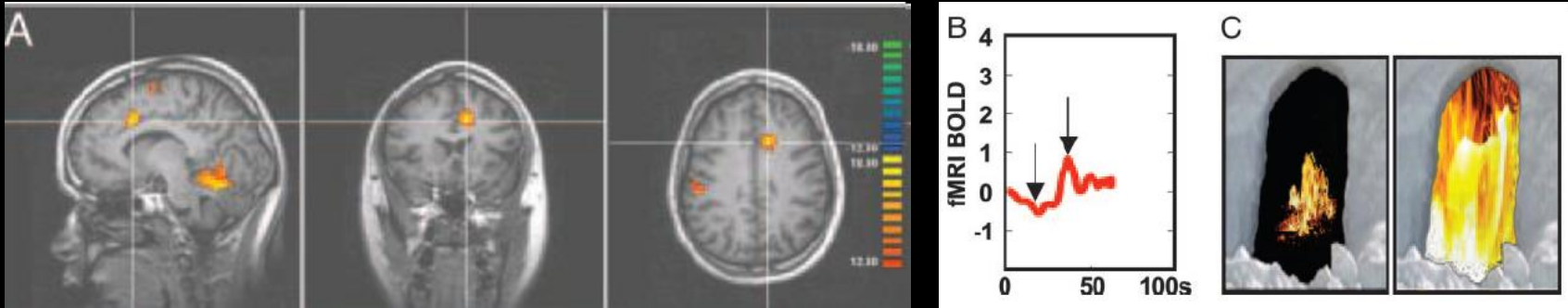

Control over brain activation and pain learned by using real-time functional MRI, R. C. deCharms, et al. PNAS, 102; 18626-18631 (2005)

Neural Correlates of Visual Working Memory: fMRI Amplitude Predicts Task Performance

Luiz Pessoa,¹ Eva Gutierrez, Peter A. Bandettini,
and Leslie G. Ungerleider
Laboratory of Brain and Cognition
National Institute of Mental Health
National Institutes of Health
Bethesda, Maryland 20892

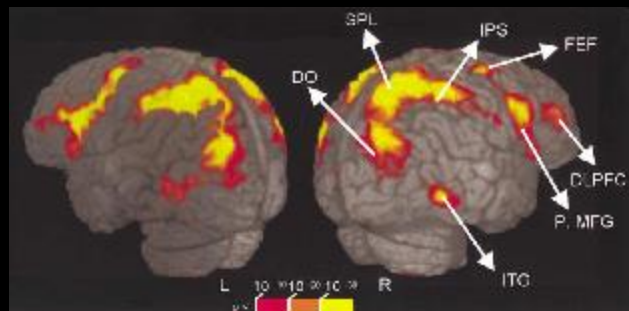

A. Encoding

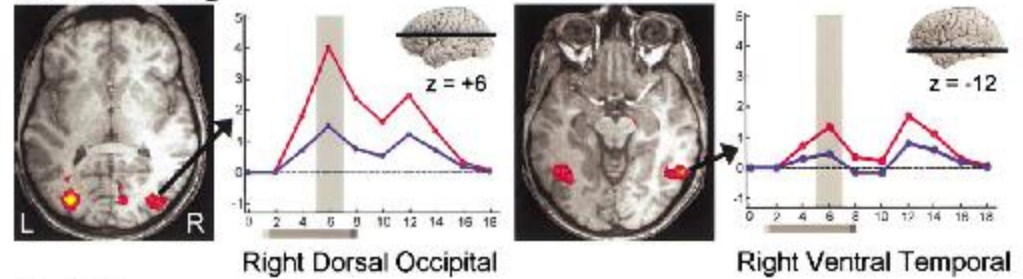

B. Delay

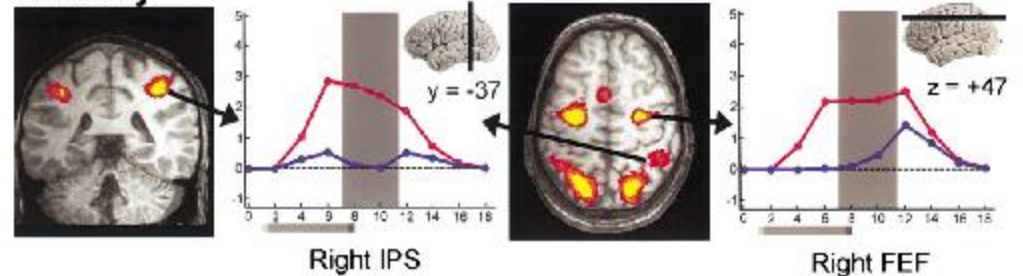

C. Test

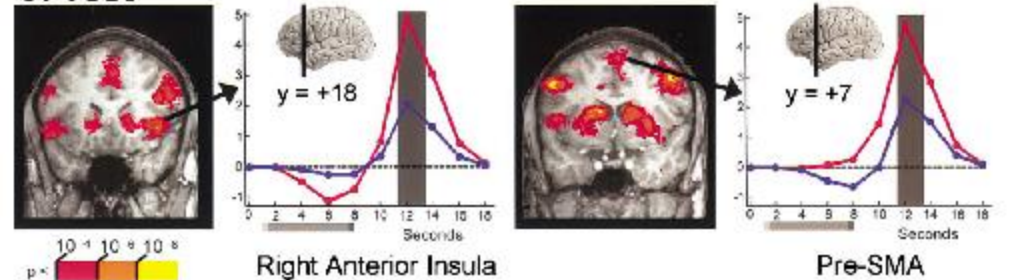

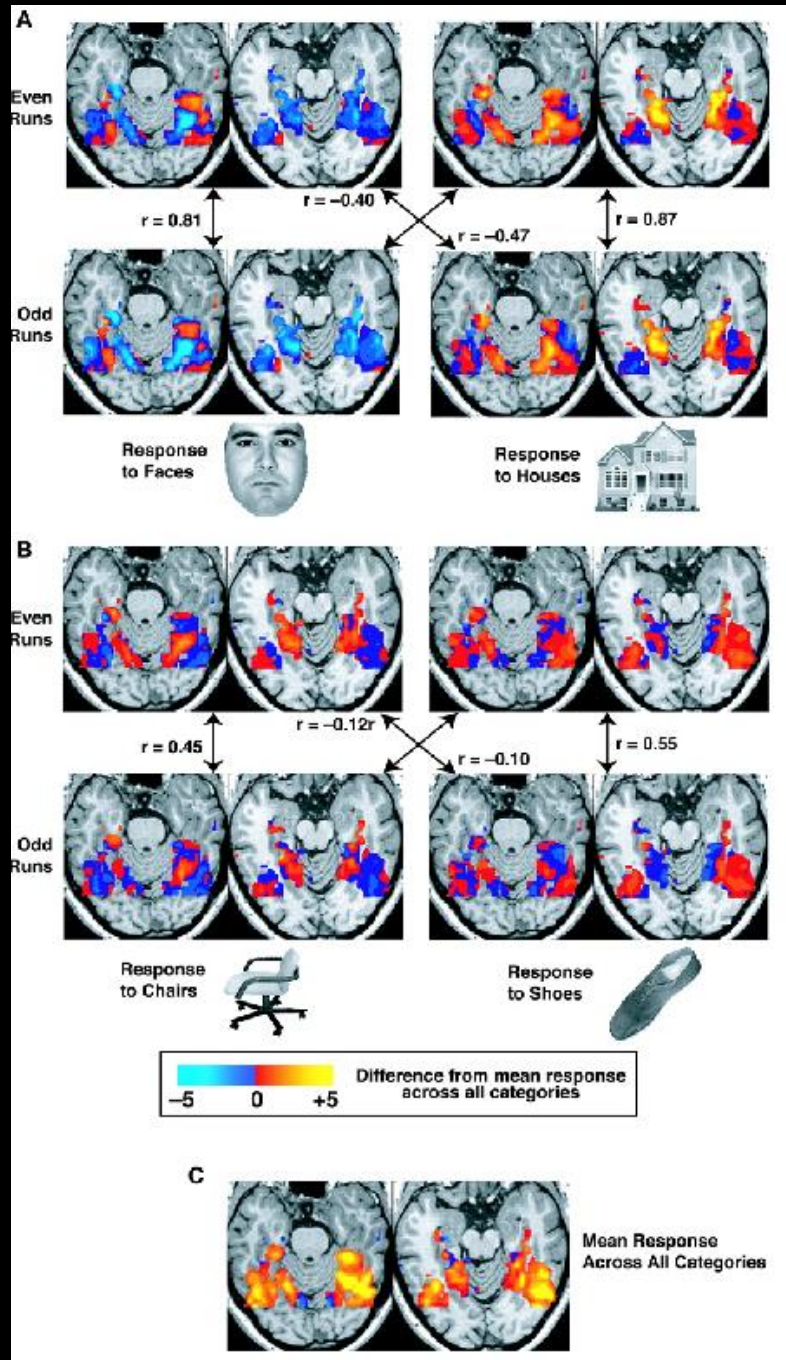

Haxby et al (2001)

Lie Detection by Functional Magnetic Resonance Imaging

Tatia M.C. Lee,^{1*} Ho-Ling Liu,² Li-Hai Tan,³ Chetwyn C.H. Chan,⁴
Srikanth Mahankali,⁵ Ching-Mei Feng,⁵ Jinwen Hou,⁵
Peter T. Fox,⁵ and Jia-Hong Gao⁵

(a) Digit Memory Task

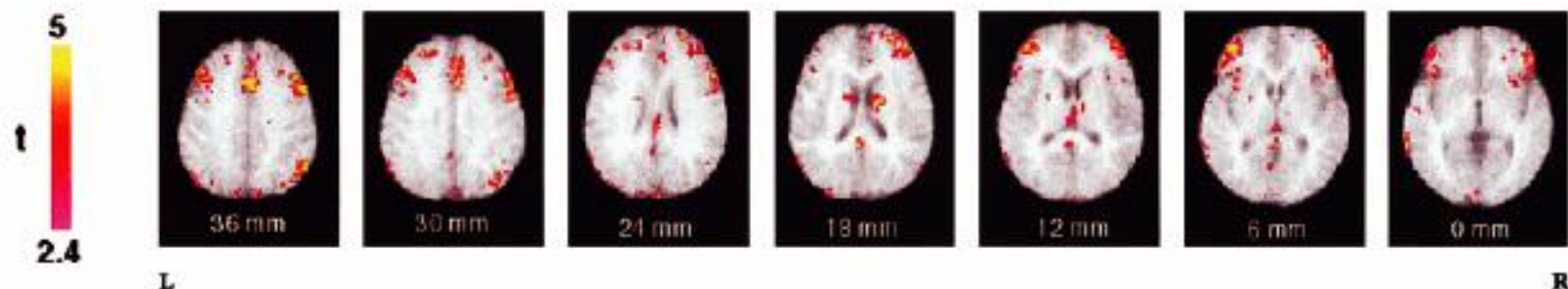

(b) Autobiographic Memory Task

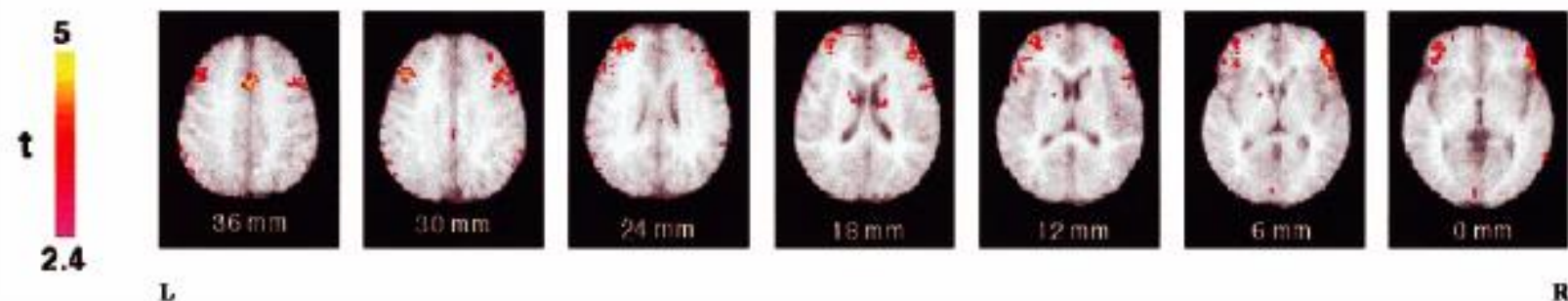

Figure 1.

Functional maps. Normalized activation brain maps averaged across five subjects demonstrating the statistically significant activations ($P < 0.01$) in the faking memory impairment condition with the activation for making accurate recall removed when perform-

ing on forced choice testing using (a) Digit Memory and (b) Autobiographic Memory tasks. Planes are axial sections, labeled with the height (mm) relative to the bicommissural line. L, left hemisphere; R, right hemisphere.

Topics Studied with fMRI at the NIH

- Epilepsy
- Visual processing
- Mood disorders
- Learning
- Habituation
- Plasticity
- Motor Function
- Auditory processing
- Attention
- Language
- Speech
- Stroke
- Social Interaction
- Development
- Aging
- Genetics

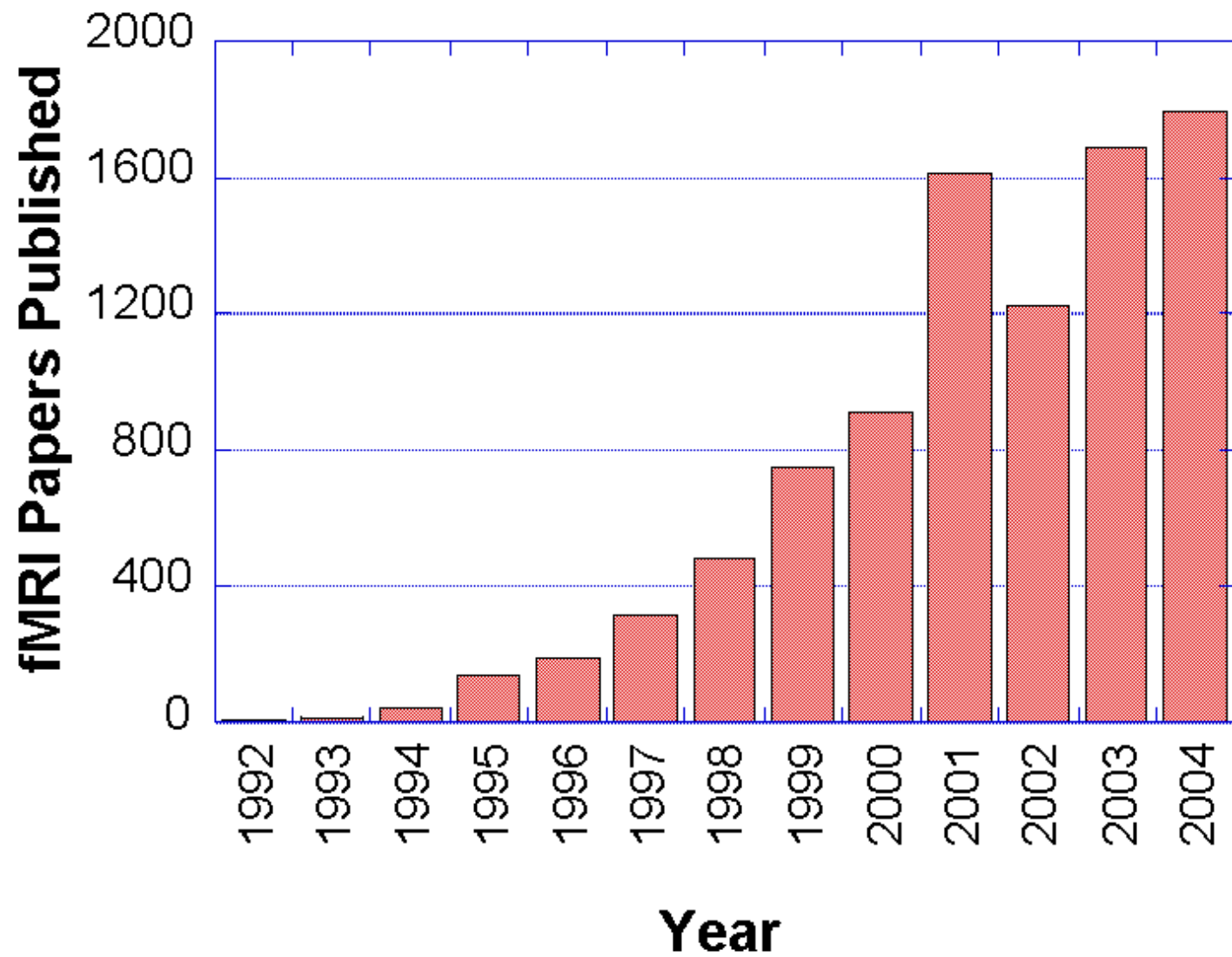

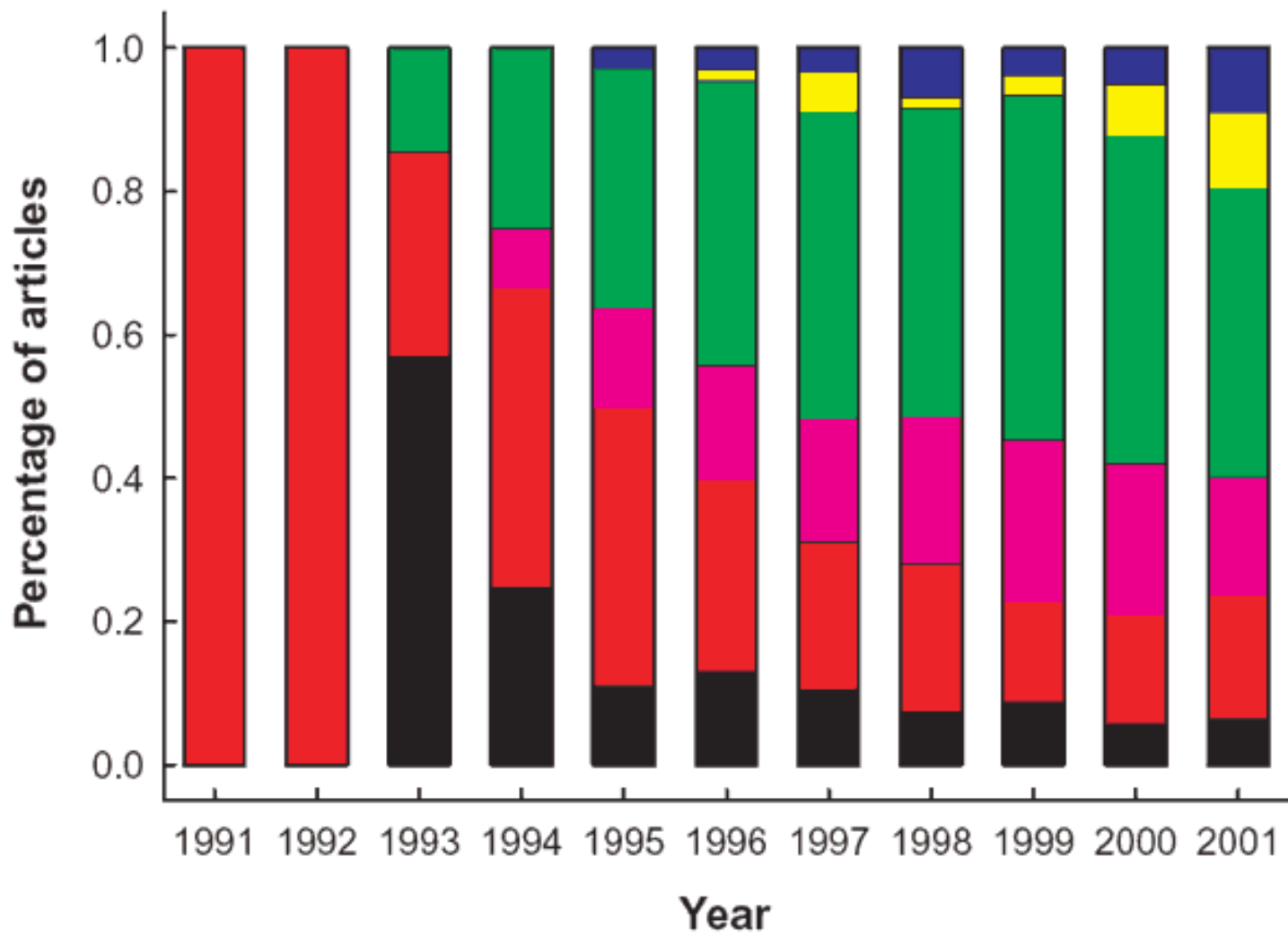

Motor (black)
Primary Sensory (red)
Integrative Sensory (violet)
Basic Cognition (green)
High-Order Cognition (yellow)
Emotion (blue)

J. Illes, M. P. Kirschen, J.
 D. E. Gabrielli, *Nature*
Neuroscience, 6 (3)m p.205

Current Uses of fMRI

Understanding normal brain organization and changes

- networks involved with specific tasks (low to high level processing)
- changes over time (seconds to years)
- correlates of behavior (response accuracy, performance changes...)

Clinical research

- correlates of specifically activated networks to clinical populations
- presurgical mapping
- epileptic foci mapping
- drug effects

Potential uses of fMRI

Complementary use for clinical diagnosis

- utilization of clinical research results

Clinical treatment and assessment

- drug, therapy, rehabilitation, biofeedback

Non clinical uses

- complementary use with behavioral results
- lie detection
- prediction of behavior tendencies (many contexts)
- brain/computer interface

Functional Neuroimaging Techniques

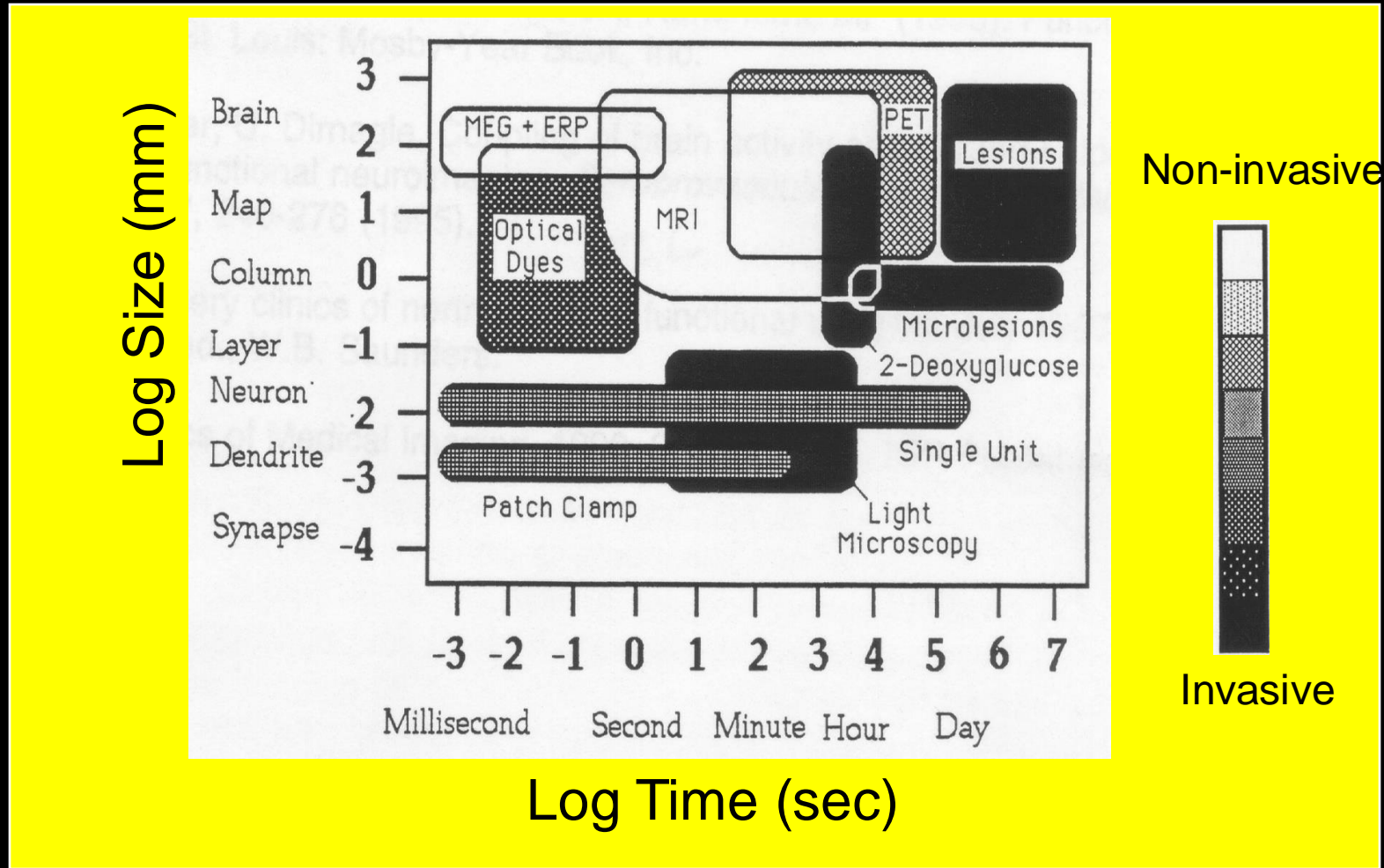

**electric
current**

**magnetic
field**

**intracellular
current
(dendrite)**

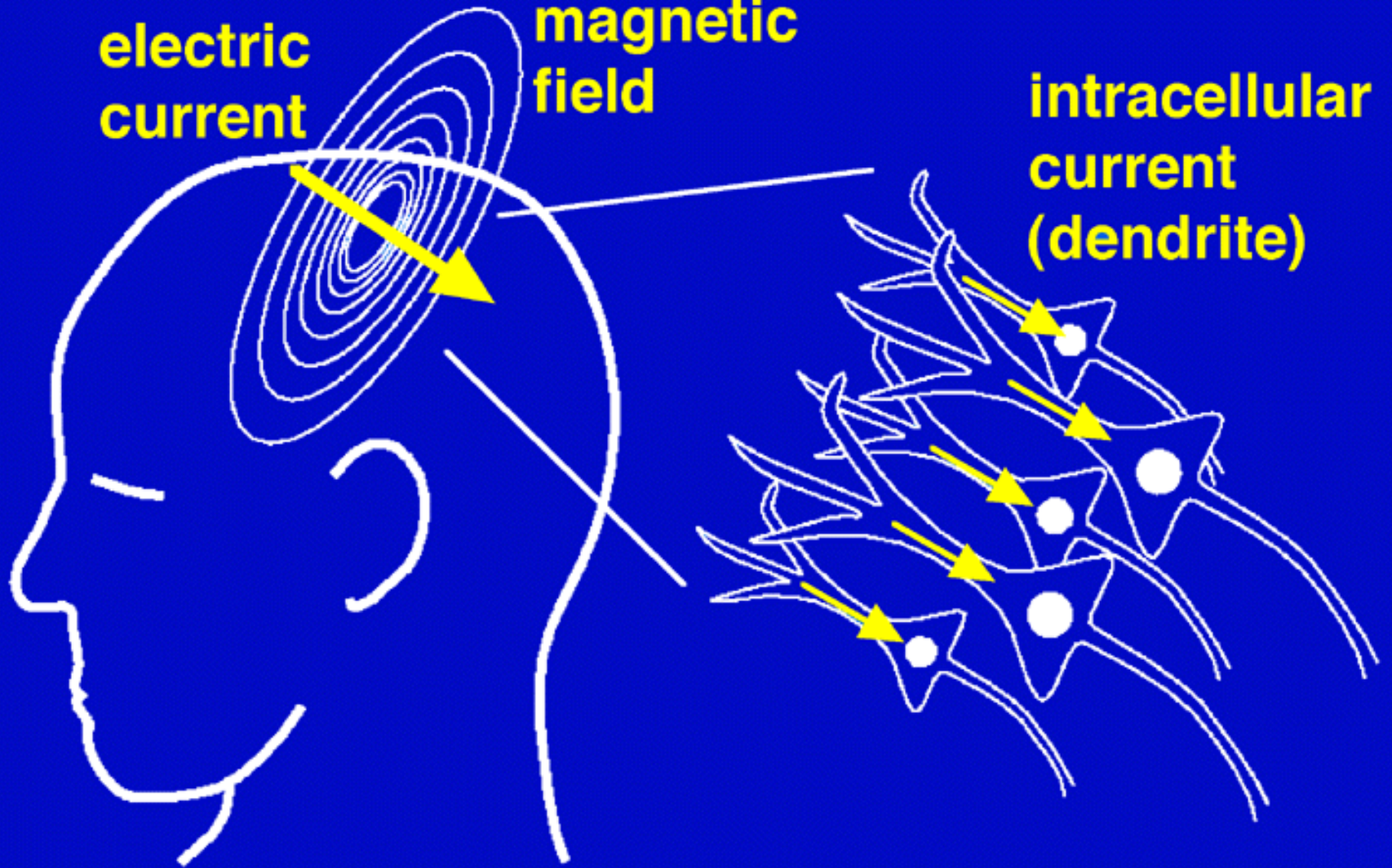

Magnetoencephalography (MEG)

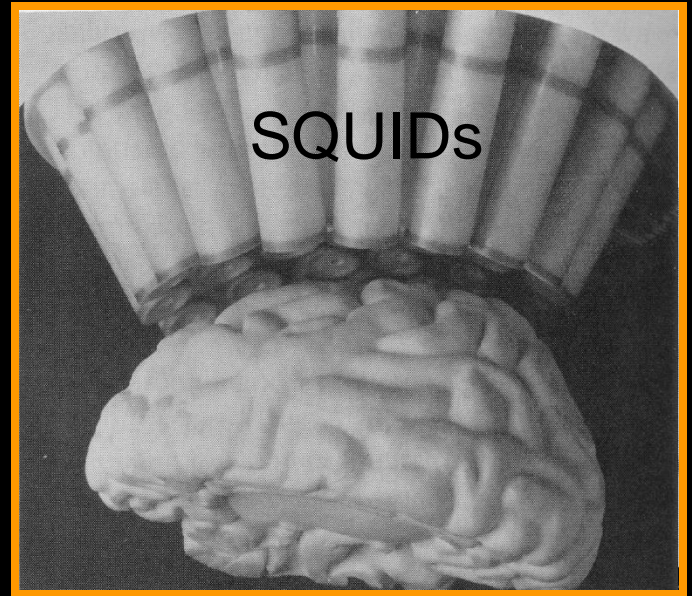
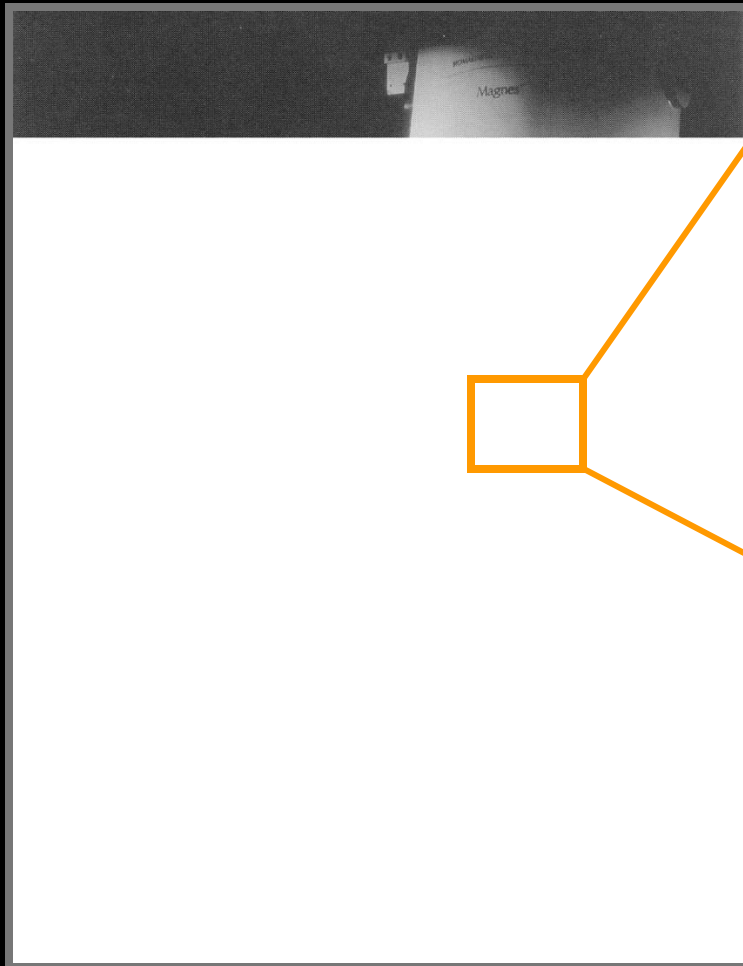

SQUID:
Superconducting Quantum
Interference Device

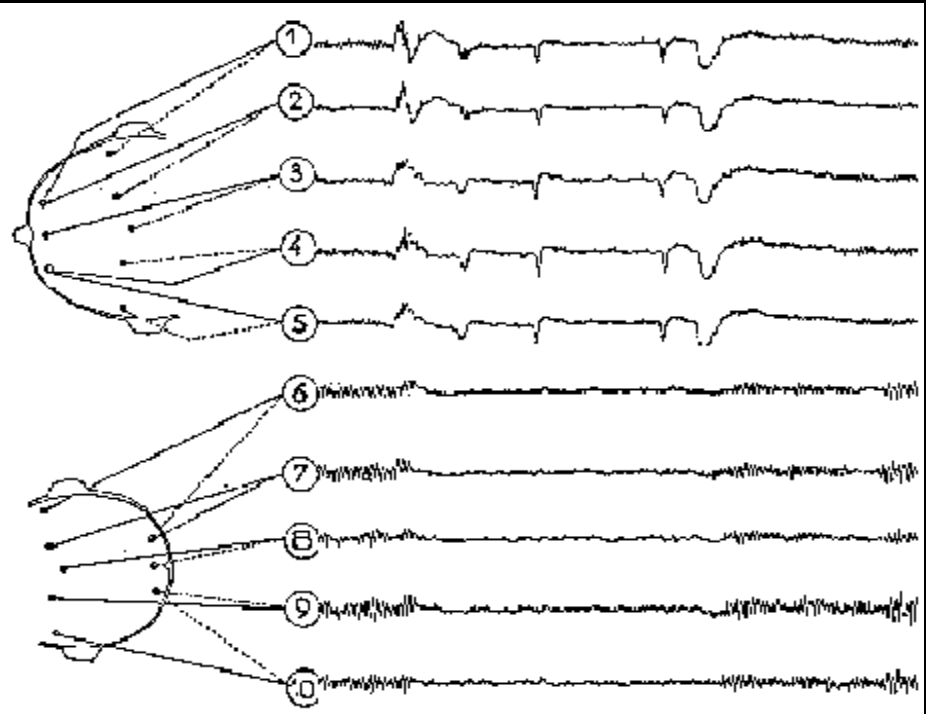

Alpha Wave Activity Mapped with MEG

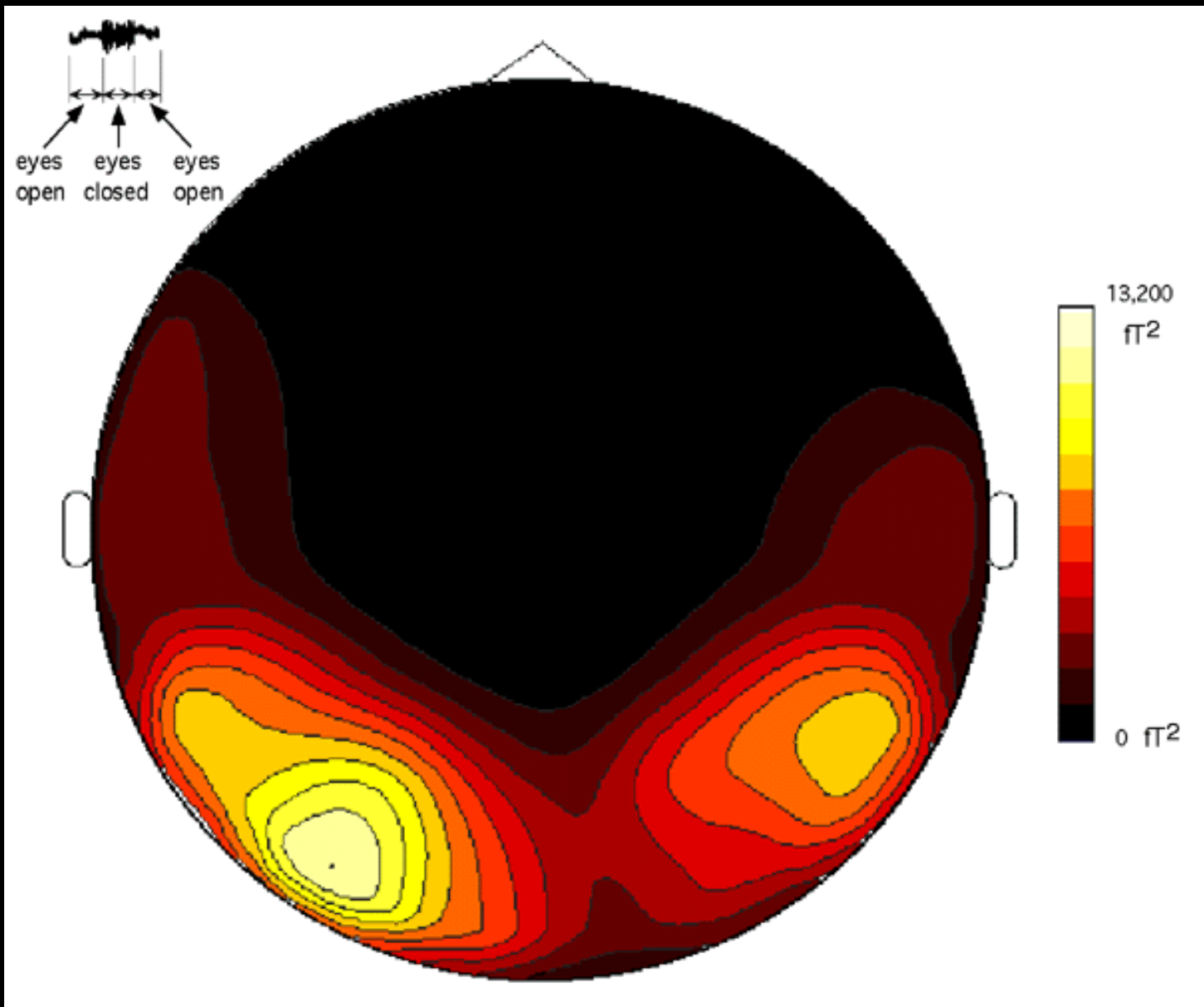

Functional Neuroimaging Techniques

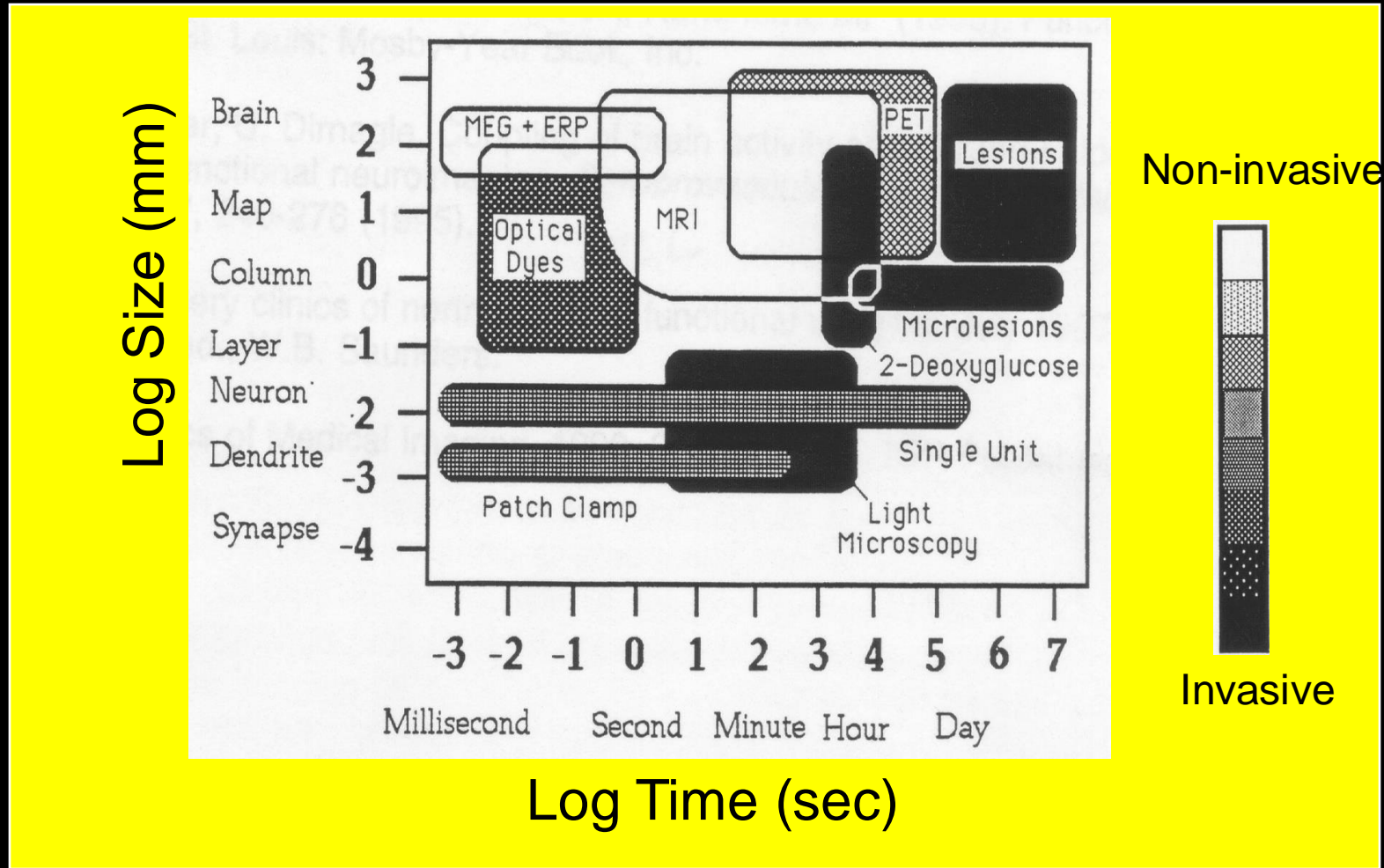

Transcranial Magnetic Stimulation

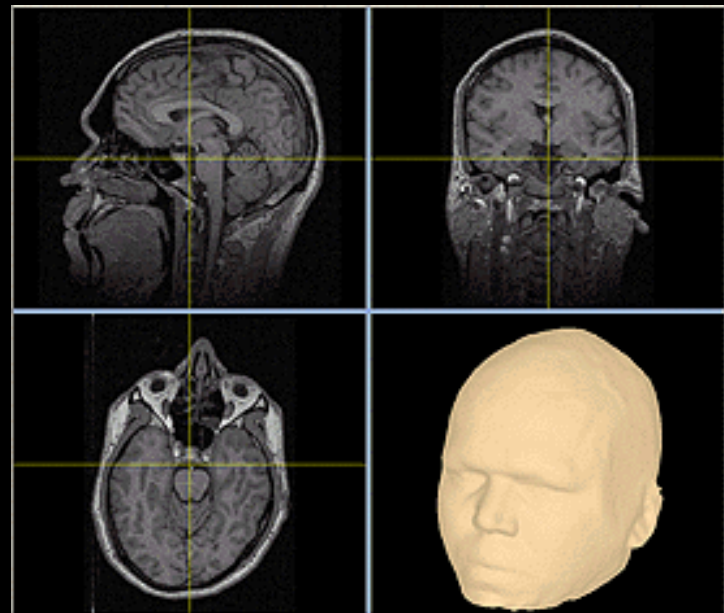

Transcranial Magnetic Stimulation (TMS)

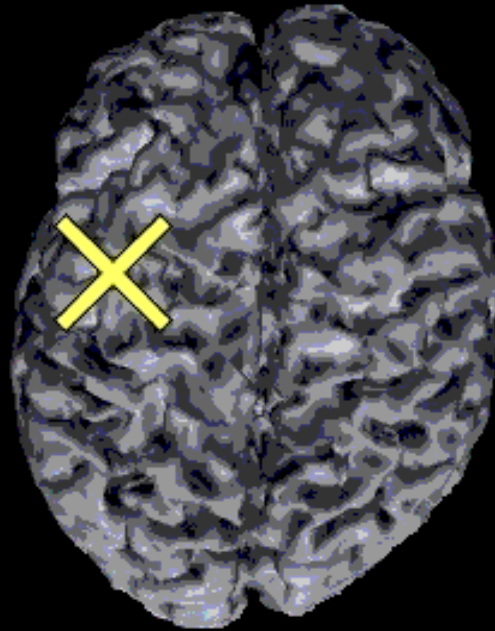

Section on Functional Imaging Methods & Functional MRI Facility Jan 19, 2007



Back row: **Wenming Luh**, **Niko Kriegeskorte**, **Rasmus Birn**, **Tyler Jones**, **Sean Marrett**

Middle row: **Jon West**, **Kay Kuhns**, **Anthony Boemio**, **Peter Bandettini**, **Joey Dunsmoor**, **Doug Ruff**, **Kevin Murphy**

Front row: **Dorian Van Tassel**, **Jerzy Bodurka**, **Adam Thomas**, **Marieke Mur**, **David Knight**