

# Meeting Highlights

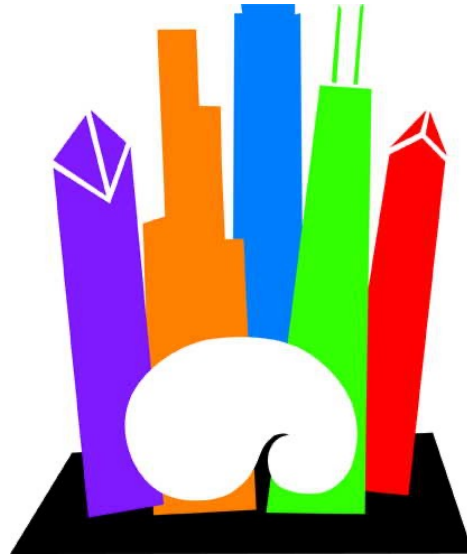

Human Brain Mapping 2007

Peter A. Bandettini

# OHBM 2007

- The Planning
- The Themes
- The Highlights

# OHBM 2007

- The Planning

- The Themes

- The Highlights

## Program Committee 2007

<b>Chair</b>	Christian Buechel
<b>Chair-Elect</b>	Keith Worsley
<b>Past Chair</b>	Maurizio Corbetta
<b>Members</b>	Tom Nichols Chair Education Subcommittee Paul Fletcher Andreas Kleinschmidt Riitta Salmelin Jean-Baptiste Poline Gian Luca Romani Vincent Clark Julien Doyon
<b>Ex-Officio Members</b>	Rainer Goebel John Mazziotta Peter Bandettini Marsel Mesulam Pietro Pietrini  Gary Egan

## Local Organizing Committee 2007

<b>Chair</b>	Marsel Mesulam Todd Parish Darren Gitelman Ken Paller Paul Reber  Cindy Thompson Steve Small Jia-Hong Gao Vania Apkarian Keith Thulborn
--------------	---



# First Program Committee Meeting (Florence)

Julien Doyon

John Mazziotta

Keith Worsley

Peter Bandettini

Vince Clark



Jia-Hong Gao

Gian Luca Romani

Lori Anderson

Tom Nichols

Julie Ratzloff

Christian Buechel

Riitta Salmelin



Marsel Mesulam

Andreas Kleinschmidt

Maurizio Corbetta

Pietro Pietrini

Cheryl Grady

Jean-Baptiste Poline



# Third Program Committee Meeting (Chicago)







# OHBM 2007

- The Planning

- The Themes

- The Highlights

Number of Abstracts

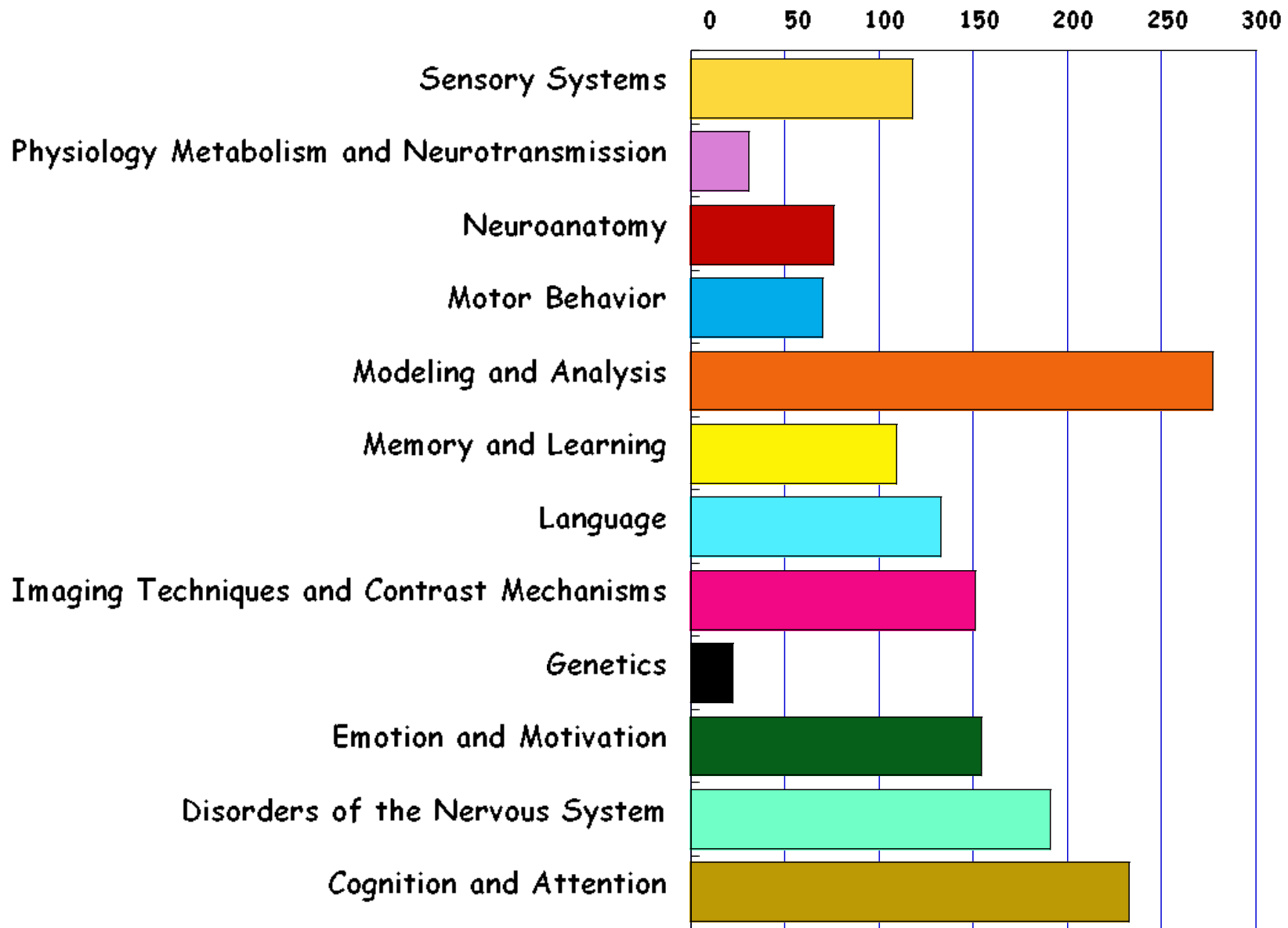

# Most popular sub-categories

Cognition and Attention	
-Executive Function	67
-Perception, imagery, awareness	53
-Attention (visual)	41
Emotion and Motivation	
-Emotional perception	66
Language	
-Comprehension	54
Modeling and Analysis	
-Functional connectivity	54
-Multivariate modeling, PCA,ICA	49
-Exploratory methods, artifact removal	41
Imaging Techniques	
-Functional MRI	49
Neuroanatomy	
-Anatomical Studies	48

## Other indicators of major themes this year

### Course Pre-Registrants:

Basic fMRI	45
Advanced fMRI	113
MEG/EEG	36
Cognitive Neuroscience	36
Structural Brain Mapping	72
Clinical fMRI	35

## Other categories that caught my attention

Classification, prediction

Individual clinical assessment

Resting state

Default mode

Multimodal integration



# OHBM 2007

- The Planning

- The Themes

- The Highlights

# My approach to this

- Ask for summary slide from authors of the top 65 abstracts.
- During the meeting, determine what gets my attention.
- Ask my colleagues to keep their eyes open.
- Take a few pictures.

SUNDAY JUNE 10		MONDAY JUNE 11	TUESDAY JUNE 12	WEDNESDAY JUNE 13	THURSDAY JUNE 14
<b>Educational Courses</b>					
		MORNING WORKSHOPS 8:00-9:15	MORNING WORKSHOPS 8:00-9:15	MORNING WORKSHOPS 8:00-9:15	MORNING WORKSHOPS 8:00-9:15
		LOC SYMPOSIUM 9:30-10:45	ORAL SESSIONS Imaging Techniques; Genetics; Disorders of the Nervous System 9:30-10:45	ORAL SESSIONS Imaging Techniques; Emotion and Motivation; Disorders of the Nervous System 9:30-10:45	ORAL SESSIONS Imaging Techniques; Cognition; Neuroanatomy 9:30-10:45
		KEYNOTE - Larry Squire 11:00-11:30	KEYNOTE - Mitsuo Kawato 11:00-11:30	KEYNOTE - Gary Glover 11:00-11:30	KEYNOTE - Maurizio Corbetta 11:00-11:30
		POSTER SESSION 11:30-12:30	POSTER SESSION 11:30-12:30	POSTER SESSION 11:30-12:30	POSTER SESSION 11:30-12:30
		LUNCH 12:30-13:45	LUNCH 12:30-13:45	LUNCH 12:30-13:45	LUNCH 12:30-13:45
		POSTER SESSION 13:45-14:45	POSTER SESSION 13:45-14:45	POSTER SESSION 13:45-14:45	POSTER SESSION 13:45-14:45
		SYMPOSIUM: Mapping Genetic Influences on Human Brain Structure and Function 15:00-16:15	SYMPOSIUM: A Multi-Level Perspective on the Neural Correlates of Perceptual Decision Making 15:00-16:15	SYMPOSIUM: Repetition and the Brain: From Neurons to Computational Models Using Multimodal Approaches 15:00-16:15	ORAL SESSIONS Modeling and Analysis; Cognition; Sensory Systems 15:00-16:15
		KEYNOTE - Brian Wandell 16:30-17:00	TOWN HALL MEETING 16:30 -17:00	KEYNOTE - Willem Levelt 16:30-17:00	MEETING HIGHLIGHTS: Peter Bandettini, Past Chair 16:30 - 17:30
		ORAL SESSIONS Modeling and Analysis; Memory; Disorders of the Nervous System 17:00 -18:15	KEYNOTE - Leah Krubitzer 17:00-17:30	ORAL SESSIONS Modeling and Analysis; Emotion and Motivation; Language 17:00 -18:15	FAREWELL RECEPTION 17:30-18:30
		POSTER RECEPTION 18:30-19:30	Motor Behavior 17:30 -18:45	POSTER RECEPTION 18:30-19:30	
			POSTER RECEPTION 19:00-20:00		
				CLUB NIGHT 21:00	
Basic fMRI Course 8:00-17:30					
Advanced fMRI Course 8:30-18:00					
Advanced MEG/EEG Course 8:00-18:00					
Cognitive Neuroscience Course 8:00-17:30					
Structural Brain Mapping Course 8:00-17:30					
OPENING CEREMONIES 18:30					
TALAIRACH LECTURE Daniel Kahneman					
WELCOME RECEPTION 19:30					

# Bernard Mazoyer



# Dan Kahneman



SUNDAY JUNE 10	MONDAY JUNE 11	TUESDAY JUNE 12	WEDNESDAY JUNE 13	THURSDAY JUNE 14
<b>Educational Courses</b>				
	MORNING WORKSHOPS 8:00-9:15	MORNING WORKSHOPS 8:00-9:15	MORNING WORKSHOPS 8:00-9:15	MORNING WORKSHOPS 8:00-9:15
	LOC SYMPOSIUM 9:30-10:45	ORAL SESSIONS Imaging Techniques; Genetics; Disorders of the Nervous System 9:30-10:45	ORAL SESSIONS Imaging Techniques; Emotion and Motivation; Disorders of the Nervous System 9:30-10:45	ORAL SESSIONS Imaging Techniques; Cognition; Neuroanatomy 9:30-10:45
	KEYNOTE - Larry Squire 11:00-11:30	KEYNOTE - Mitsuo Kawato 11:00-11:30	KEYNOTE - Gary Glover 11:00-11:30	KEYNOTE - Maurizio Corbetta 11:00-11:30
	POSTER SESSION 11:30-12:30	POSTER SESSION 11:30-12:30	POSTER SESSION 11:30-12:30	POSTER SESSION 11:30-12:30
	LUNCH 12:30-13:45	LUNCH 12:30-13:45	LUNCH 12:30-13:45	LUNCH 12:30-13:45
	POSTER SESSION 13:45-14:45	POSTER SESSION 13:45-14:45	POSTER SESSION 13:45-14:45	POSTER SESSION 13:45-14:45
	SYMPOSIUM: Mapping Genetic Influences on Human Brain Structure and Function 15:00-16:15	SYMPOSIUM: A Multi-Level Perspective on the Neural Correlates of Perceptual Decision Making 15:00-16:15	SYMPOSIUM: Repetition and the Brain: From Neurons to Computational Models Using Multimodal Approaches 15:00-16:15	ORAL SESSIONS Modeling and Analysis; Cognition; Sensory Systems 15:00-16:15
	KEYNOTE - Brian Wandell 16:30-17:00	TOWN HALL MEETING 16:30 -17:00	KEYNOTE - Willem Levelt 16:30-17:00	MEETING HIGHLIGHTS: Peter Bandettini, Past Chair 16:30 - 17:30
	ORAL SESSIONS Modeling and Analysis; Memory; Disorders of the Nervous System 17:00 -18:15	KEYNOTE - Leah Krubitzer 17:00-17:30	ORAL SESSIONS Modeling and Analysis; Emotion and Motivation; Language 17:00 -18:15	FAREWELL RECEPTION 17:30-18:30
	POSTER RECEPTION 18:30-19:30	Motor Behavior 17:30 -18:45	POSTER RECEPTION 18:30-19:30	
		POSTER RECEPTION 19:00-20:00		
			CLUB NIGHT 21:00	
OPENING CEREMONIES 18:30				
TALAIRACH LECTURE Daniel Kahneman				
WELCOME RECEPTION 19:30				

Basic fMRI Course 8:00-17:30

Advanced fMRI Course 8:30-18:00

Advanced MEG/EEG Course 8:00-18:00

Cognitive Neuroscience Course 8:00-17:30

Structural Brain Mapping Course 8:00-17:30

# LOC Symposium: Imaging the Structural Connectivity of the Cerebral Cortex

Jeremy Schmahmann, MGH

Heidi Johansen-Berg, Oxford

Marco Catani, UCL

# Validation of tractography: Comparison with manganese tracer results in PF

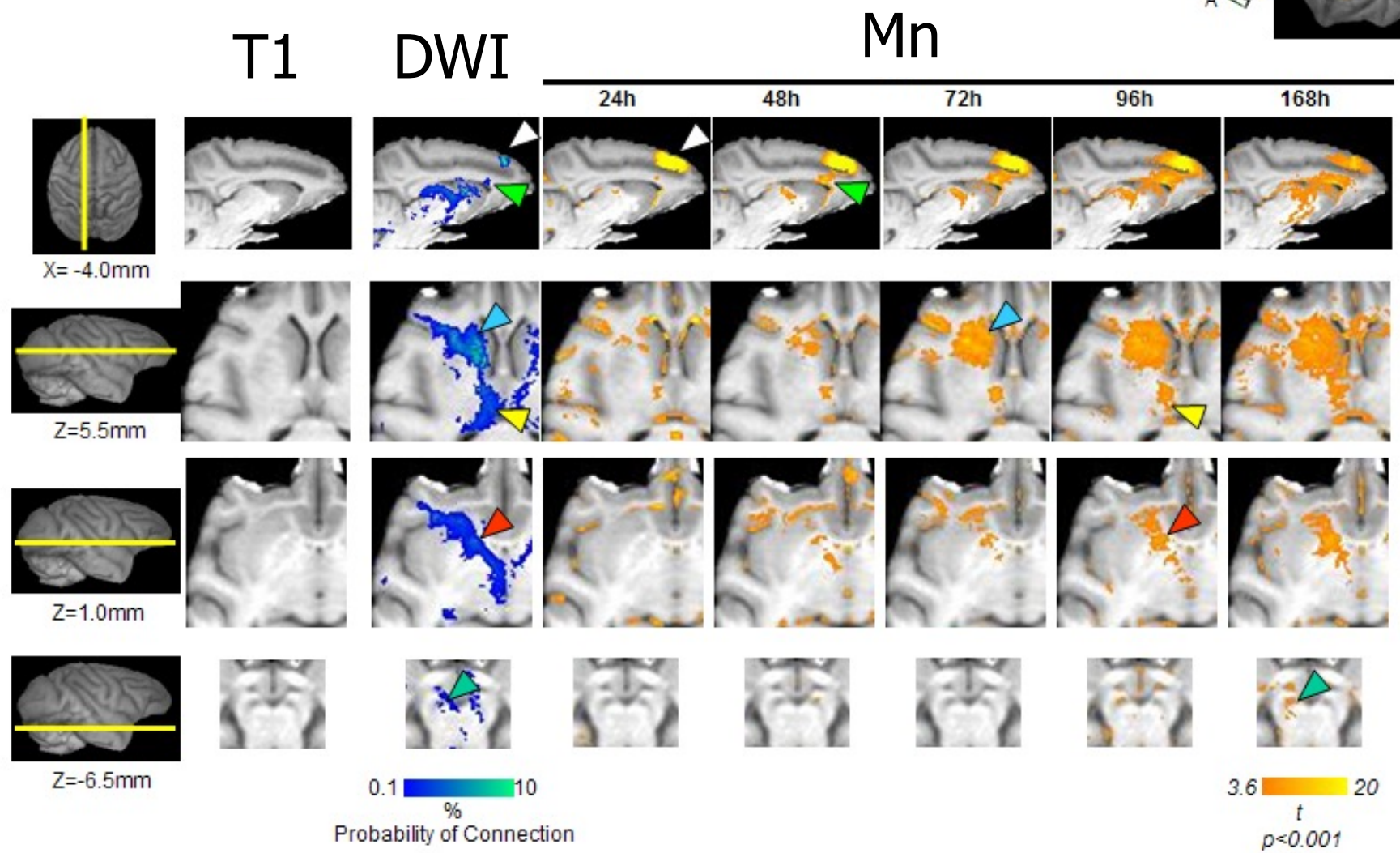
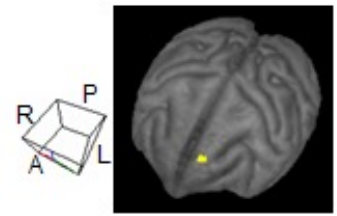



# Anatomical correlates of right-hemispheric language processing: A DTI study

Monday – AM

S Mohammadi, A Jansen, W Schwindt, S Knecht, M Deppe  
University of Münster, Germany

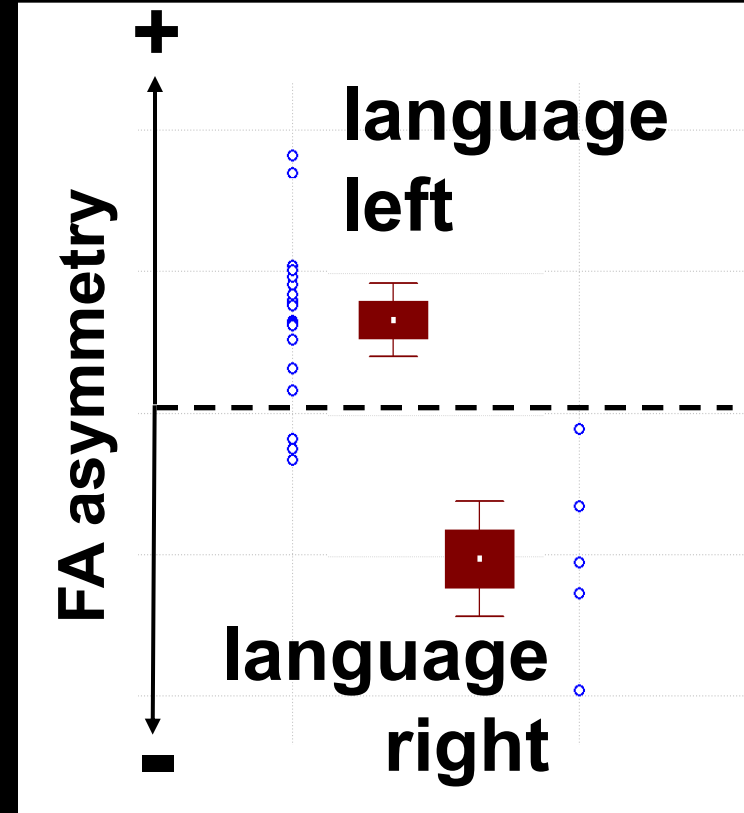
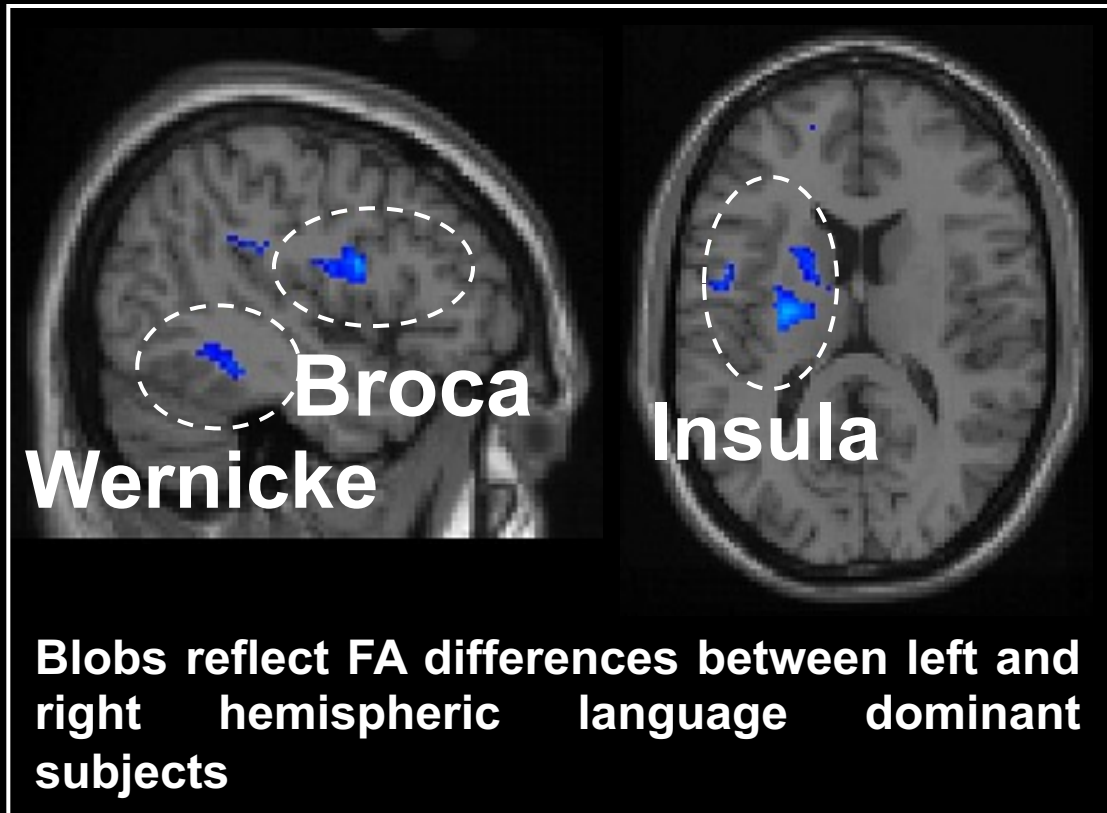

**Results: language dominance was predicted by hemispheric FA asymmetry**



# Does callosal thickness correlate with intelligence?

- (1) Intelligence and callosal thickness are correlated.
- (2) Only positive correlations are significant.
- (3) Positive correlations are most pronounced in the posterior half of the corpus callosum.

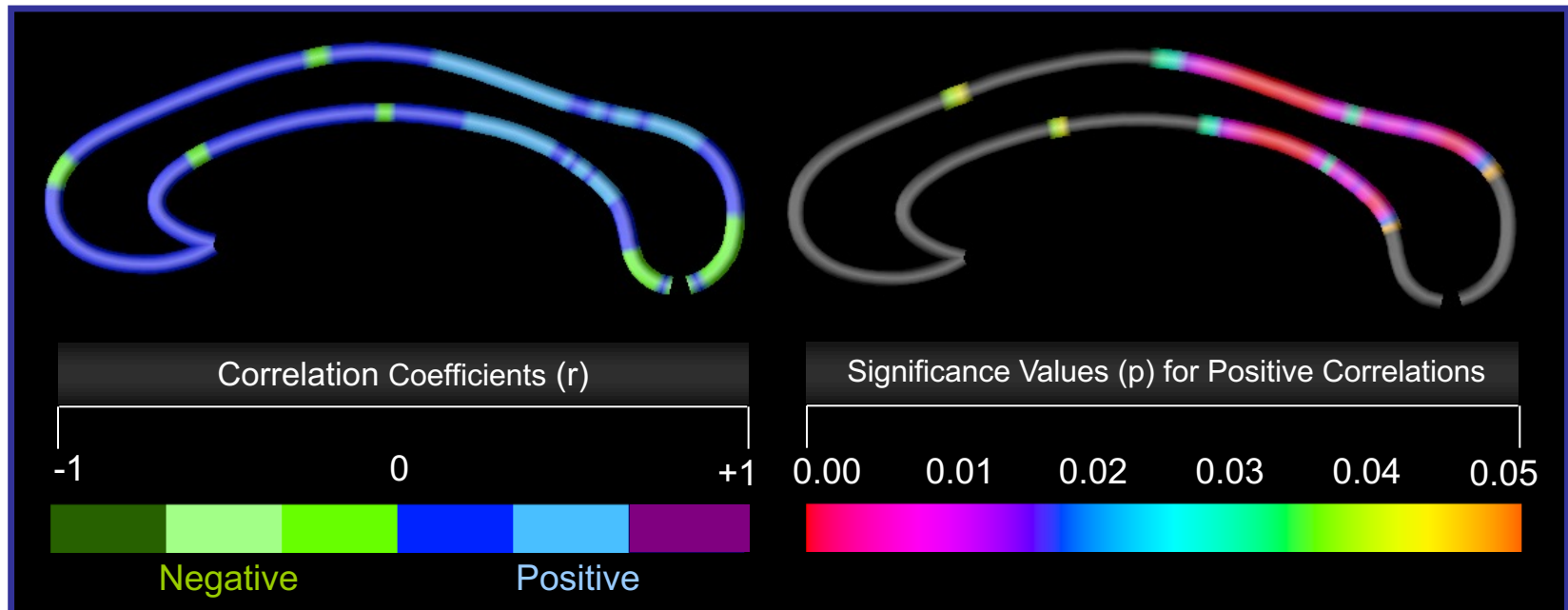

# More Accurate Talairach Coordinates for Neuroimaging



Cheryl M. Lacadie<sup>1</sup>, Robert K. Fulbright<sup>1</sup>,  
R. Todd Constable<sup>1,2</sup>, Xenophon Papademetris<sup>1,2</sup>

<sup>1</sup>Department of Diagnostic Radiology and <sup>2</sup>Biomedical Engineering, Yale University

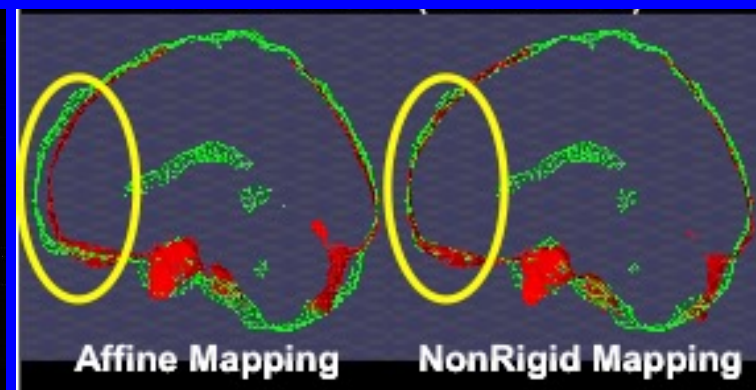
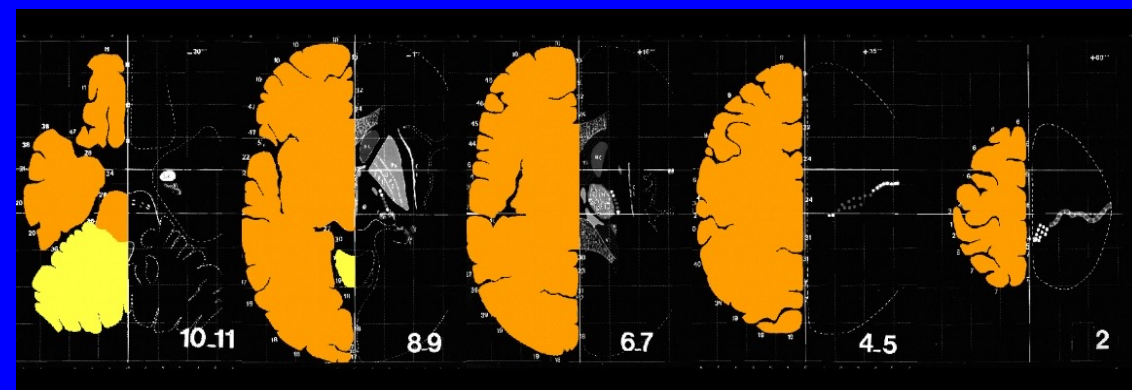

MNI to Talairach Coordinate Converter

Yale Nonlinear MNI -> TAL

**Part of BioImage Suite software.**  
**Also java applet available online at**  
[www.bioimagesuite.org](http://www.bioimagesuite.org)

- Created a 3D Talairach brain surface by scanning the original atlas and stacking and segmenting the slices.
- Non-linearly registered this surface to MNI template outer brain surface to compute a true non-linear MNI2TAL registration

# Cerebellar and posterior parietal involvement in the integration of visual and proprioceptive feedback during stabilization of the wrist

A.J. Suminski<sup>1</sup>, S.M. Rao<sup>2</sup>, and R.A. Scheidt<sup>1</sup>

<sup>1</sup>Marquette Univ., Milwaukee, WI; <sup>2</sup>Medl College of Wisconsin, Milwaukee, WI

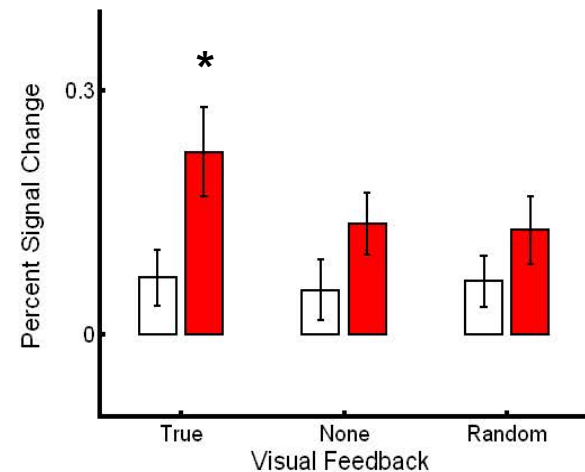
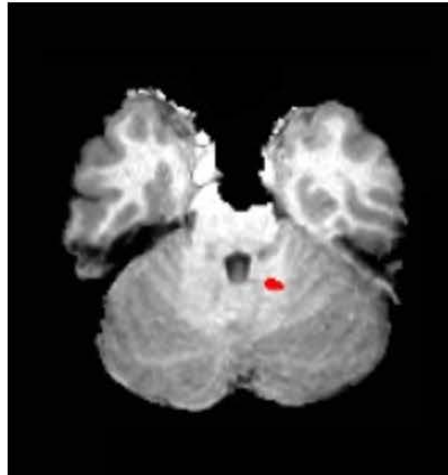
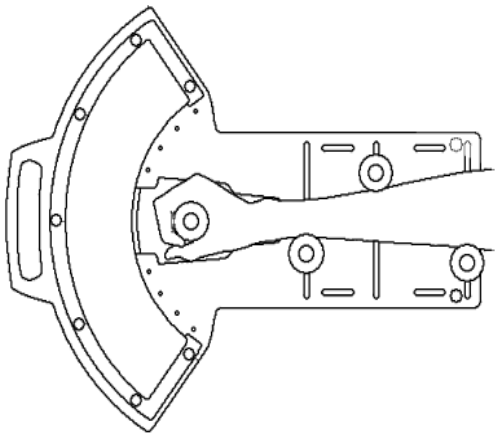

Activation in the **ipsilateral dentate nucleus** is **enhanced** when visual and proprioceptive feedback are **correlated** in time.

Reflective of it's role in **integrating multiple sensory and feedforward estimates of limb state** thereby producing a unified limb state estimate that can be used to correct for movement errors.

# Gamma power is phase-locked to posterior alpha activity

Daria Osipova, Ali Mazaheri, Ole Jensen

F.C. Donders Centre for Cognitive Neuroimaging, Nijmegen, the Netherlands

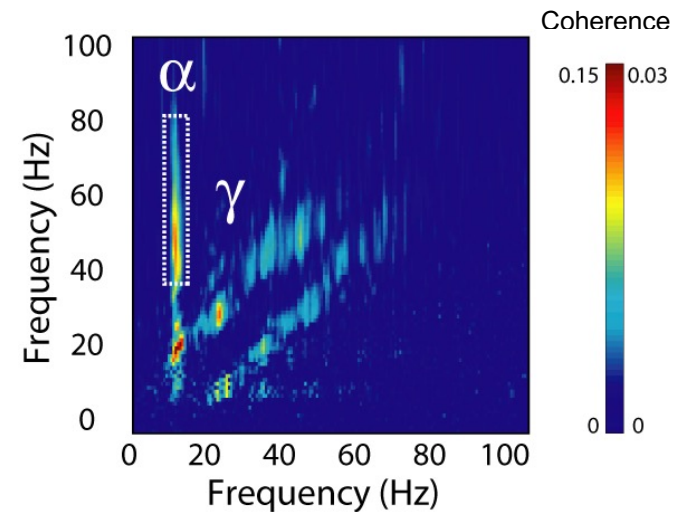
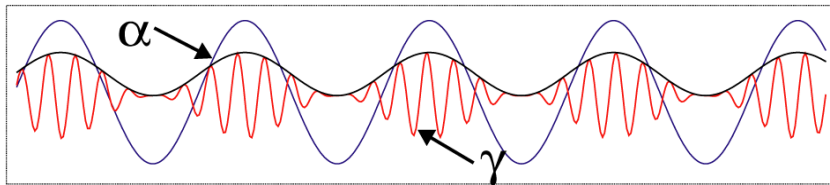

This finding suggests that visual processing reflected by gamma activity (40-100 Hz) is chunked in time determined by the alpha (8-13 Hz) phase.

Poster # 37, Monday morning



# Electrophysiological Recordings and High-Resolution Imaging of Human Hippocampus Reveal Couplings between BOLD Activations, Local Field Potentials, and Cellular Firing Rate

Arne Ekstrom, Nanthia Suthana, Itzhak Fried, and Susan Bookheimer

UCLA Center For Cognitive Neuroscience and Dept of Neurosurgery

#179 Mon.-PM Memory Session

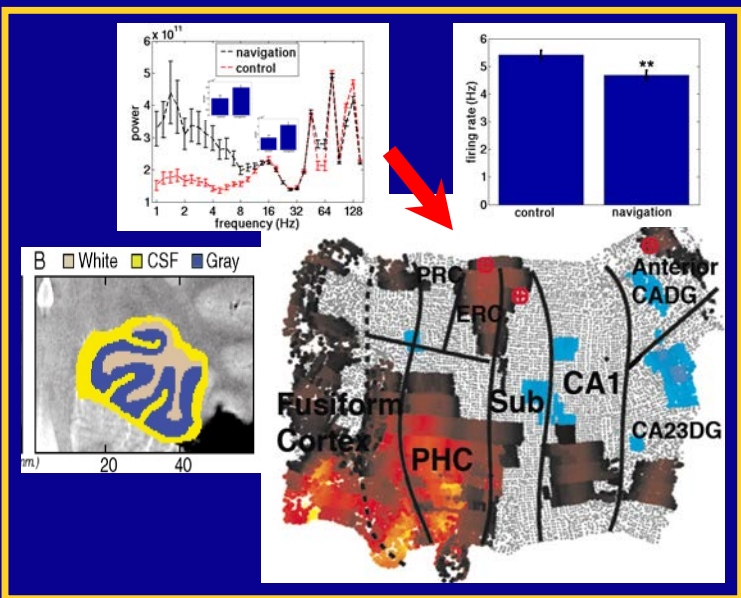
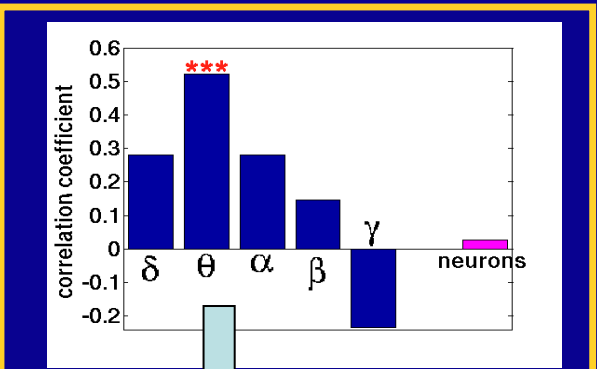
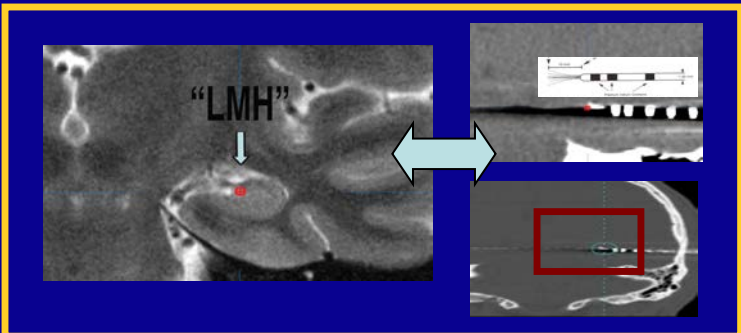

Magnitude of Hippocampal BOLD Activation Correlates With  $\theta$  Oscillations

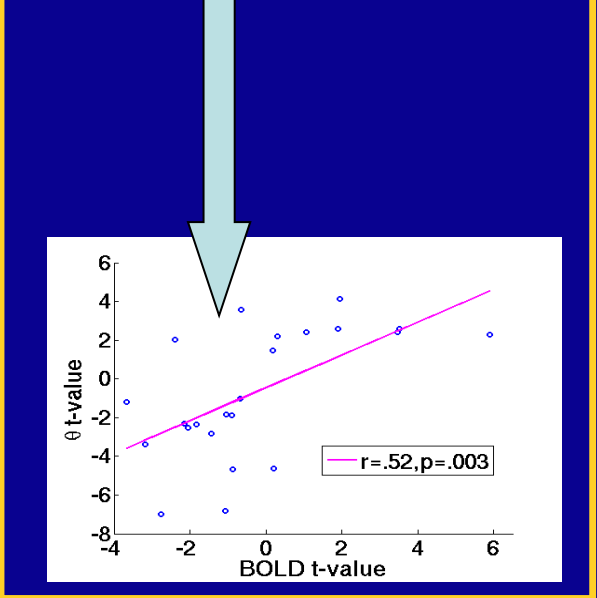



# Keynote: Brain Wandell

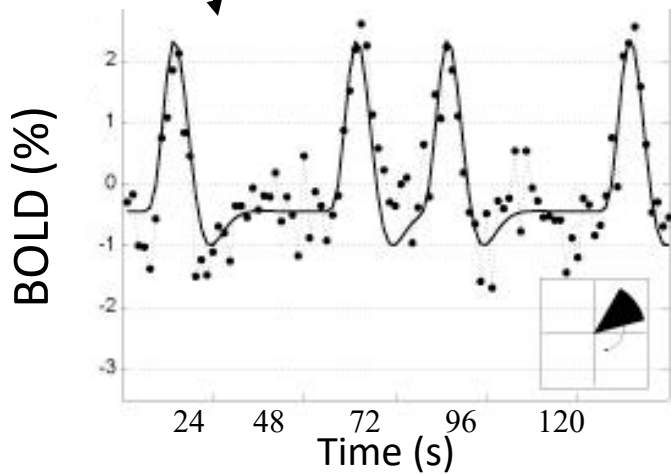
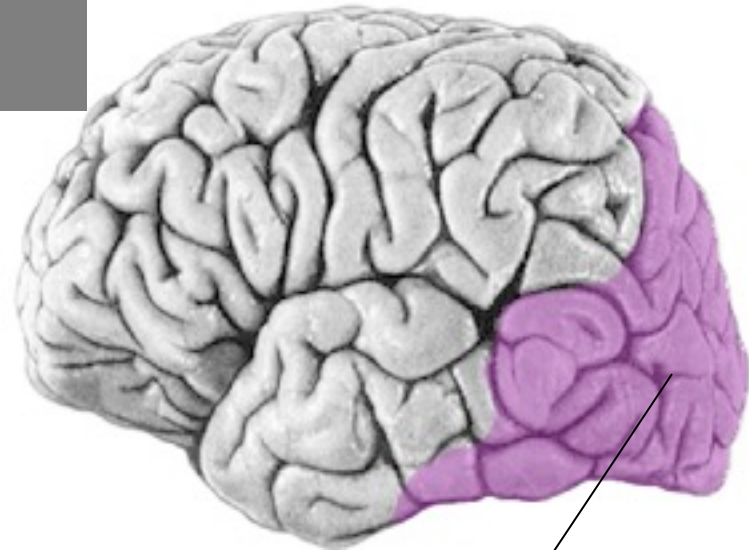
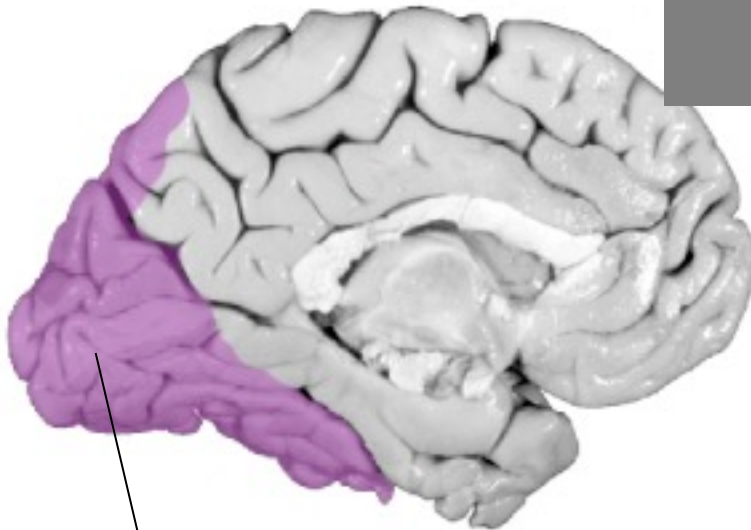
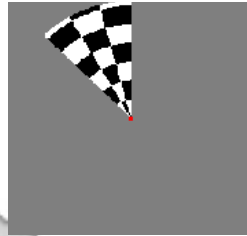

Different

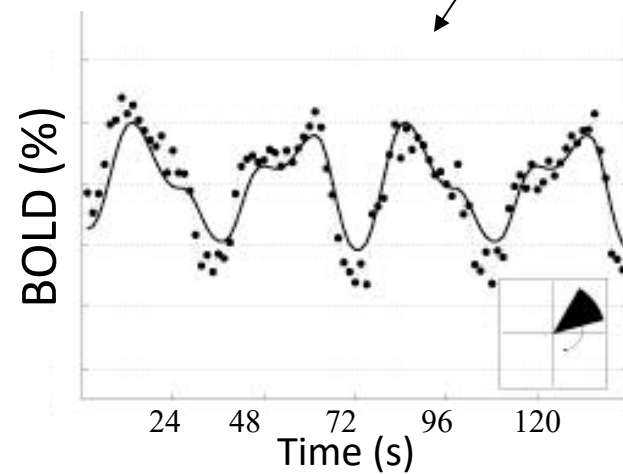

# Calibration of BOLD fMRI signal changes using cued and spontaneous breathing variations

R.M. Birn, T.B. Jones, P.A. Bandettini

Section on Functional Imaging Methods, Lab of Brain and Cognition, NIMH, NIH

## Correlation between Respiration-induced and BOLD signal changes

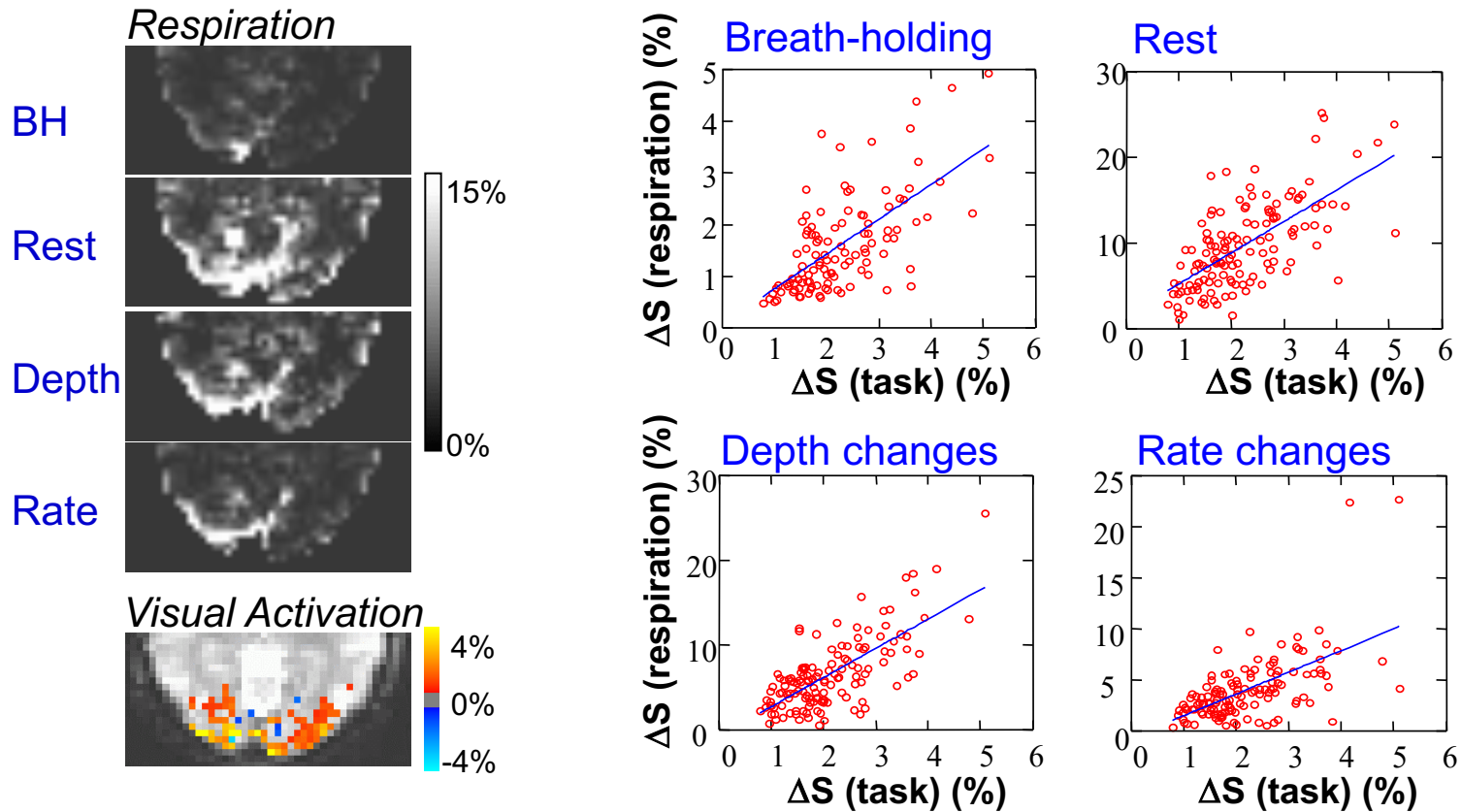

# Symposium: Mapping Genetic Influences on Human Brain Structure and Function

Richard Frackowiak, UCL  
Daniel Weinberger, NIMH  
David Eidelberg, LIJ Health System



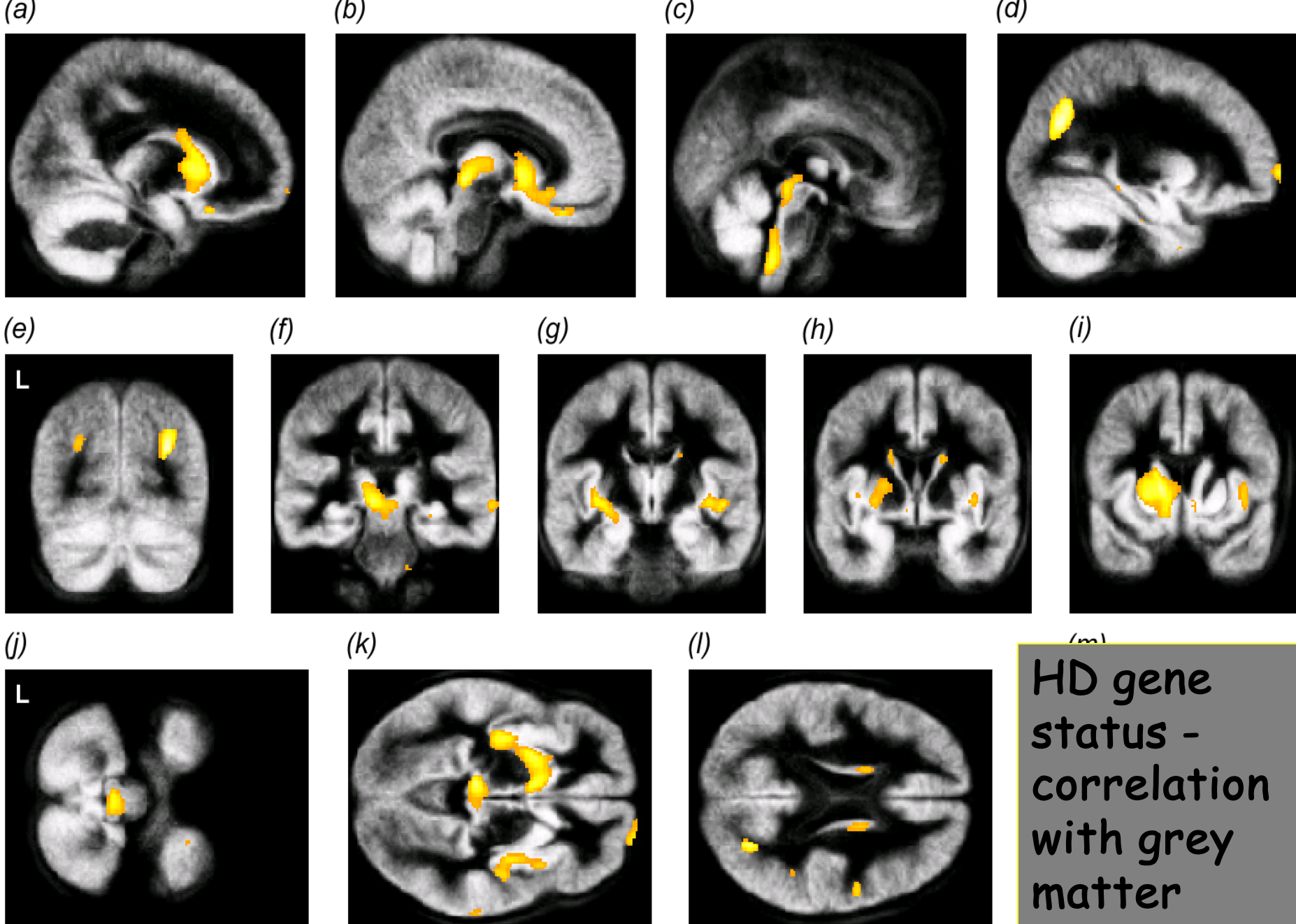

**Structural biomarkers of preclinical disease**

# The path from here to there...

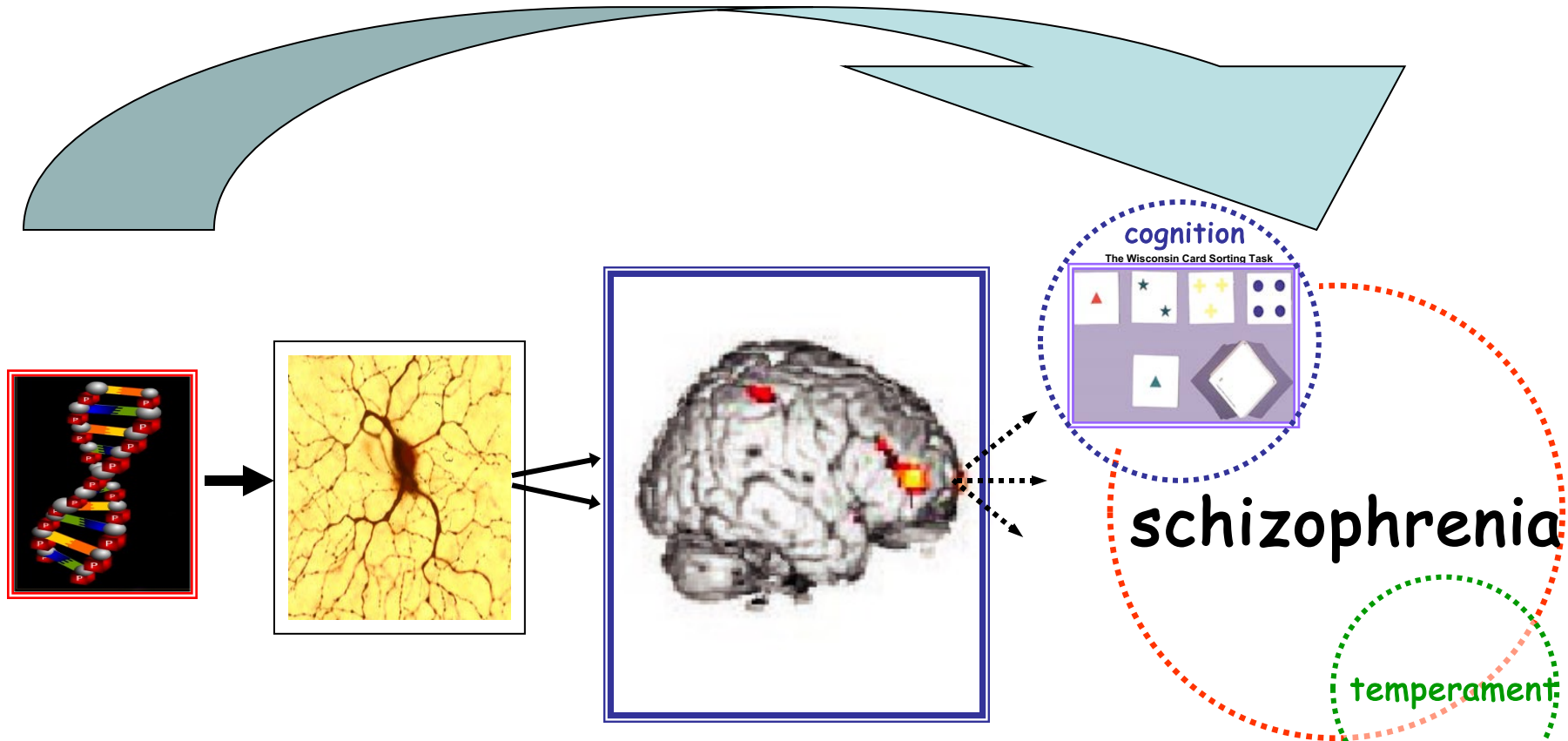

## Genes:

*multiple  
susceptibility  
alleles each of  
small effect*

## Cells:

*subtle  
molecular  
abnormalities*

## Systems:

*abnormal  
information  
processing*

## Behavior:

*complex functional  
interactions and  
emergent  
phenomena*

# Mean diffusivity: A biomarker for CSF-related disease and genetic liability effects in schizophrenia

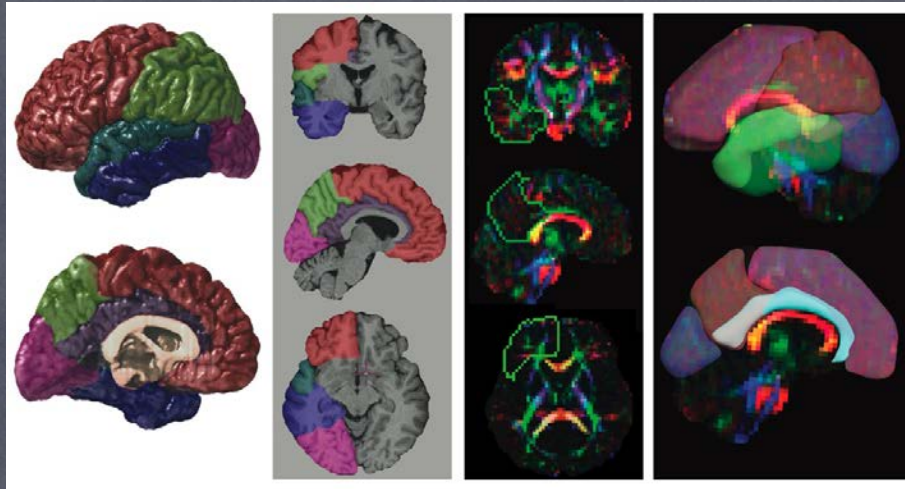

Mean diffusivity and CSF volume are highly correlated, suggesting these measures reflect the same underlying pathophysiological processes in schizophrenia.

Mean diffusivity and CSF volume relationships, and disease and schizophrenia genetic liability effects were examined using a regions of interest approach applied to DTI and structural MR data.

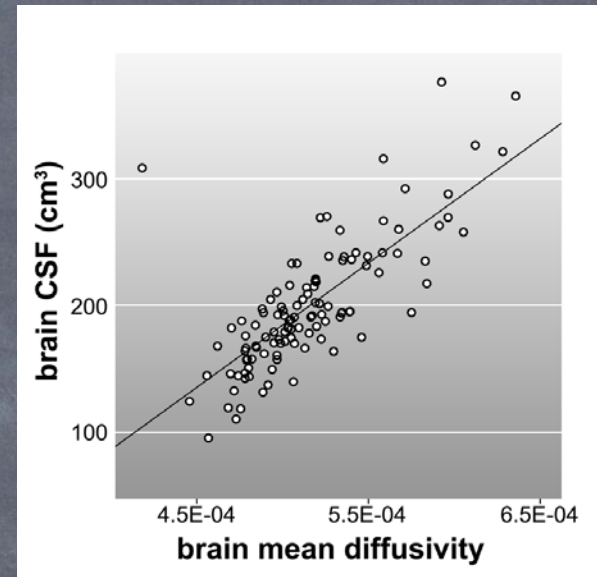
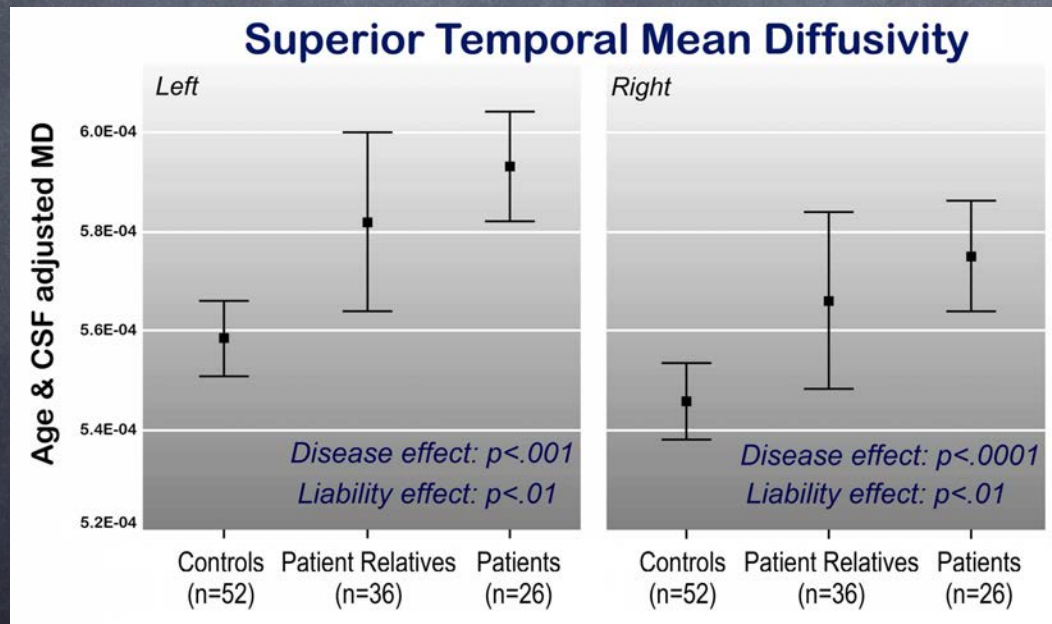

Mean diffusivity appears a sensitive biological marker of disease and genetic liability in schizophrenia that characterizes at least partially distinct aspects of brain structural integrity.



# Functional Perfusion and BOLD MRI in Alzheimer's Disease Genetic Risk

Adam Fleisher et al, UCSD

Poster #111 TH-AM

Oral presentation: Monday pm: Memory

Activation Perfusion

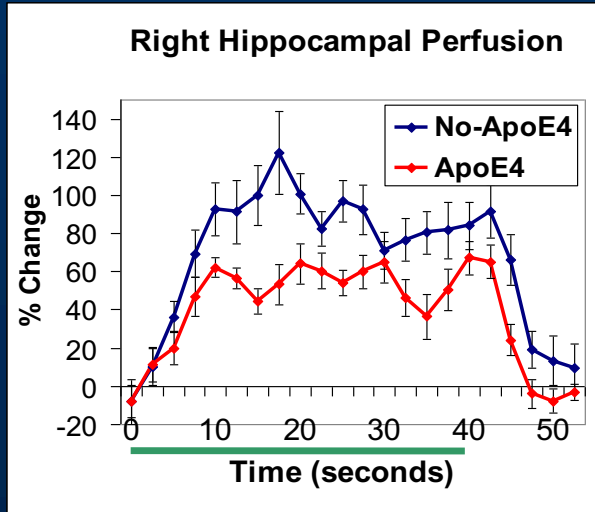

Activation BOLD

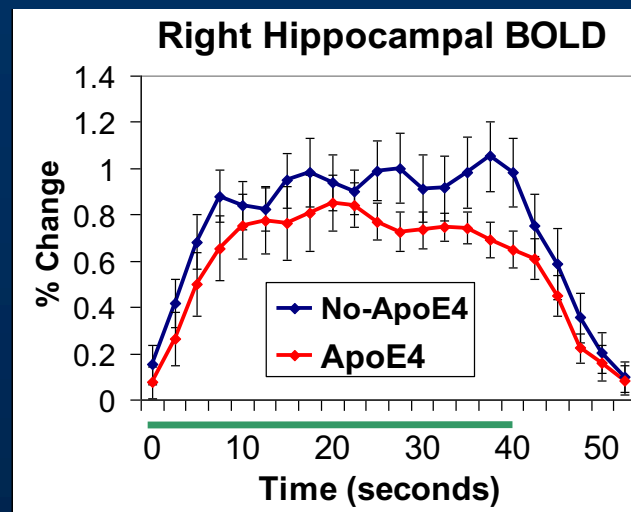

Resting Perfusion state

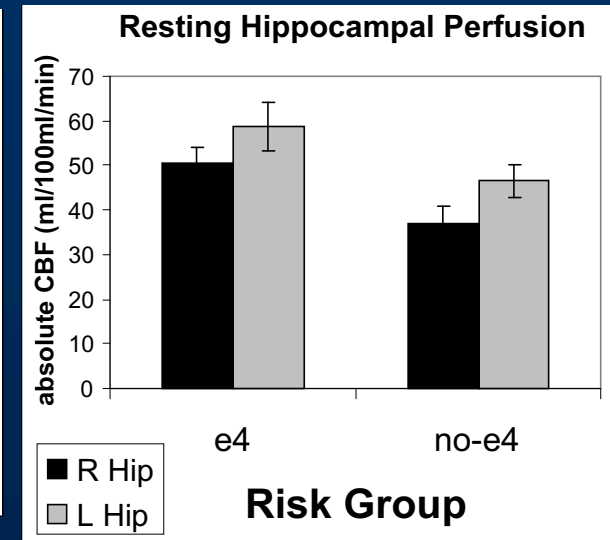

## Results:

Decreased **BOLD** and **perfusion** signal activation in middle aged APOE4 carriers in the MTL during the memory task.

- APOE-e4 carriers had an elevated state of baseline perfusion which likely influences activation differences.



# BOLD communication: When the brain speaks for itself

Bettina Sorger, Brigitte Dahmen, Joel Reithler, Rainer Goebel

Cognitive Neuroscience Department, Maastricht University, The Netherlands  
Maastricht Brain Imaging Center (M-BIC), Maastricht University, The Netherlands

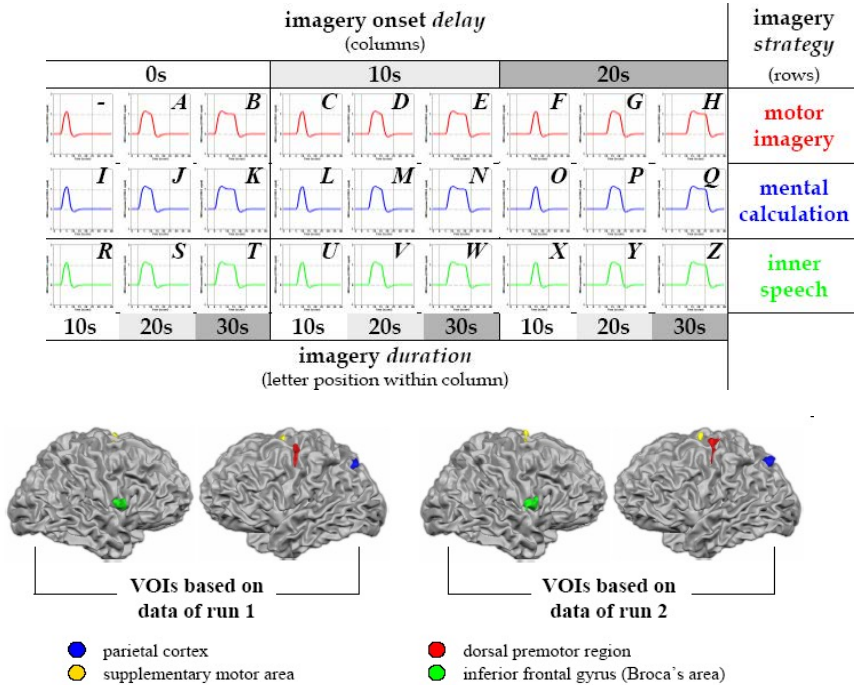

en-/decoder	guided letter encoding				phrase encoding			
	paradigm	delay	duration	letter	paradigm	delay	duration	letter
S1	.988	.981	.907	.889	.958	.986	.889	.840
S2	.938	.932	.870	.827	.784	.961	.804	.686
S3	.957	.981	.920	.883	.735	.931	.824	.608
R1	.966	.975	.932	.901	.869	.960	.869	.778
R2	.969	.957	.907	.877	.879	.990	.889	.788
R3	.944	.963	.858	.821	.800	.940	.798	.636
total	.961	.965	.899	.866	.852	.963	.852	.734

Fig. 3. Accuracy results of the *guided letter* and *phrase encoding* experiments (percentage of correct identification).

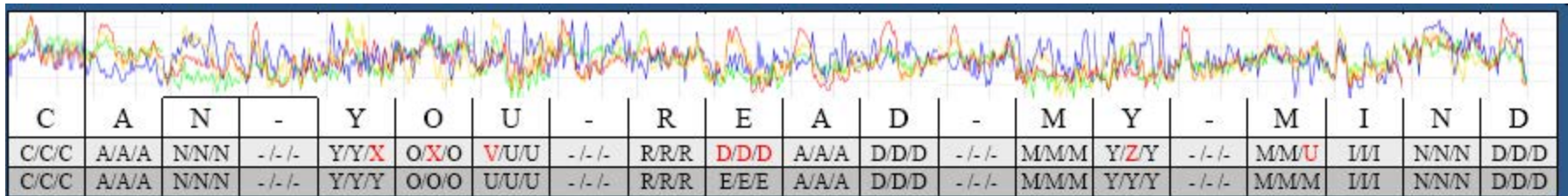

Fig. 4. Results of the *phrase encoding* experiment (subject S1).

The first row displays the single-trial time courses of the four VOIs generated by the subject while encoding the letters indicated in the second row. The third (light-grey) row displays letter decoding results obtained independently by three raters (R1/R2/R3) evaluating the time courses in randomized trial order (without word context information), whereas the fourth (dark-grey) row illustrates the results obtained by using the original trial order (providing word context information).

SUNDAY JUNE 10		MONDAY JUNE 11	TUESDAY JUNE 12	WEDNESDAY JUNE 13	THURSDAY JUNE 14
<b>Educational Courses</b>					
		MORNING WORKSHOPS 8:00-9:15	MORNING WORKSHOPS 8:00-9:15	MORNING WORKSHOPS 8:00-9:15	MORNING WORKSHOPS 8:00-9:15
		LOC SYMPOSIUM 9:30-10:45	ORAL SESSIONS Imaging Techniques; Genetics; Disorders of the Nervous System 9:30-10:45	ORAL SESSIONS Imaging Techniques; Emotion and Motivation; Disorders of the Nervous System 9:30-10:45	ORAL SESSIONS Imaging Techniques; Cognition; Neuroanatomy 9:30-10:45
		KEYNOTE - Larry Squire 11:00-11:30	KEYNOTE - Mitsuo Kawato 11:00-11:30	KEYNOTE - Gary Glover 11:00-11:30	KEYNOTE - Maurizio Corbetta 11:00-11:30
		POSTER SESSION 11:30-12:30	POSTER SESSION 11:30-12:30	POSTER SESSION 11:30-12:30	POSTER SESSION 11:30-12:30
		LUNCH 12:30-13:45	LUNCH 12:30-13:45	LUNCH 12:30-13:45	LUNCH 12:30-13:45
		POSTER SESSION 13:45-14:45	POSTER SESSION 13:45-14:45	POSTER SESSION 13:45-14:45	POSTER SESSION 13:45-14:45
		SYMPOSIUM: Mapping Genetic Influences on Human Brain Structure and Function 15:00-16:15	SYMPOSIUM: A Multi-Level Perspective on the Neural Correlates of Perceptual Decision Making 15:00-16:15	SYMPOSIUM: Repetition and the Brain: From Neurons to Computational Models Using Multimodal Approaches 15:00-16:15	ORAL SESSIONS Modeling and Analysis; Cognition; Sensory Systems 15:00-16:15
		KEYNOTE - Brian Wandell 16:30-17:00	TOWN HALL MEETING 16:30 -17:00	KEYNOTE - Willem Levelt 16:30-17:00	MEETING HIGHLIGHTS: Peter Bandettini, Past Chair 16:30 - 17:30
		ORAL SESSIONS Modeling and Analysis; Memory Disorders of the Nervous System 17:00 -18:15	KEYNOTE - Leah Krubitzer 17:00-17:30	ORAL SESSIONS Modeling and Analysis; Emotion and Motivation; Language 17:00 -18:15	FAREWELL RECEPTION 17:30-18:30
		ORAL SESSIONS Modeling and Analysis; Cognition; 17:00 -18:15	ORAL SESSIONS Modeling and Analysis; Cognition; 17:00 -18:15	ORAL SESSIONS Modeling and Analysis; Emotion and Motivation; Language 17:00 -18:15	ORAL SESSIONS Modeling and Analysis; Cognition; Sensory Systems 15:00-16:15
OPENING CEREMONIES 18:30		POSTER RECEPTION 18:30-19:30	Motor Behavior 17:30 -18:45	POSTER RECEPTION 18:30-19:30	
TALAIRACH LECTURE Daniel Kahneman		POSTER RECEPTION 19:00-20:00	POSTER RECEPTION 19:00-20:00		
WELCOME RECEPTION 19:30				CLUB NIGHT 21:00	

# Maturation increase noise in single trial EEG data relates to behavior stabilisation

AR McIntosh

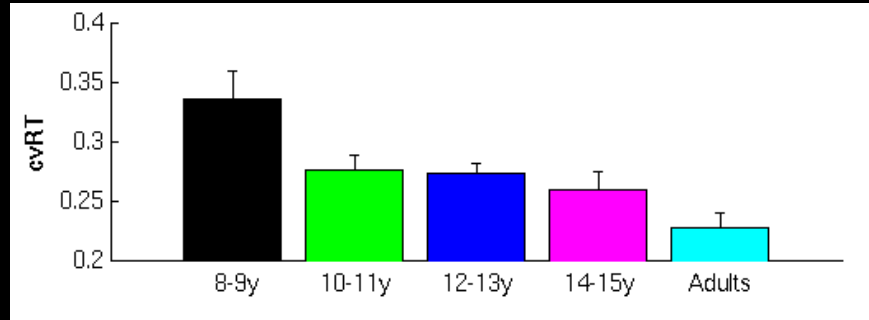

Coefficient of Variation in RT  
Higher variability in children

Negative correlation  
of brain variability  
and behaviour  
variability

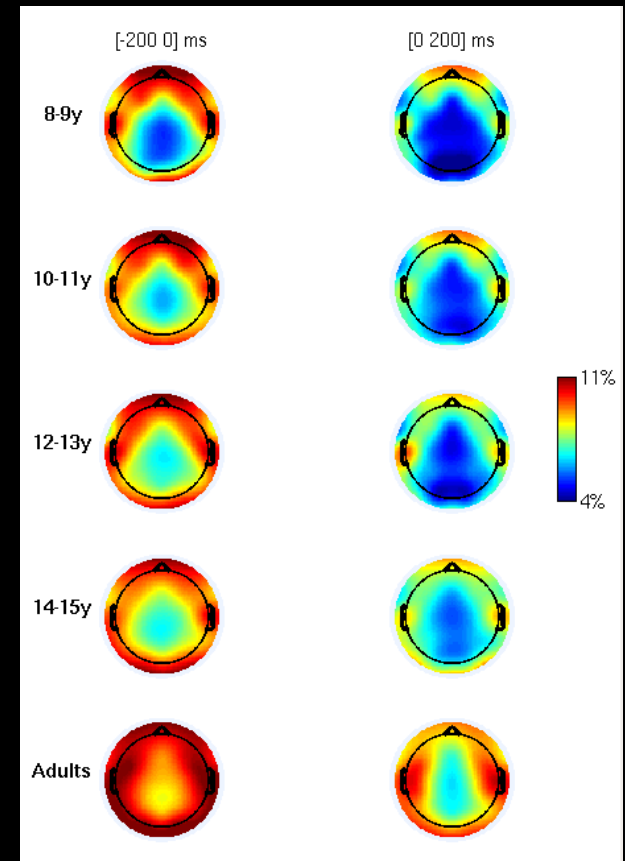
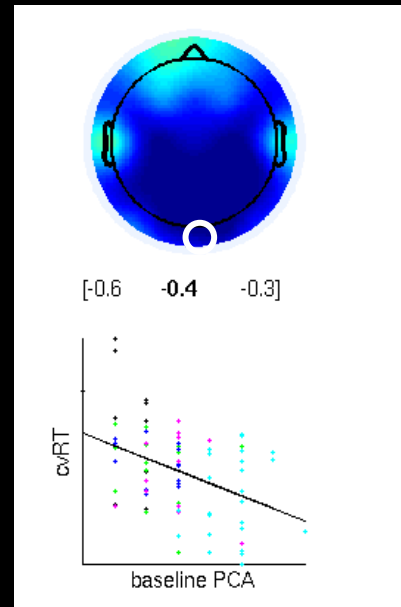

PCA dimensionality  
Increased dimensionality  
(brain variability) with  
maturation

Brain Noise: The new buzz:  
Breakspear, Jirsa, Harrison & McIntosh, Chair:Friston

# The VETSA Study: Heritability of Cortical Thickness

Lars M. Rimol et al., UCSD

Oral presentation: Tuesday AM - 9:45

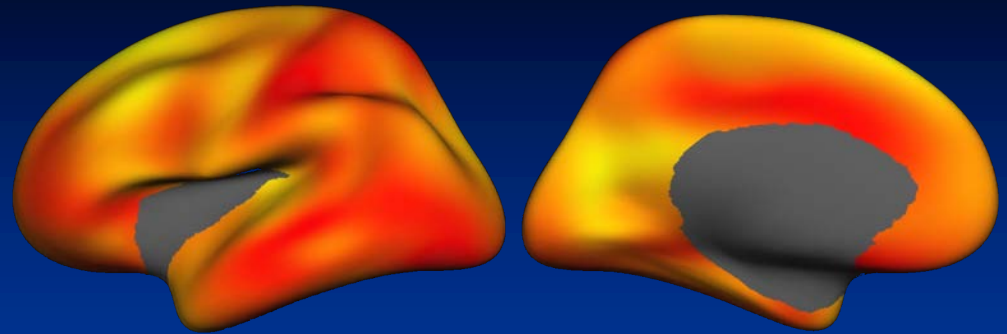

Lighter colors indicate higher heritabilities

- Elucidating patterns of genetic and environmental influences is important for understanding brain morphometry, and for identifying promising regions for gene association studies.
- This requires large twin studies (present sample = 157 twin pairs)
- Heritabilities were 60-70% in dorsal frontal lobe, premotor and motor cortex, and the medial occipital lobe suggesting that these would be most promising for gene association analyses.
- Heritabilities were 30-50% in lateral temporal lobe and middle cingulate gyrus, indicating that up to 70% of variance in some of these regions was explained by environmental factors.
- Broca's and Wernicke's areas were not among the higher heritabilities, and there were corresponding no left-right differences.



# Cortical folds predict V1 location

Hinds, et al. Poster #330 Tuesday PM

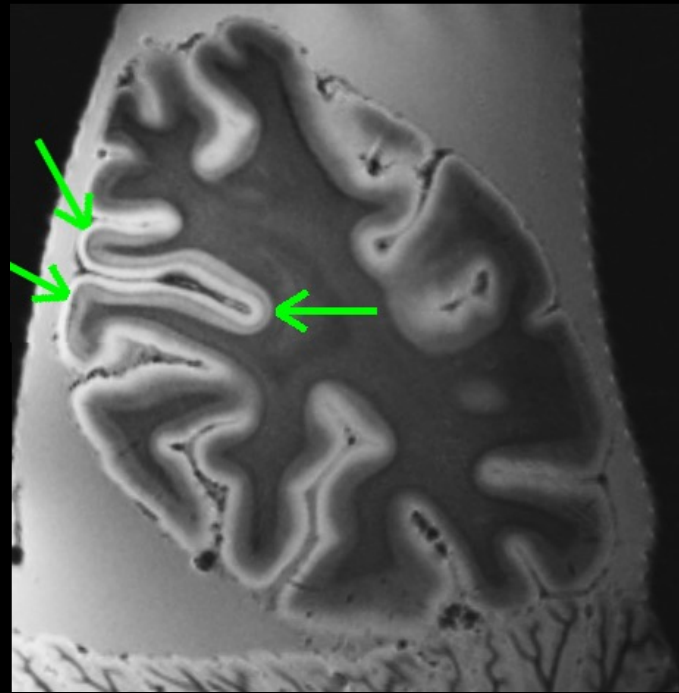

Left Hemisphere V1 Atlas

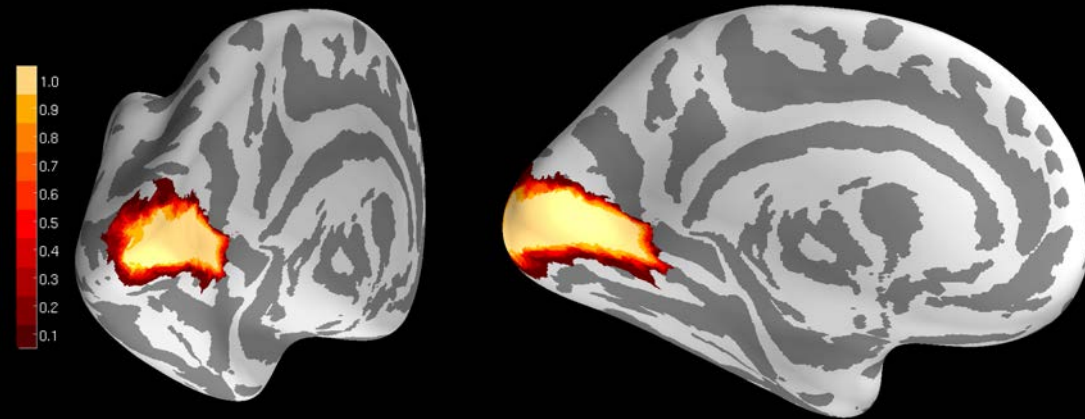

Right Hemisphere V1 Atlas

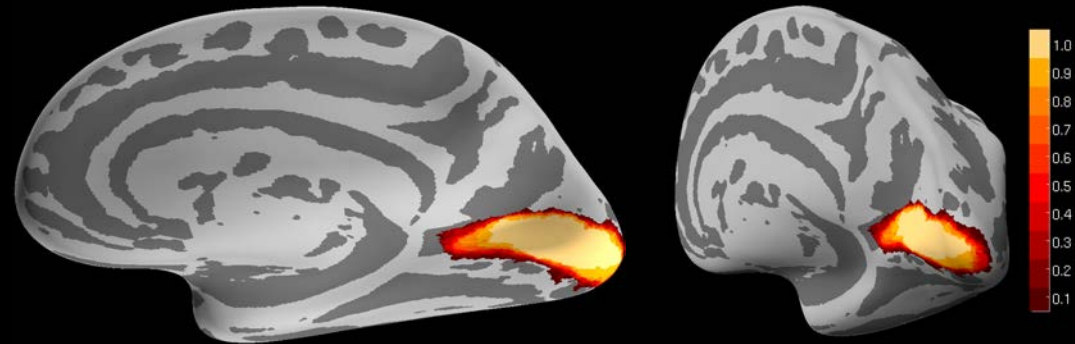

- Image *ex vivo* human at 7T
- Locate V1 via heavy myelin
- Build cortical surface mesh
- Register folds using FreeSurfer

- Build probabilistic atlas
- Excellent prediction accuracy

# The functional neuroanatomy of perisylvian language networks in schizophrenia: a DTI-tractography and fMRI study

## DTI-Tractography

## DCM Analysis

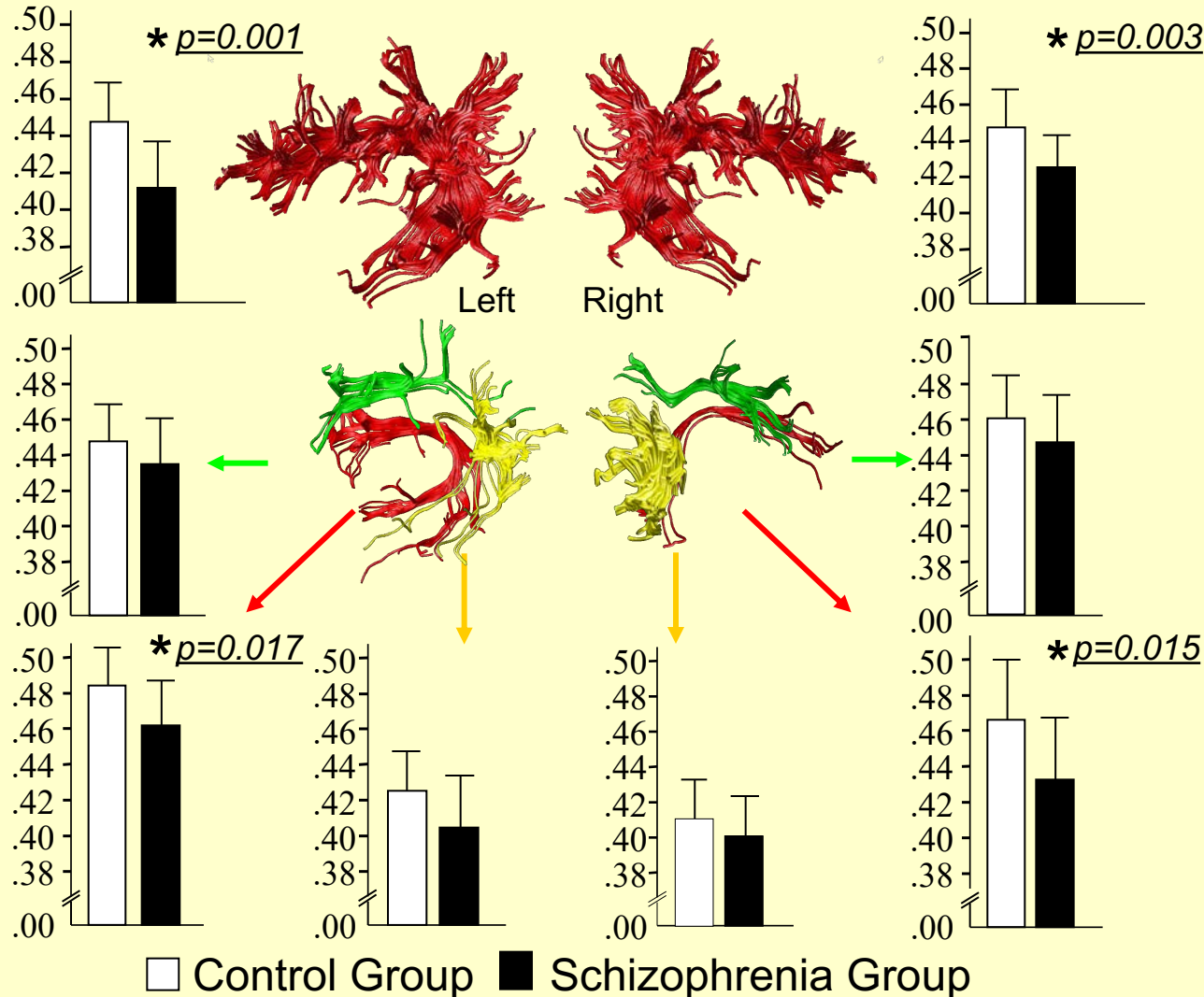

arcuate fasciculus

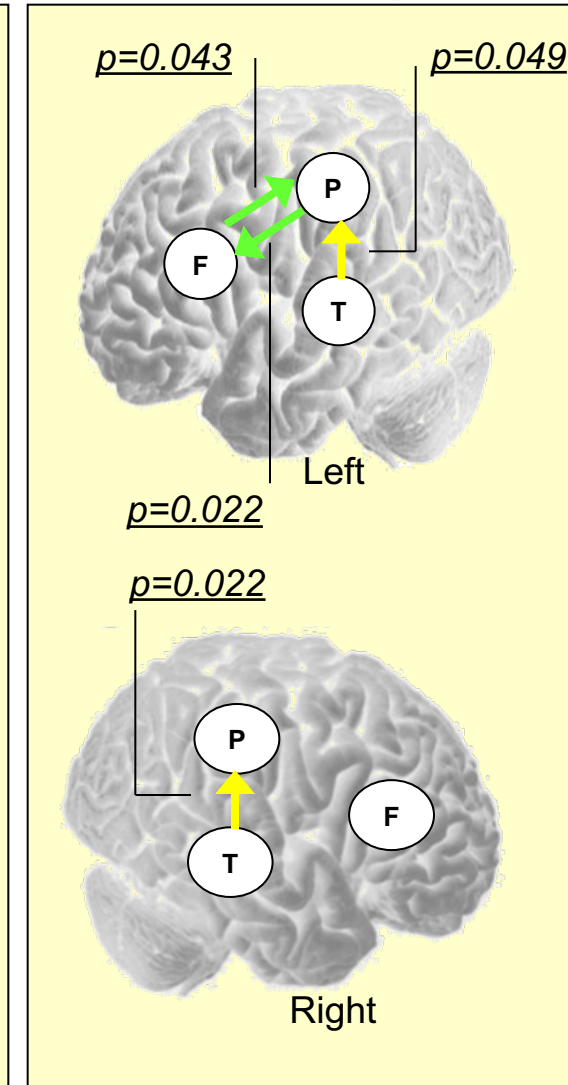

Pugliese et al. 252 Tuesday, PM

# Rostral anterior cingulate cortex (rACC) volume correlates with depressed mood in normal healthy boys

## Summary of Results:

- 1) Non-clinically depressed boys with mild depressive symptoms have lower rACC volume than boys with no reported symptoms ( $F = 12.8$ ,  $p = .001$ )
- 2) rACC volume negatively correlates with depressive symptoms in boys
- 3) Non-significant findings in girls

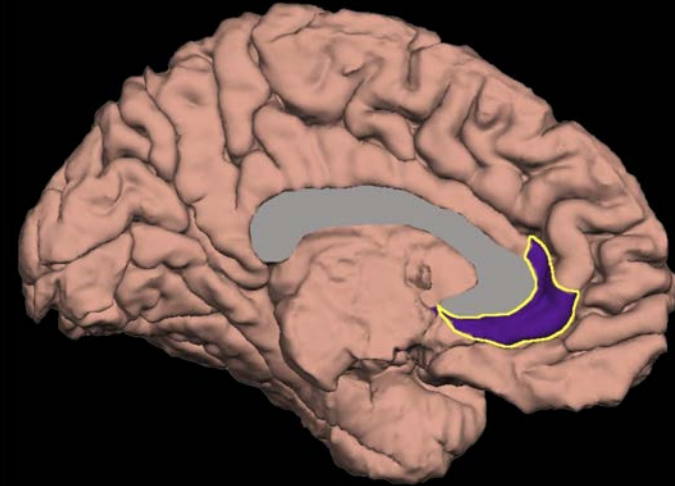

Implications: rACC structure may be a structural neural correlate of depression susceptibility

# Retinotopic Mapping of the Adult Human Visual Cortex with DOT

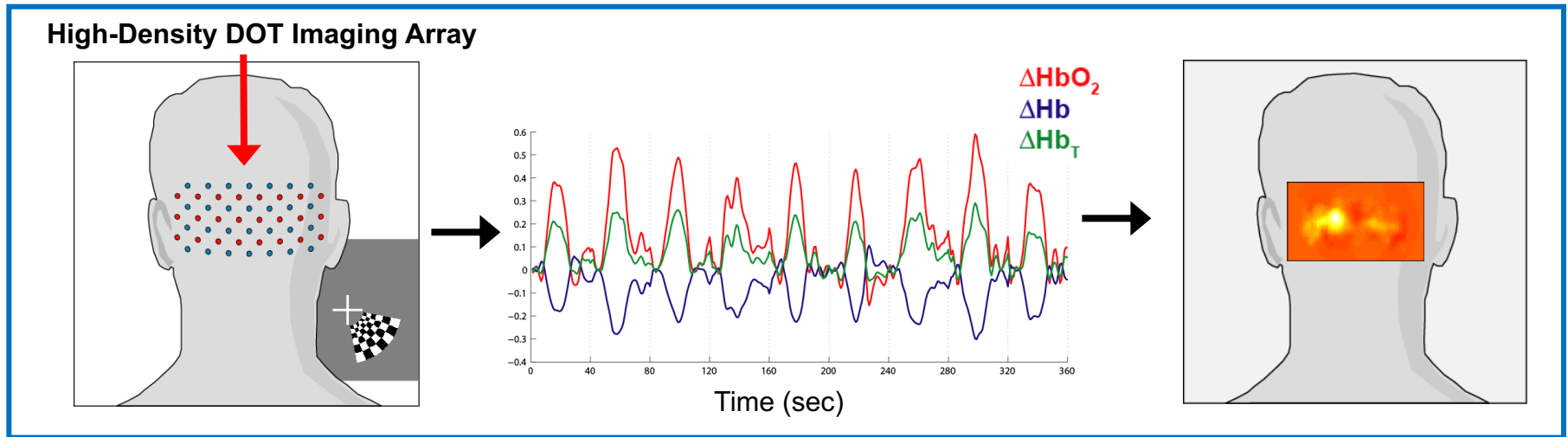

- Angle and Eccentricity Maps
- Robust and Repeatable
- Wearable Cap
- Target Populations:
  - ICU patients
  - Children

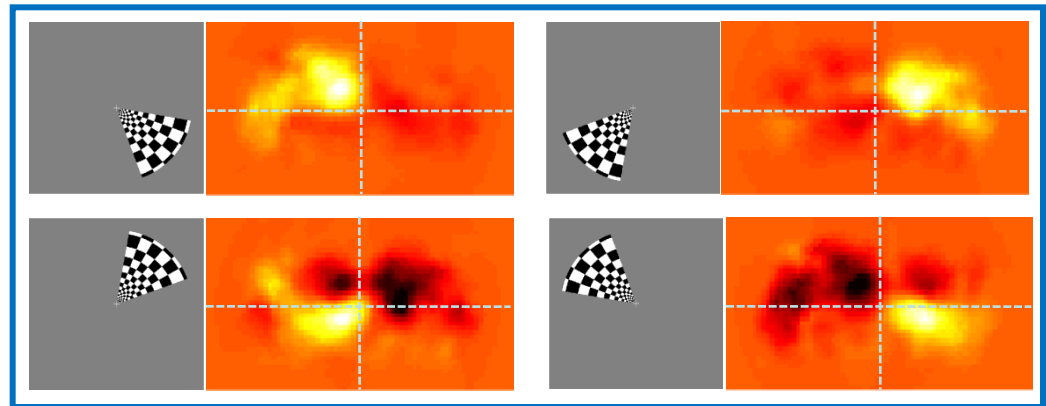

Brian R. White and Joseph P. Culver *et al.* 214 Monday PM



# Baseline brain activity fluctuations predict somatosensory perception

M. Boly, E. Balteau, C. Schnakers, C. Degueldre, G. Moonen, A. Luxen, C. Phillips, P. Peigneux, P. Maquet, S. Laureys  
Cyclotron Research Centre & Neurology Dept., University of Liège, Belgium

Poster #3 M-AM; Oral: "Cognition – Perception and Awareness" on Tuesday, June 12, 18:15.

## 3 seconds before stimulation:

- Baseline *fronto-parietal* activity is high  
⇒ stimulus will be *perceived*
- Baseline *default network* activity is high  
⇒ stimulus will be *missed*
- Baseline *pain matrix* activity is high  
⇒ stimulus will be *more painful*

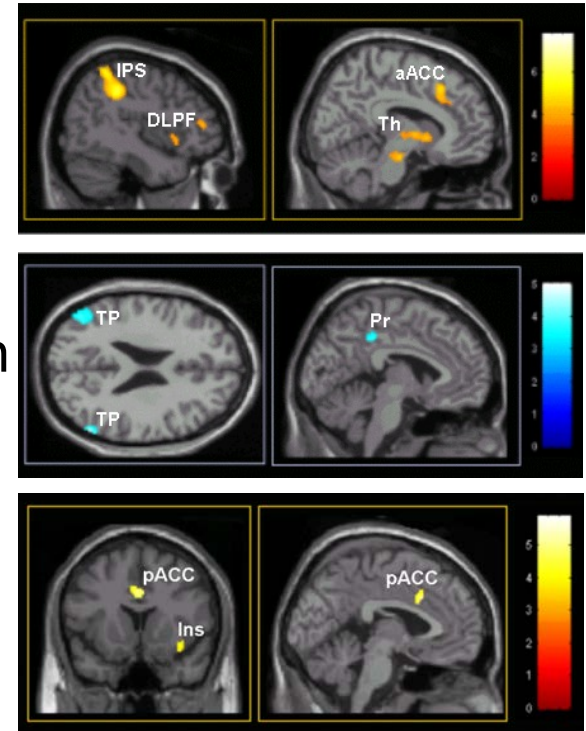

Spontaneous baseline activity fluctuations foretell sensory and pain intensity perception.



SUNDAY JUNE 10		MONDAY JUNE 11	TUESDAY JUNE 12	WEDNESDAY JUNE 13	THURSDAY JUNE 14			
<b>Educational Courses</b>								
Basic fMRI Course 8:00-17:30	Advanced fMRI Course 8:30-18:00	Advanced MEG/EEG Course 8:00-18:00	Cognitive Neuroscience Course 8:00-17:30	Structural Brain Mapping Course 8:00-17:30	MORNING WORKSHOPS 8:00-9:15	MORNING WORKSHOPS 8:00-9:15	MORNING WORKSHOPS 8:00-9:15	MORNING WORKSHOPS 8:00-9:15
					LOC SYMPOSIUM 9:30-10:45	ORAL SESSIONS Imaging Techniques; Genetics; Disorders of the Nervous System 9:30-10:45	ORAL SESSIONS Imaging Techniques; Emotion and Motivation; Disorders of the Nervous System 9:30-10:45	ORAL SESSIONS Imaging Techniques; Cognition; Neuroanatomy 9:30-10:45
					KEYNOTE - Larry Squire 11:00-11:30	KEYNOTE - Mitsuo Kawato 11:00-11:30	KEYNOTE - Gary Glover 11:00-11:30	KEYNOTE - Maurizio Corbetta 11:00-11:30
					POSTER SESSION 11:30-12:30	POSTER SESSION 11:30-12:30	POSTER SESSION 11:30-12:30	POSTER SESSION 11:30-12:30
					LUNCH 12:30-13:45	LUNCH 12:30-13:45	LUNCH 12:30-13:45	LUNCH 12:30-13:45
					POSTER SESSION 13:45-14:45	POSTER SESSION 13:45-14:45	POSTER SESSION 13:45-14:45	POSTER SESSION 13:45-14:45
					SYMPOSIUM: Mapping Genetic Influences on Human Brain Structure and Function 15:00-16:15	SYMPOSIUM: A Multi-Level Perspective on the Neural Correlates of Perceptual Decision Making 15:00-16:15	SYMPOSIUM: Repetition and the Brain: From Neurons to Computational Models Using Multimodal Approaches 15:00-16:15	ORAL SESSIONS Modeling and Analysis; Cognition; Sensory Systems 15:00-16:15
					KEYNOTE - Brian Wandell 16:30-17:00	TOWN HALL MEETING 16:30 -17:00	KEYNOTE - Willem Levelt 16:30-17:00	MEETING HIGHLIGHTS: Peter Bandettini, Past Chair 16:30 - 17:30
					ORAL SESSIONS Modeling and Analysis; Memory; Disorders of the Nervous System 17:00 -18:15	KEYNOTE - Leah Krubitzer 17:00-17:30	ORAL SESSIONS Modeling and Analysis; Emotion and Motivation; Language 17:00 -18:15	FAREWELL RECEPTION 17:30-18:30
					ORAL SESSIONS Modeling and Analysis; Cognition; 17:00 -18:15	ORAL SESSIONS Modeling and Analysis; Cognition; 17:00 -18:15	ORAL SESSIONS Modeling and Analysis; Emotion and Motivation; Language 17:00 -18:15	ORAL SESSIONS Modeling and Analysis; Emotion and Motivation; Language 17:00 -18:15
OPENING CEREMONIES 18:30	POSTER RECEPTION 18:30-19:30	Motor Behavior 17:30 -18:45	POSTER RECEPTION 18:30-19:30					
TALAIRACH LECTURE Daniel Kahneman	POSTER RECEPTION 19:00-20:00	POSTER RECEPTION 19:00-20:00	POSTER RECEPTION 18:30-19:30					
WELCOME RECEPTION 19:30			CLUB NIGHT 21:00					



# Vince Calhoun

Resting state ICA & classification for characterization of schizophrenia and bipolar patients

Results show a high average sensitivity (90%) and specificity (95%). Controls were correctly classified 95% of the time, schizophrenia patients 92%, and bipolar patients 81%.

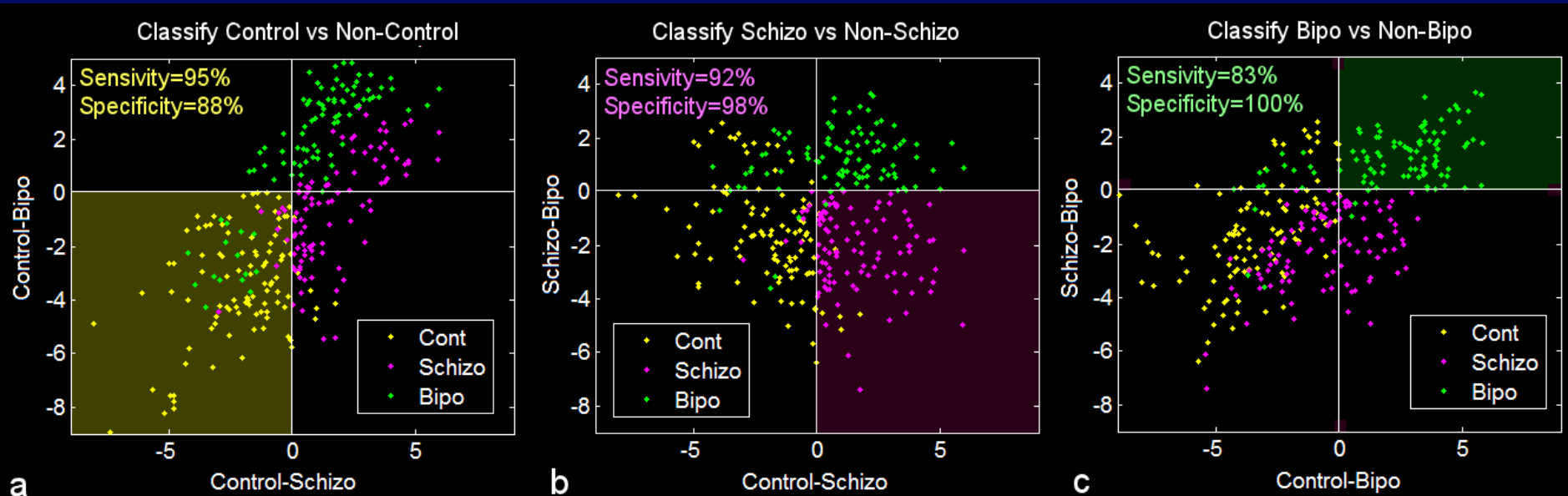
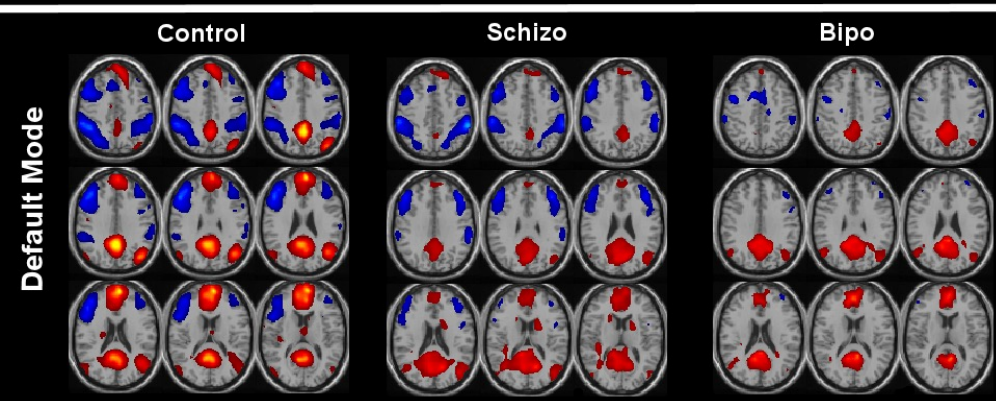
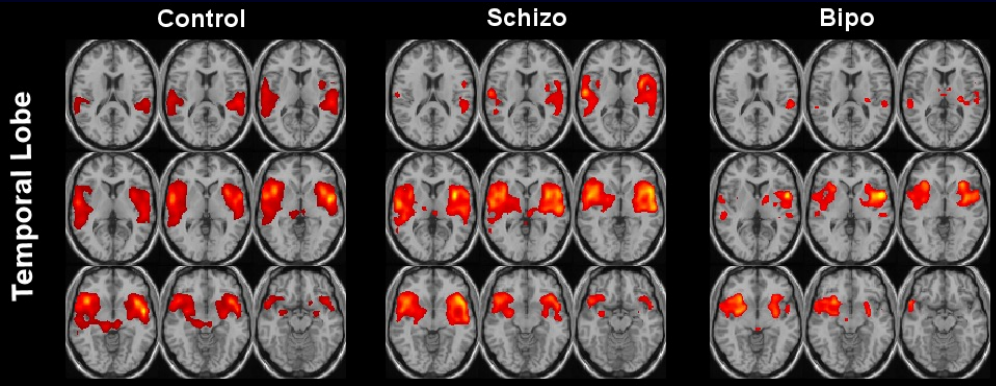

*Coupling between single-unit activities, gamma-LFP and BOLD-fMRI in human auditory cortex is tightly linked to the degree of inter-neuronal correlations*

*Yuval Nir, Lior Fisch, Roy Mukamel, Hagar Gelbard-Sagiv, Amos Arieli, Itzhak Fried and Rafael Malach*

- A wide range of coupling levels between spikes and gamma LFP power in the same experimental setup.
- Spike-gamma coupling is tightly related to inter-neuronal correlations during stimulation and rest.
- Gamma LFP had high sustained coupling to BOLD.
- Individual neurons had variable coupling to BOLD, and this was related to inter-neuronal correlations.

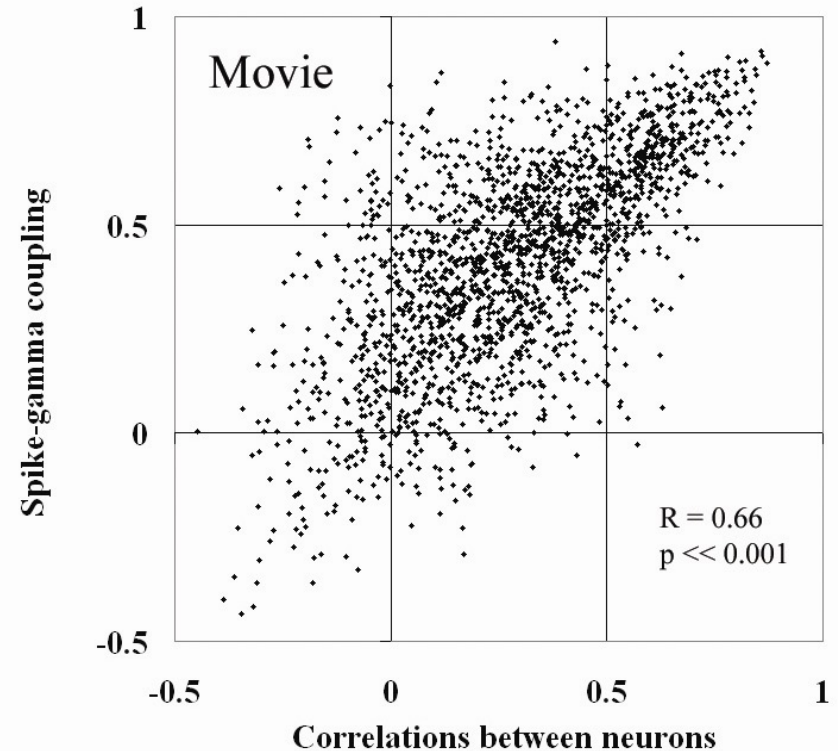

Presented in the "Imaging Techniques - MRI Methods 1" session on Wednesday morning

# Spontaneous fluctuations in fMRI signal correlate with fluctuations in the underlying local neuronal activity

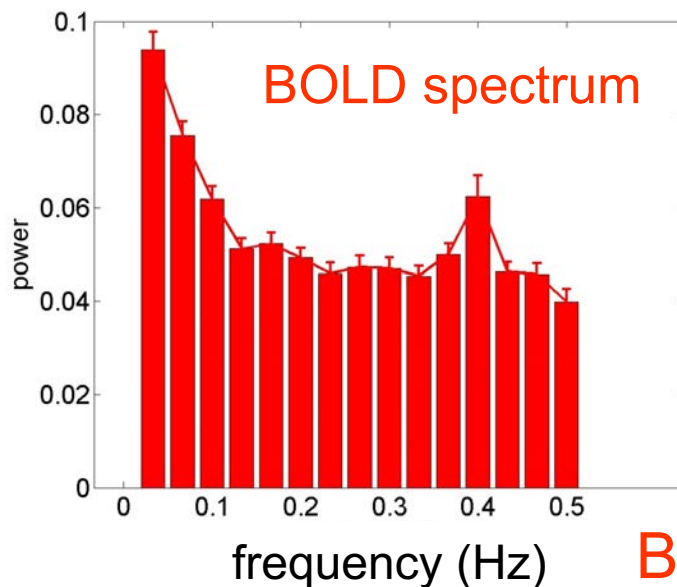
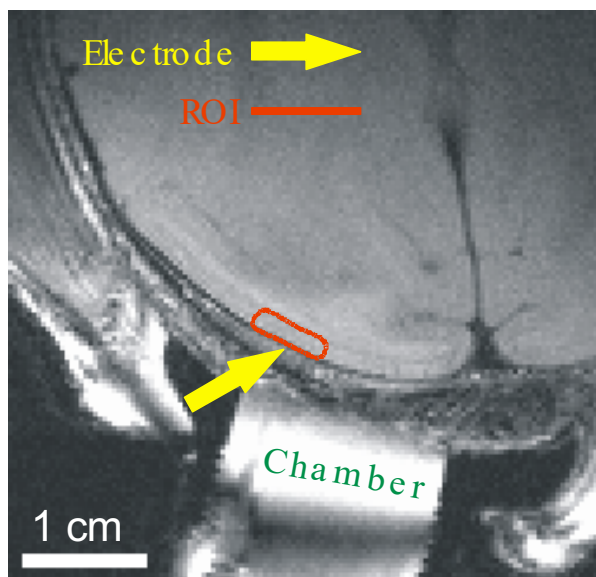

A Shmuel,  
M Augath,  
A Oeltermann,  
N Logothetis

Area 1

BOLD ↔ Neuro

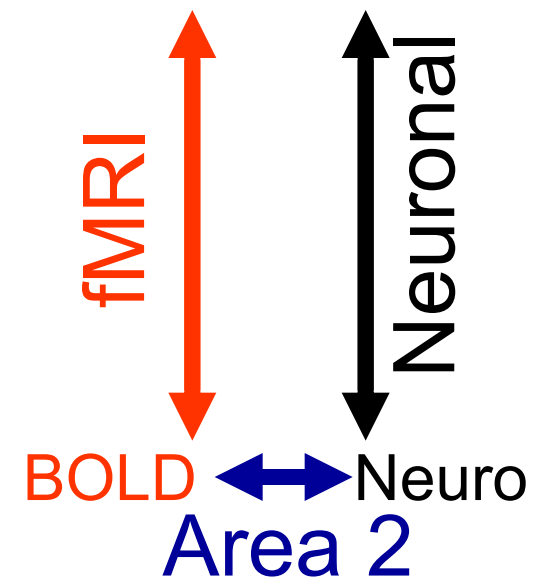
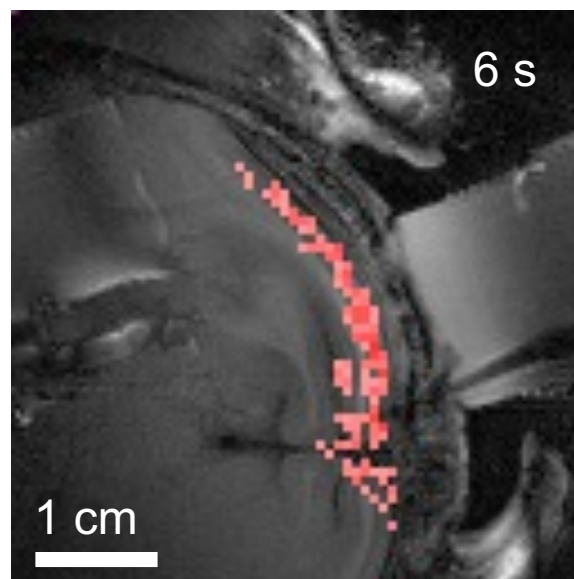
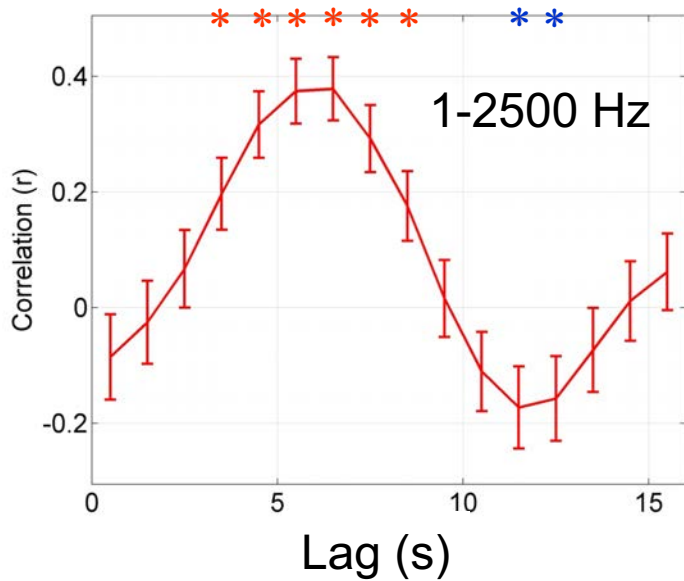



# Matching categorical object representations in IT cortex of man & monkey

Kriegeskorte N, Mur M, Ruff D, Kiani R, Bodurka J, Bandettini P

## dissimilarity matrices

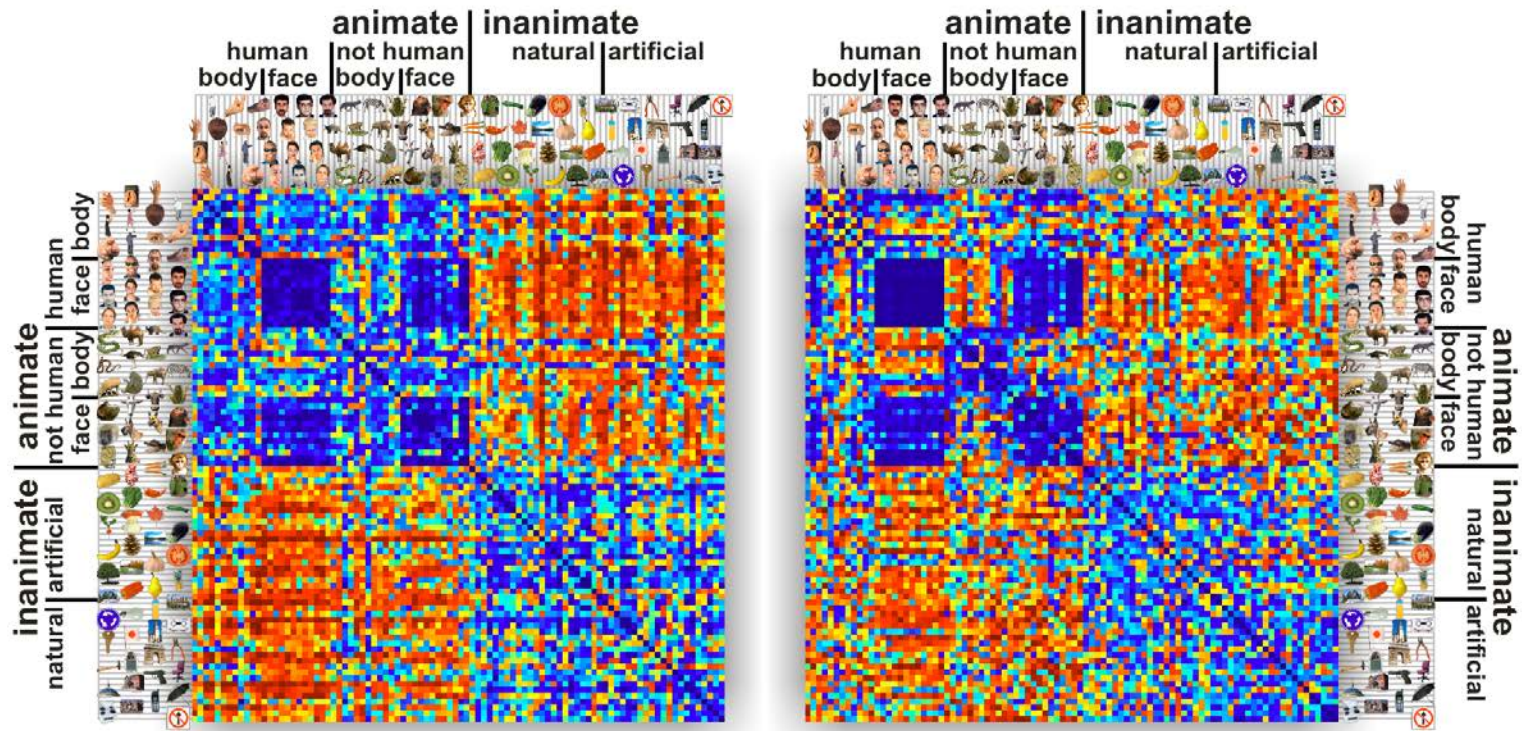

man

monkey

# Alternatives to T2\*-wtd BOLD contrast

- **Collecting BOLD contrast**
  - SE: T2 -weighting
  - RASER
  - SSFP
- **Other hemodynamic contrasts**
  - CBF
  - CBV
  - SEEP
  - T1
- **Non-hemodynamic contrasts**
  - Diffusion
  - Direct neural current

# Reconstruction of arbitrary visual images from fMRI signals by the combination of local image decoders

Yoichi Miyawaki<sup>1,2</sup>, Hajime Uchida<sup>3,2</sup>, Okito Yamashita<sup>2</sup>, Masa-aki Sato<sup>2</sup>,  
Hiroki C. Tanabe<sup>4</sup>, Norihiro Sadato<sup>4</sup>, and Yukiyasu Kamitani<sup>2,3</sup>

1) NICT, 2) ATR Comput Neurosci Lab, 3) NAIST, 4) NIPS; E-mail:yoichi\_m@atr.jp

## Methods:

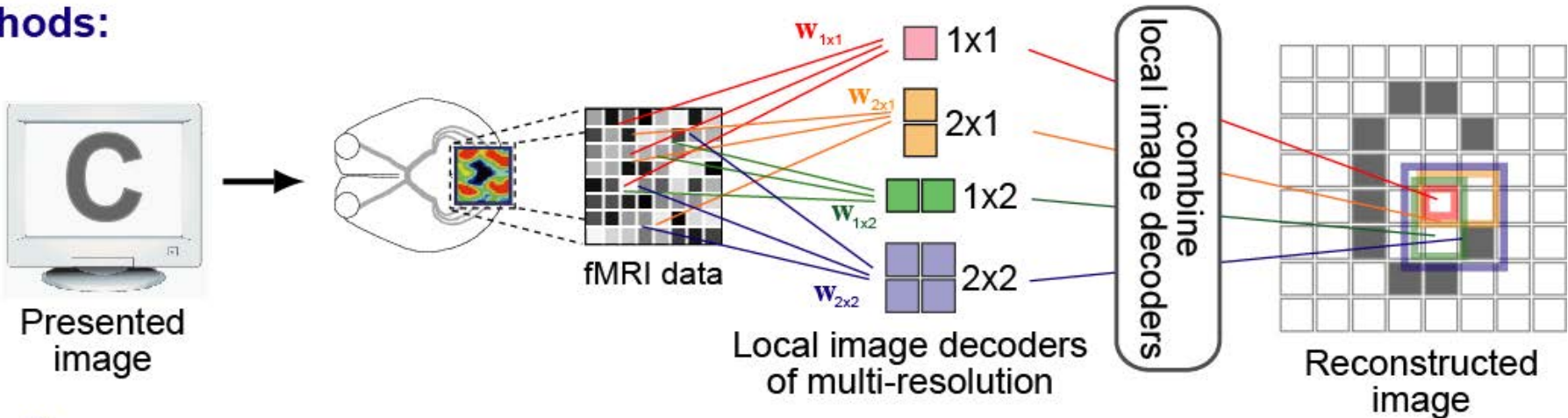

## Results:

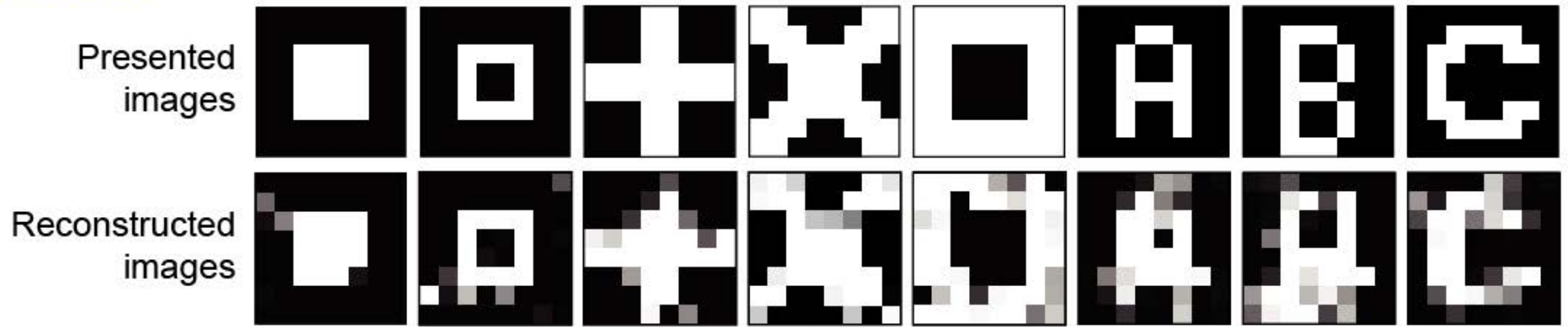



# Predicting perceived natural scene categories from distributed patterns of fMRI activity

Dirk B. Walther, Eamon Caddigan,  
Justas Birgiolas, Li Fei-Fei, Diane Beck

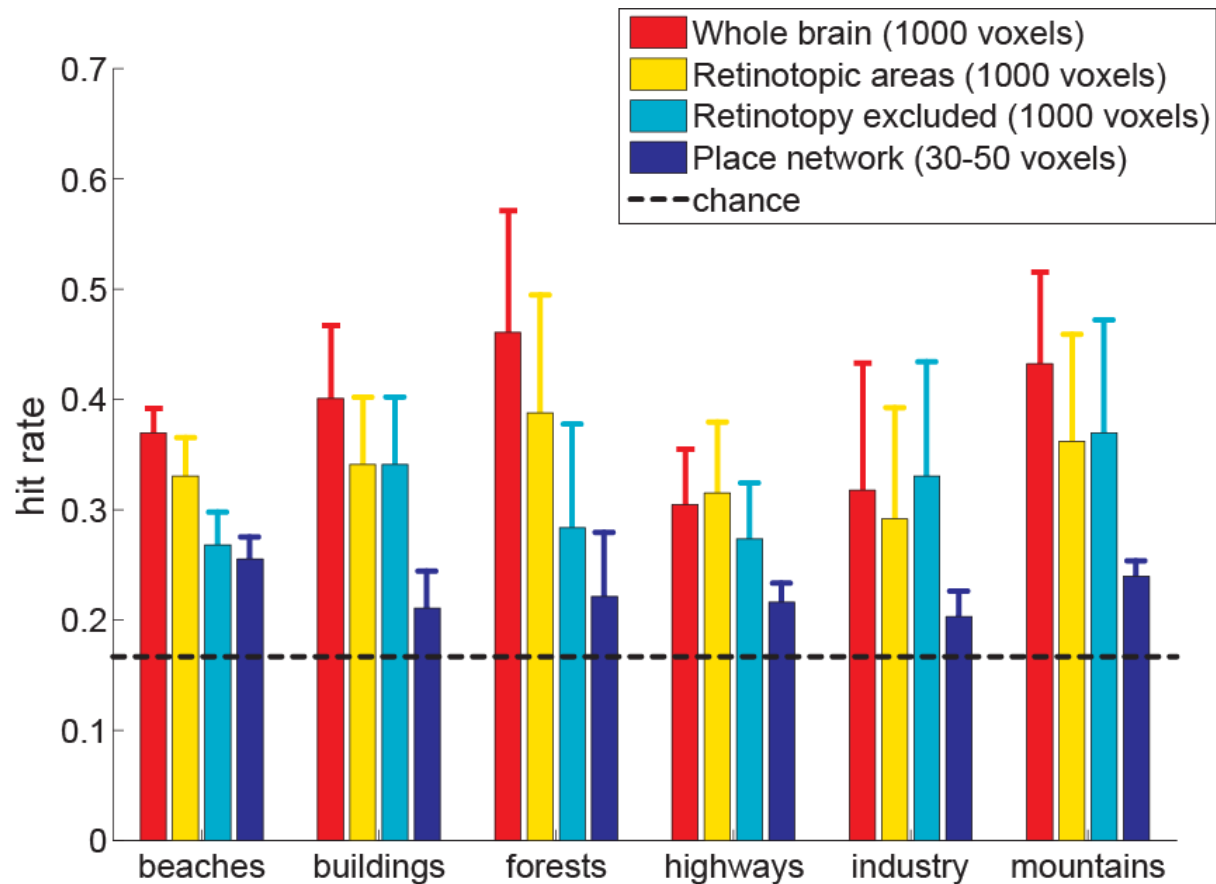
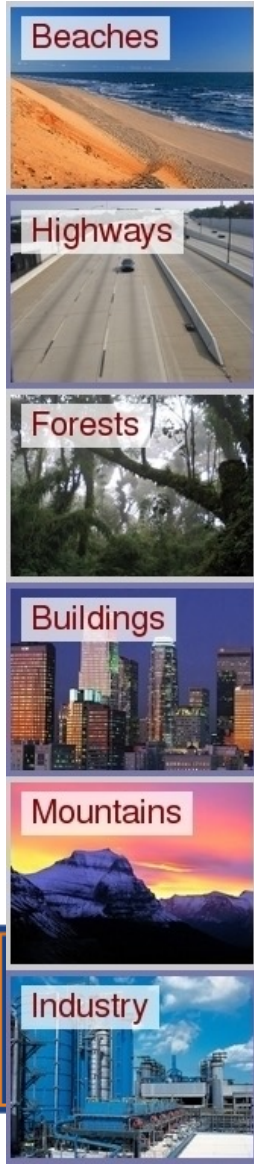

# Functional Connectivity Reflects Structural Connectivity in a Human Memory Network

Greicius, Supekar, Menon, Dougherty: Wednesday PM

Resting-state fMRI was combined with DTI tractography to distinguish monosynaptic from polysynaptic connections in the default-mode network.

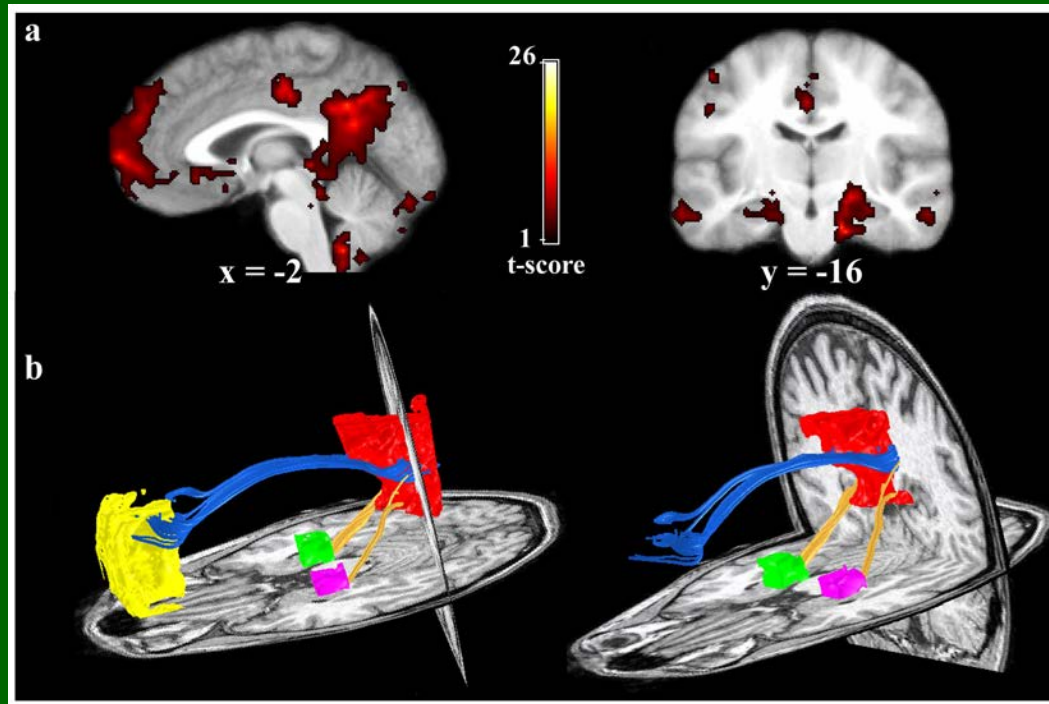
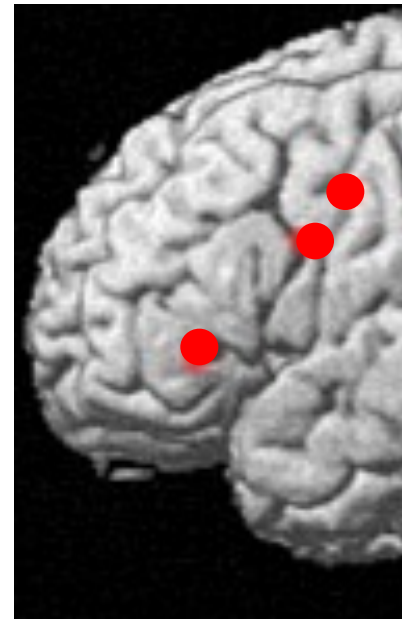
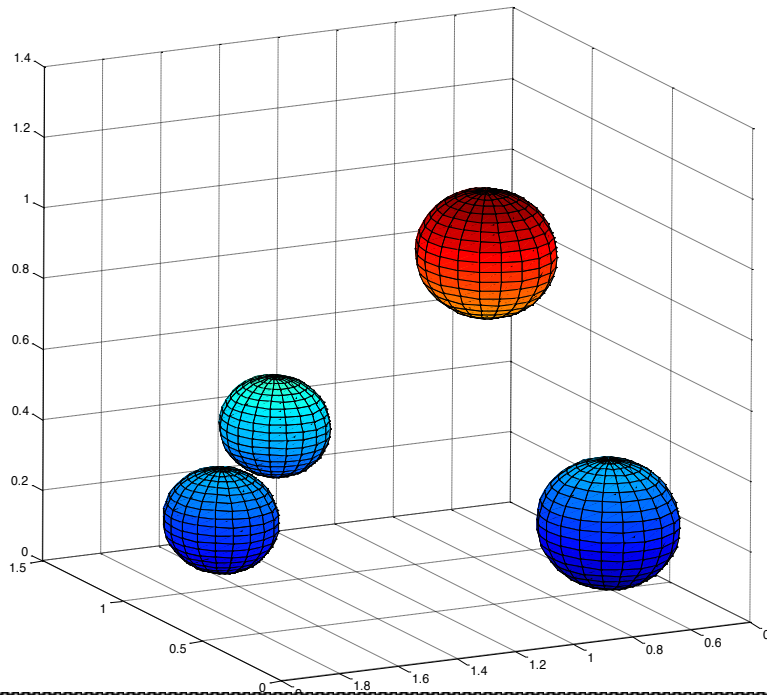

Figure 1: The default-mode network as detected by resting-state fMRI is shown in (a). DTI tractography (b) shows the cingulum bundle (blue) connecting the MPFC to PCC and fibers in the descending cingulum (gold) connecting PCC to MTL. **There were no tracts connecting MPFC to MTL suggesting that functional connectivity between these two nodes occurs via a third party, possibly the PCC.**

# Finding Hidden Groups of Subjects from Intersubject Variability

FERATH KHERIF: **POSTER 179 T-AM**  
LANGUAGE SESSION : **WEDNESDAY 5:30PM**



Results dissociate 4 subgroups of subjects who differentially activate semantic or non-semantic pathways for reading aloud simple words.

(Gaussian Mixture Model)



# PubBrain:

An interactive website for literature visualization and exploration

DJ Kalar, RA Poldrack, DS Parker, VI Torvik, NR Smalheiser, RM Bilder



## Welcome to PubBrain

Enter your (PubMed) search terms below. An activation map of cortical and sub-cortical structures will be generated based on the search terms. The map will show the co-occurrence of labeled anatomical regions with a set of

Working...

1000 / 27520

Search String:

Please note: Cookies must be enabled in order to use this website.

Supported by NIH Roadmap Initiative P20 RR020750 '[Center for Cognitive Phenomics](#)'  
[Email](#) comments or suggestions.

Request from 76.167.202.48

## “Stroop Task”

Thalamus: 14

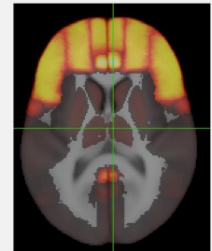
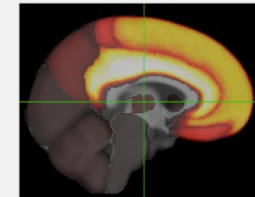
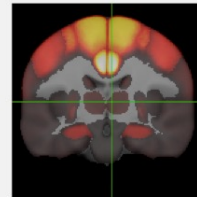

>0  222





# The Neuroimaging Informatics Tools and Resources Clearinghouse (NITRC)



**<sup>1</sup>Robert Buccigrossi, <sup>2</sup>Mark Ellisman, <sup>2</sup>Jeff Grethe, <sup>3</sup>Christian Haselgrove, <sup>4</sup>David Kennedy, <sup>2</sup>Maryann Martone, <sup>1</sup>Kim Pohland, <sup>1</sup>Nina Preuss, <sup>1</sup>Maureen Sullivan, <sup>1</sup>Judith Turner & <sup>1</sup>Keith Wagner**

**<sup>1</sup>Turner Consulting Group, Inc., Washington, DC; <sup>2</sup>University of California, San Diego, CA; <sup>3</sup>Neuromorphometrics, Inc, Somerville, MA; <sup>4</sup>David N. Kennedy Consulting, Belmont MA.**

**[nitrc.nih.gov](http://nitrc.nih.gov)**



SUNDAY JUNE 10		MONDAY JUNE 11	TUESDAY JUNE 12	WEDNESDAY JUNE 13	THURSDAY JUNE 14
<b>Educational Courses</b>					
		MORNING WORKSHOPS 8:00-9:15	MORNING WORKSHOPS 8:00-9:15	MORNING WORKSHOPS 8:00-9:15	MORNING WORKSHOPS 8:00-9:15
		LOC SYMPOSIUM 9:30-10:45	ORAL SESSIONS Imaging Techniques; Genetics; Disorders of the Nervous System 9:30-10:45	ORAL SESSIONS Imaging Techniques; Emotion and Motivation; Disorders of the Nervous System 9:30-10:45	ORAL SESSIONS Imaging Techniques; Cognition; Neuroanatomy 9:30-10:45
		KEYNOTE - Larry Squire 11:00-11:30	KEYNOTE - Mitsuo Kawato 11:00-11:30	KEYNOTE - Gary Glover 11:00-11:30	KEYNOTE - Maurizio Corbetta 11:00-11:30
		POSTER SESSION 11:30-12:30	POSTER SESSION 11:30-12:30	POSTER SESSION 11:30-12:30	POSTER SESSION 11:30-12:30
		LUNCH 12:30-13:45	LUNCH 12:30-13:45	LUNCH 12:30-13:45	LUNCH 12:30-13:45
		POSTER SESSION 13:45-14:45	POSTER SESSION 13:45-14:45	POSTER SESSION 13:45-14:45	POSTER SESSION 13:45-14:45
		SYMPOSIUM: Mapping Genetic Influences on Human Brain Structure and Function 15:00-16:15	SYMPOSIUM: A Multi-Level Perspective on the Neural Correlates of Perceptual Decision Making 15:00-16:15	SYMPOSIUM: Repetition and the Brain: From Neurons to Computational Models Using Multimodal Approaches 15:00-16:15	ORAL SESSIONS Modeling and Analysis; Cognition; Sensory Systems 15:00-16:15
		KEYNOTE - Brian Wandell 16:30-17:00	TOWN HALL MEETING 16:30 -17:00	KEYNOTE - Willem Levelt 16:30-17:00	MEETING HIGHLIGHTS: Peter Bandettini, Past Chair 16:30 - 17:30
		ORAL SESSIONS Modeling and Analysis; Memory; Disorders of the Nervous System 17:00 -18:15	KEYNOTE - Leah Krubitzer 17:00-17:30	ORAL SESSIONS Modeling and Analysis; Emotion and Motivation; Language 17:00 -18:15	FAREWELL RECEPTION 17:30-18:30
			ORAL SESSIONS Modeling and Analysis; Cognition; 17:00 -18:15		
		POSTER RECEPTION 18:30-19:30	Motor Behavior 17:30 -18:45	POSTER RECEPTION 18:30-19:30	
			POSTER RECEPTION 19:00-20:00		
				CLUB NIGHT 21:00	
Basic fMRI Course 8:00-17:30					
Advanced fMRI Course 8:30-18:00					
Advanced MEG/EEG Course 8:00-18:00					
Cognitive Neuroscience Course 8:00-17:30					
Structural Brain Mapping Course 8:00-17:30					
OPENING CEREMONIES 18:30					
TALAIRACH LECTURE Daniel Kahneman					
WELCOME RECEPTION 19:30					

# Connectivity Based Parcellation of the Superior Temporal Cortex

Benjamin C. Stengel, Colin Humphries, Michael Austin, Jeffrey R. Binder

*Medical College of Wisconsin, Milwaukee, WI, USA*

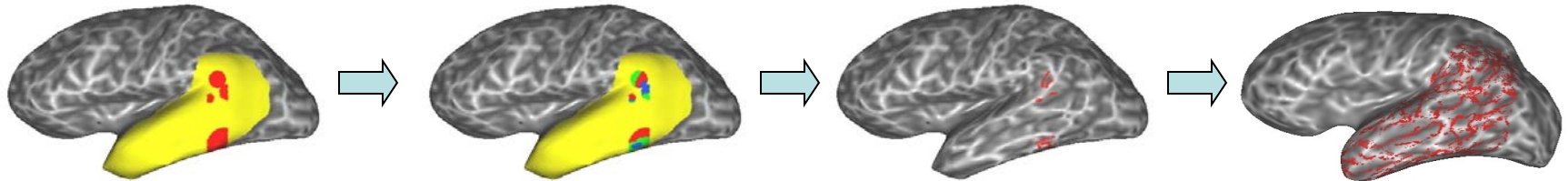

A novel, fully automated method for cortical parcellation:

- Thousands of random samples of small cortical regions.
- Clustering of tractography maps within each sample.
- Gradual accumulation of boundary points, resulting in a probabilistic boundary map.

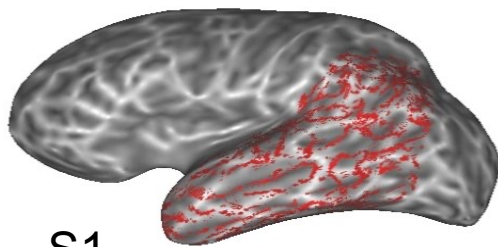

S1

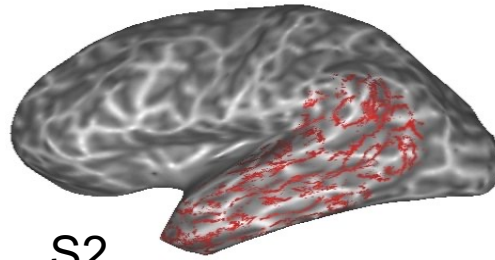

S2

Example of probabilistic boundary maps in two subjects

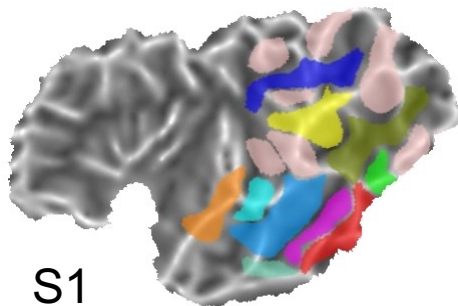

S1

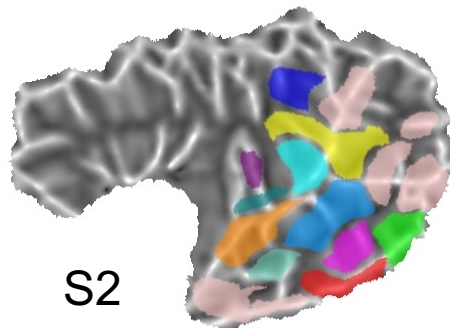

S2

Twelve areas identified based on common locations and connectivity patterns across subjects

# A Causal Role for the Right Fronto-Insular Cortex (FIC) in switching between Executive Control (ECN) and Default Mode Networks (DMN)

*Sridharan Devarajan, Daniel Levitin, Vinod Menon (Thu, 10AM)*

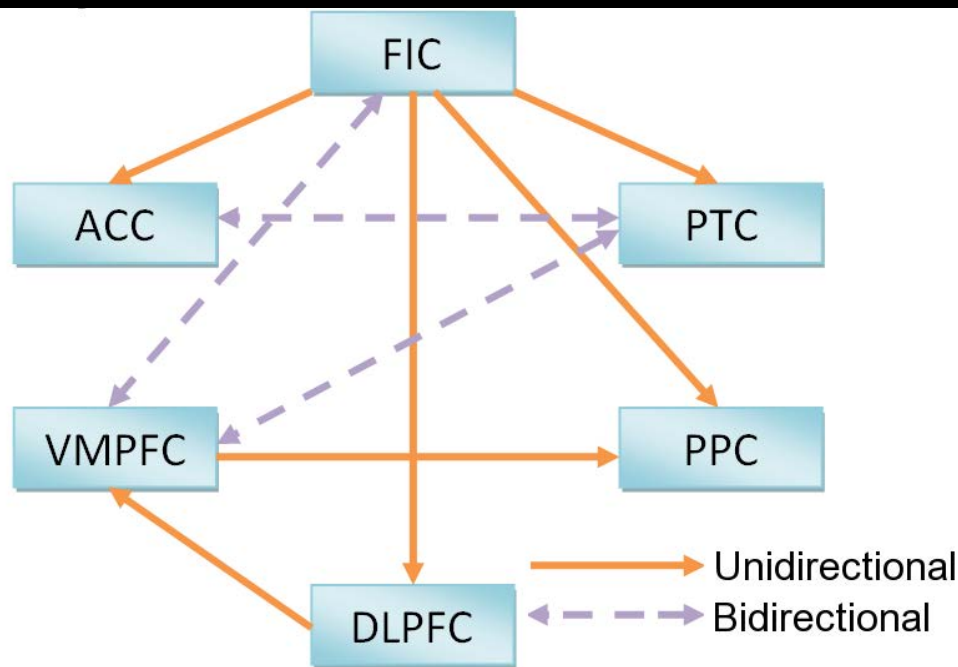

- Granger Causal Analysis revealed that the right FIC is a causal hub at the intersection of the ECN and DMN

- Right FIC is uniquely positioned to play a *critical causal role in switching* between the ECN and DMN

- These findings may have important implications for understanding the neural basis of cognitive control

ROI	Out-degree	In-degree	Path Length
<b>FIC</b>	<b>5</b>	<b>1</b>	<b>1.0</b>
ACC	1	2	1.6
VMPFC	3	3	1.2
DLPFC	1	1	1.6
PPC	0	2	1.6
PTC	2	3	1.4

# Reading hidden intentions in the human brain

Thu 9.45: Cognition – Representation and Processes

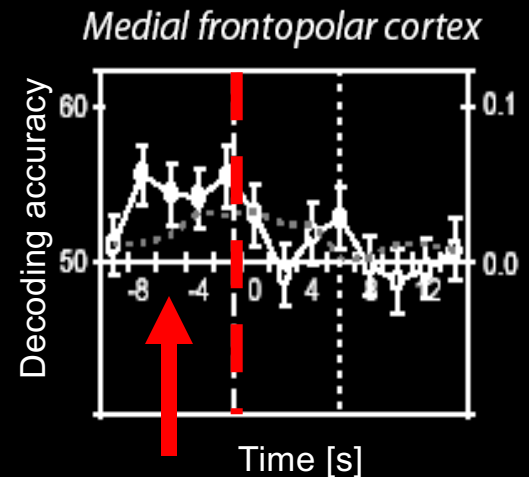
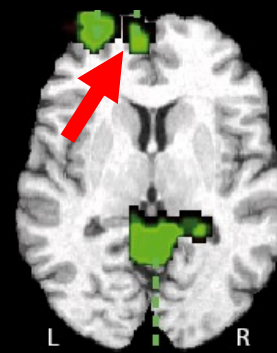
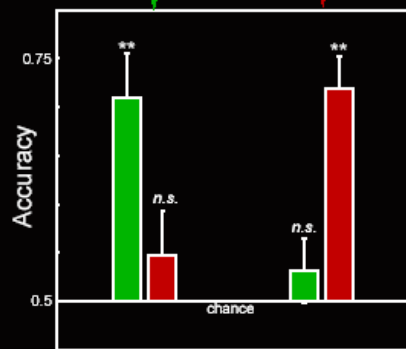
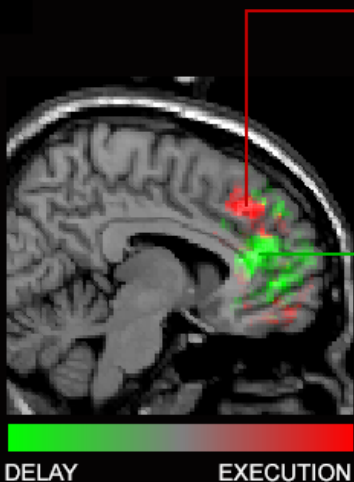
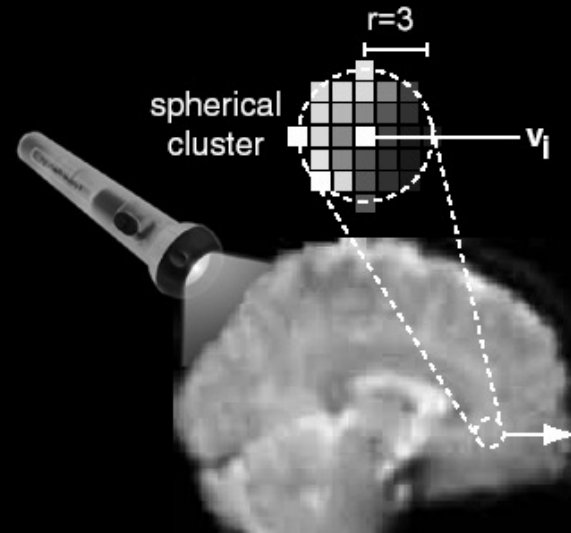
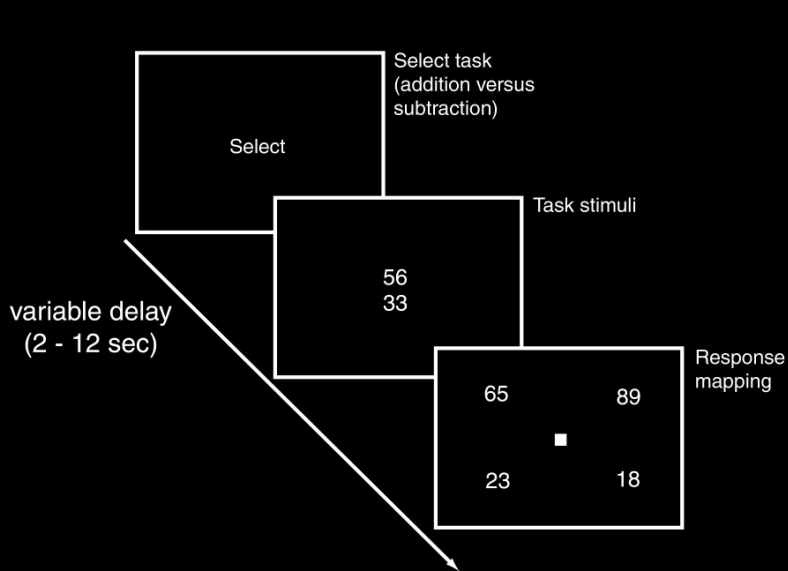

Haynes, Sakai, Rees, Gilbert, Frith & Passingham (Current Biology, 2007)

Soon, Brass, Heinze & Haynes (in preparation)

# The Neural Correlates of Mapping Numerical Quantities onto Abstract Symbols

Ian M. Lyons and Daniel Ansari

[Thursday Morning Presentation]

## I The Symbol-Mapping Problem

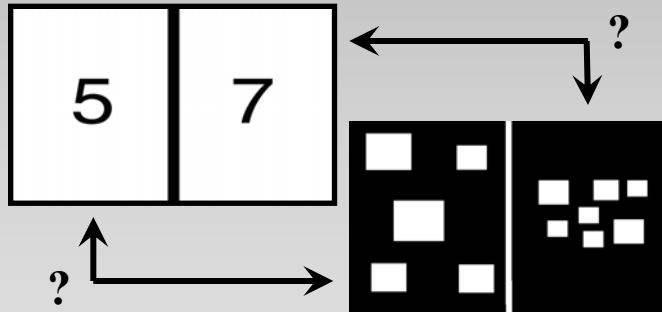

## II We simulated this symbol-mapping process using a novel set of symbols.

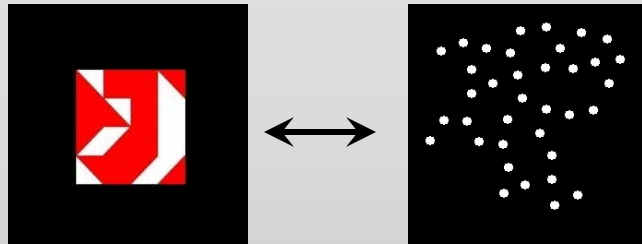

## III Participants then compared the symbols in terms of the approximate quantities they represented.

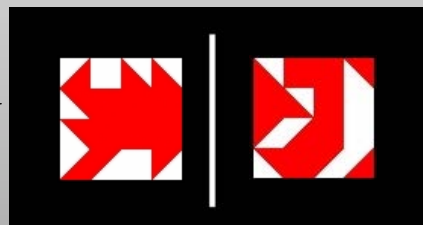

"Which represents more dots?"

## Numerical Comparison > Control

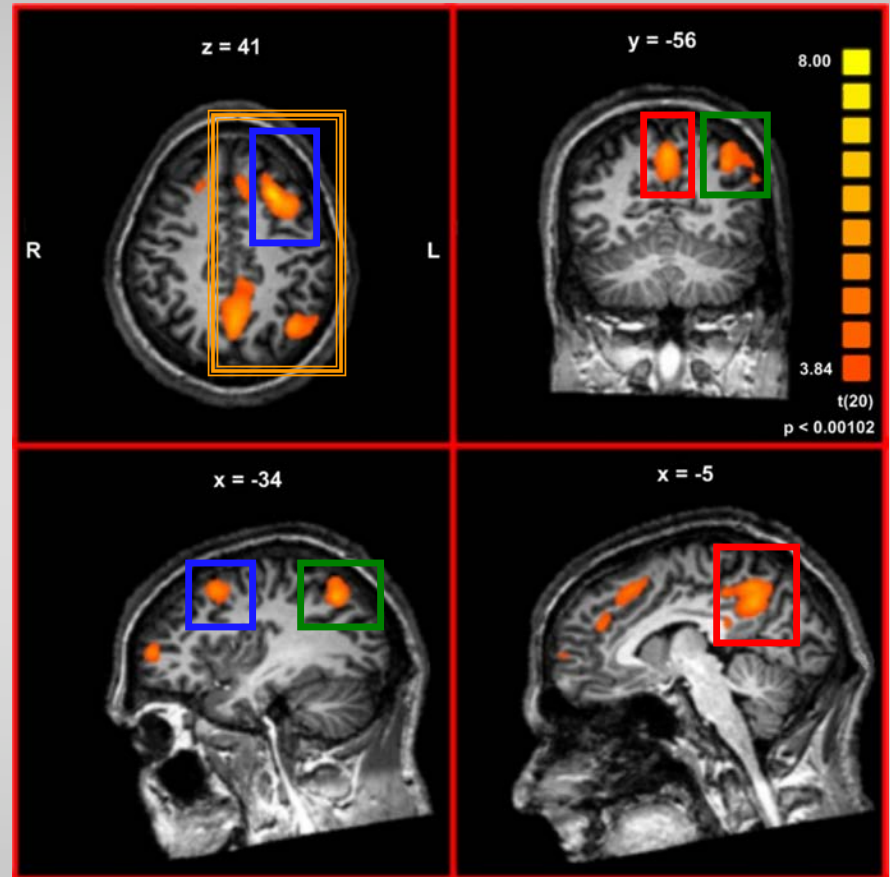

### ▶ Left-lateralized fronto-parietal network

▶ Precuneus: *Increased* activity with more training

\*Correlated with accuracy increases

▶ Left inferior parietal lobe: *Decreased* activity with training

▶ Left middle-frontal gyrus: *Decreased* activity with training

\*Rate of decrease highly correlated with parietal decrease

IV

V

# Does diffusion FMRI detect activation-induced neuronal swelling or vascular changes?

1. Signal increases with b-value during hypercapnia (purely vascular) and visual stimulation (activation)

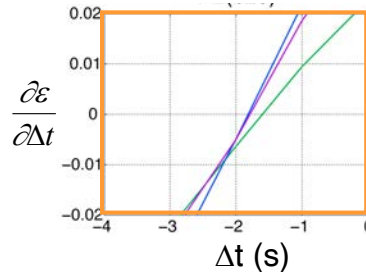
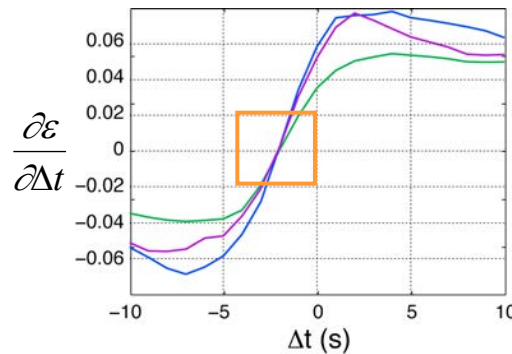
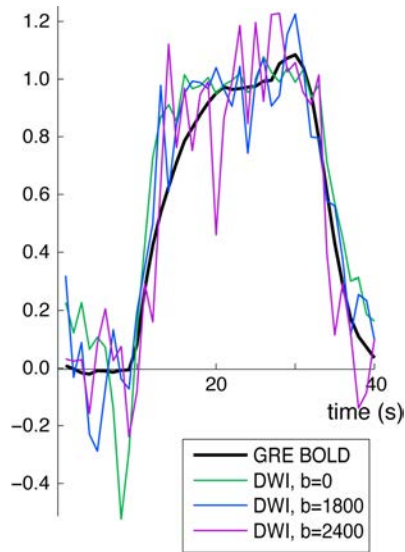
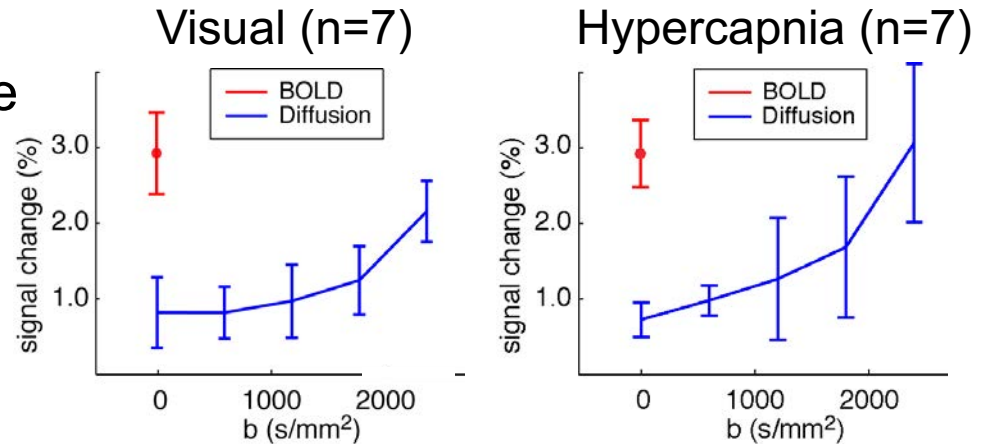

2. No fast response at high b-value

Strong evidence for a vascular component in diffusion FMRI

$$\varepsilon(\Delta t) = \sqrt{[\text{BOLD}(t) - \text{DWI}(t - \Delta t)]^2}$$



# The effects of musical training on structural brain development: a longitudinal study

Hyde, Lerch, Norton, Kotynek-Friedl, Lyengar, Forgeard, Evans, Winner & Schlaug

HBM poster #170, June 14, 2007, PM session



- Deformation based morphometry (DBM) was used to study structural brain plasticity in children who received instrumental musical training for ~15 months vs. control children who did not.

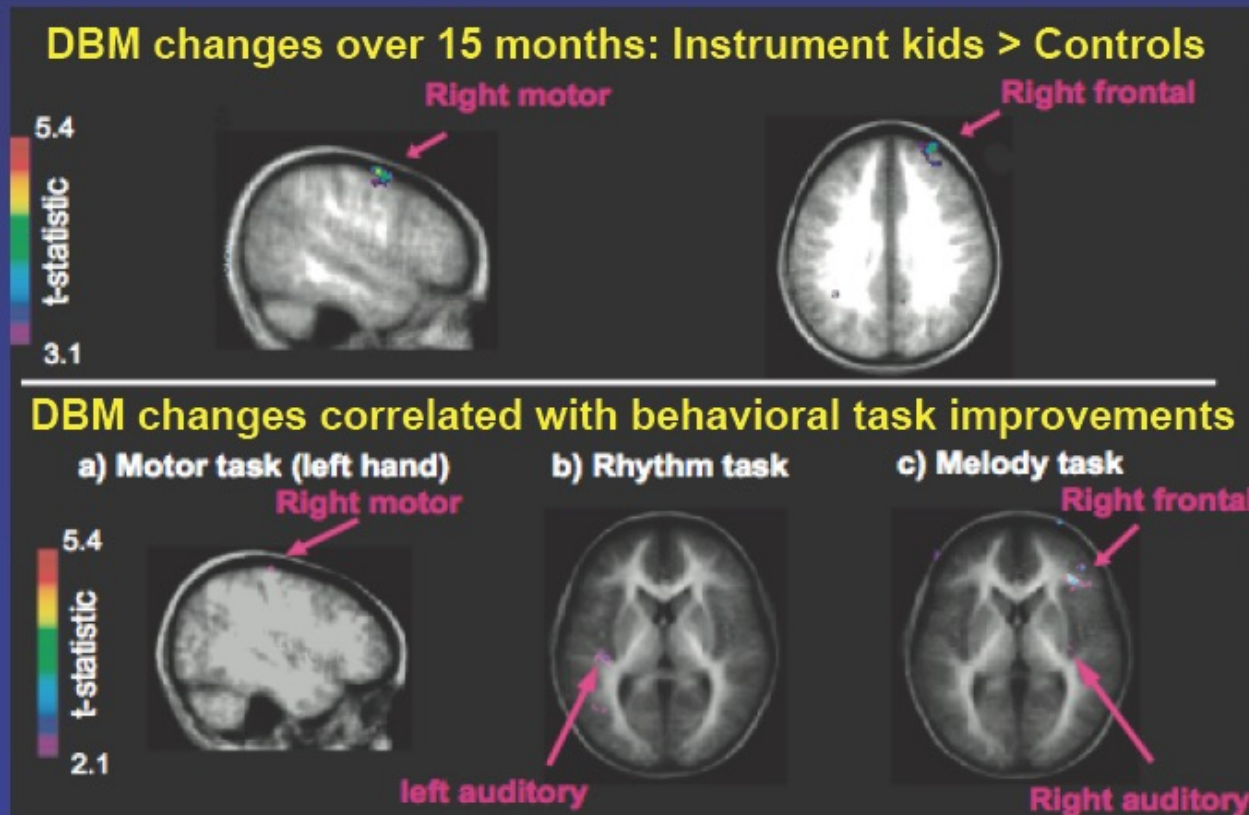

- We conclude that the differential development of these brain regions is induced by long-term instrumental practice.

# Baseline blood oxygenation modulates fMRI signals

## BOLD fMRI

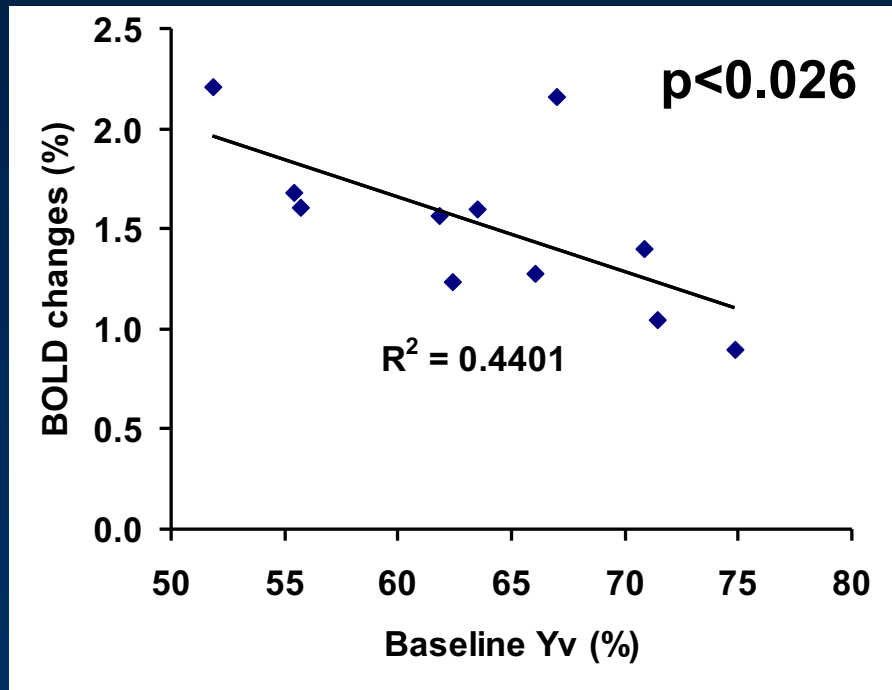

## ASL fMRI

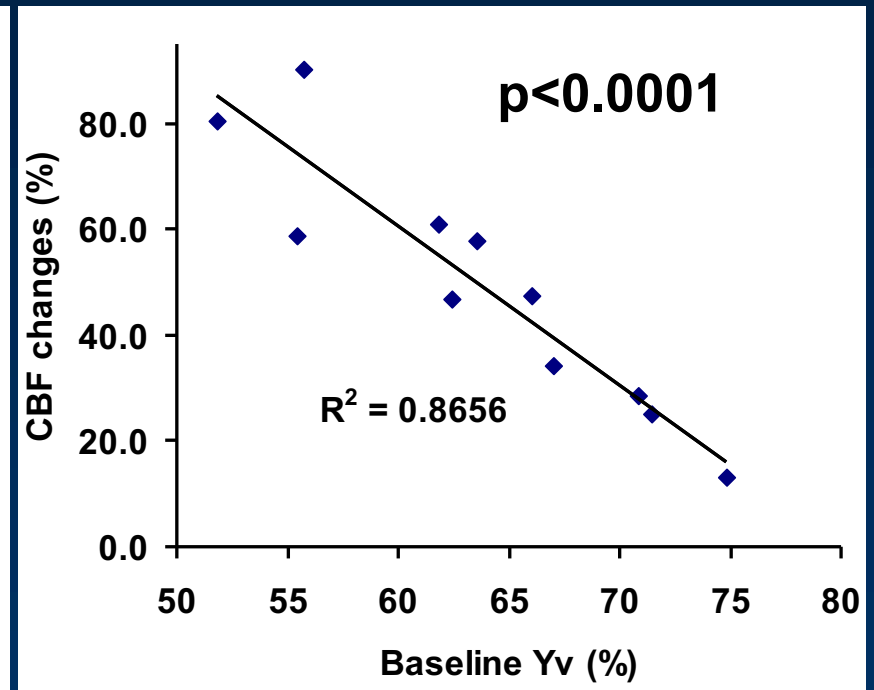

Individuals with **higher baseline venous oxygenation** tend to have **smaller BOLD and CBF** percentage signal changes

# Functional connectivity during deep sleep: a simultaneous EEG-fMRI study

Horovitz, Fukunaga, Carr, Picchioni, de Zwart, van Gelderen, Balkin, Braun, Duyn  
(poster 19 M-PM; talk Thurs 3pm)

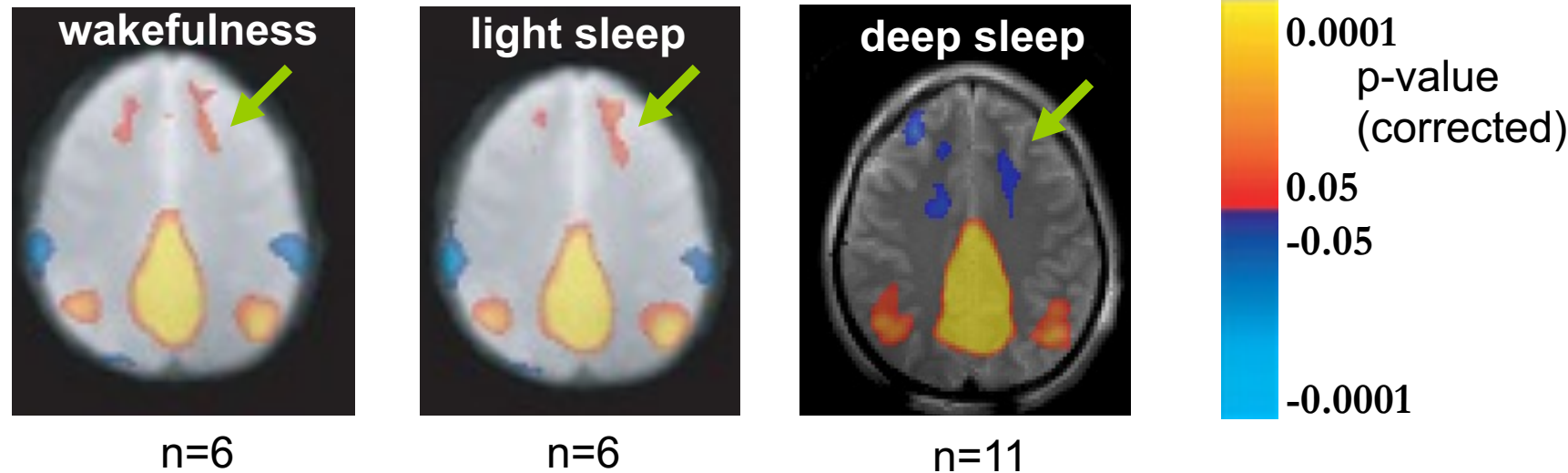

- Correlated activity is seen both during light and deep sleep.

- Anterior dissociations are observed during deep sleep

- Correlated fluctuations do not require a conscious level typical of the waking state.

Wakefulness and light sleep data  
from Horovitz et al, HBM 2007

# Using Movies to Identify Temporal Scales of Cortical Processing

*Hasson et al, Talk: Thursday 15.30, Poster #151 W-AM*

We demonstrate, similar to the known cortical hierarchy of spatial receptive fields, that there is a hierarchy of progressively longer temporal receptive windows in the human brain.

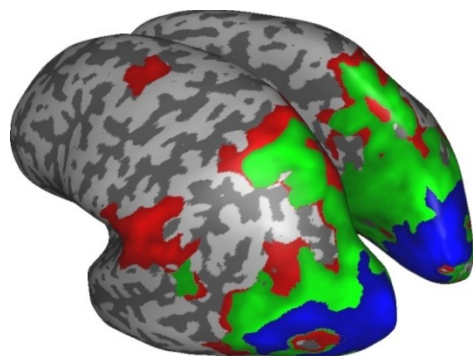

Short



V1, MT



Intermediate

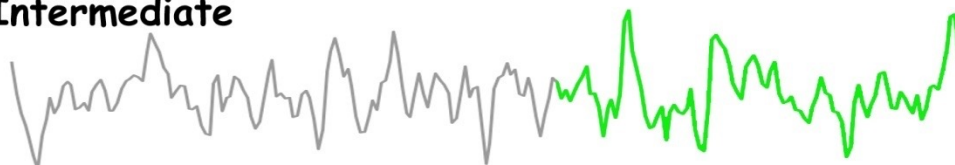

FFA, STS,  
Precuneus



Long



LS-TPJ, FEF



Time



# #188: Receptive fields of neuronal populations of the auditory cortex

Marc Schönwiesner & Robert Zatorre

TH-PM

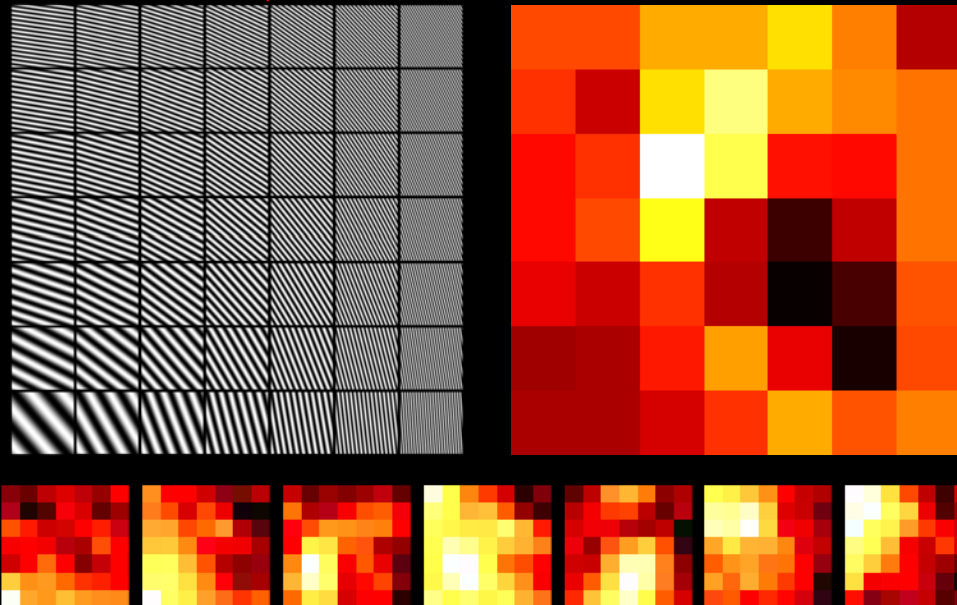
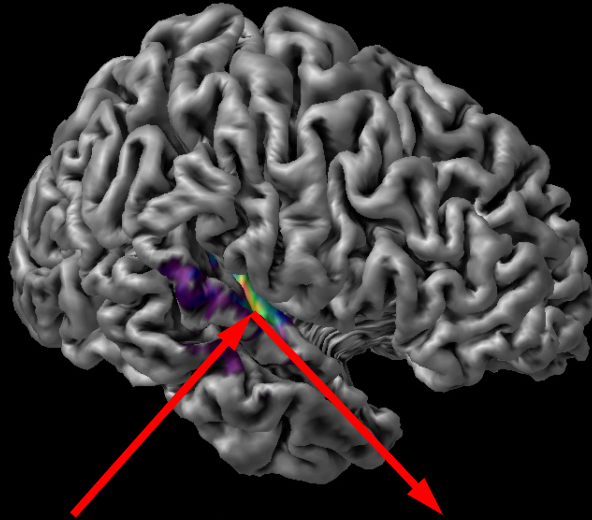

Spectro-Temporal Modulation transfer functions of single voxels in the human auditory cortex were measured with high-resolution fMRI and dynamic ripple stimuli, adapting methods from animal neurophysiology.



# #132 Social vs. Monetary Reward Processing in Typically Developing Children

Th-PM

A. Scott, S. Cox, D. Ghahremani, J. Cohen, R. Poldrack, M. Dapretto and S. Bookheimer  
 UCLA Center for Cognitive Neuroscience

## Rewards

### Monetary



### Neutral

Correct ✓

### Social



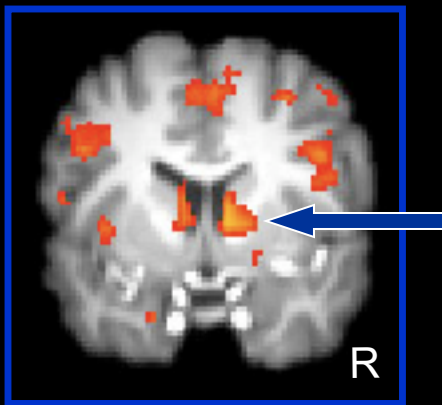

That's Right!

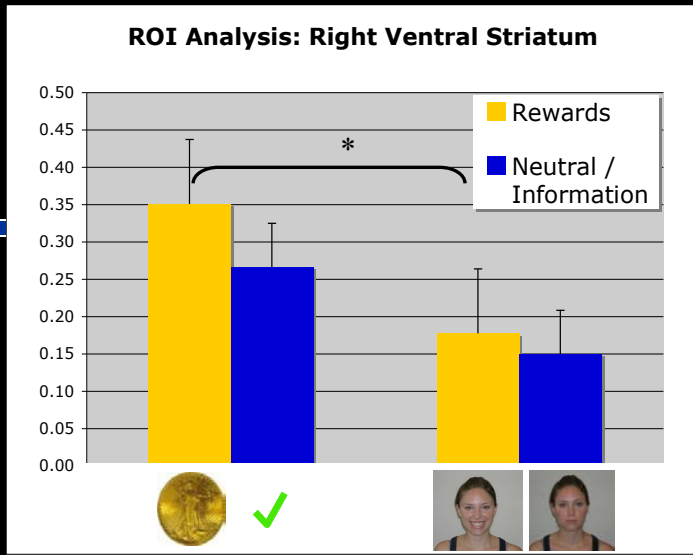

Reward-related Activity



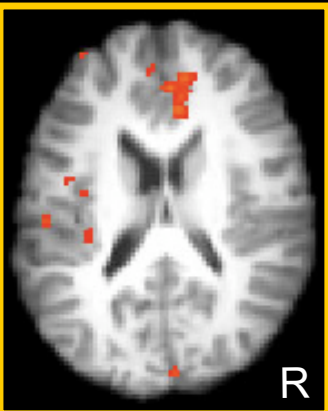

>

- Cingulate
- Ventrolateral PFC



z = +18

>

- Amygdala
- Medial PFC
- Orbital PFC

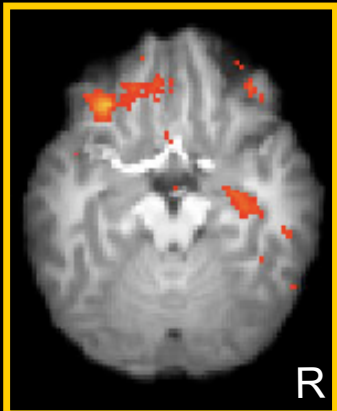

z = -20

# YOQ

THURSDAY  
SEPTEMBER 23, 2004

# SPM MADE EASY

## Tried and tested tips

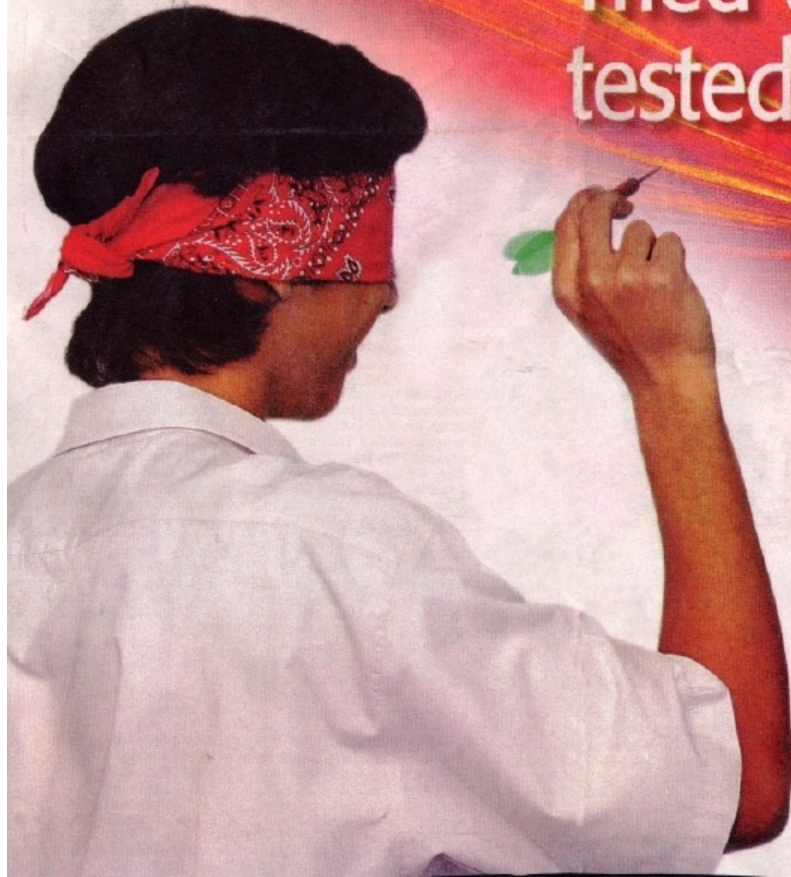



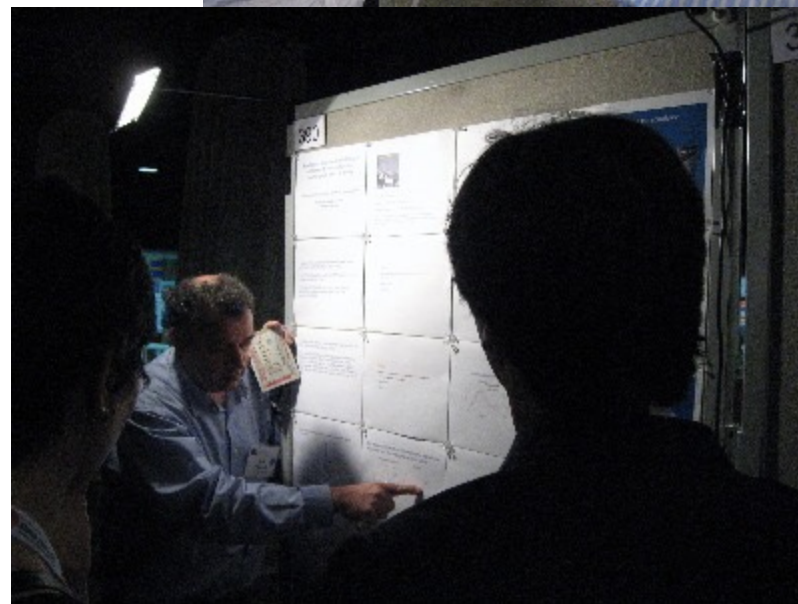
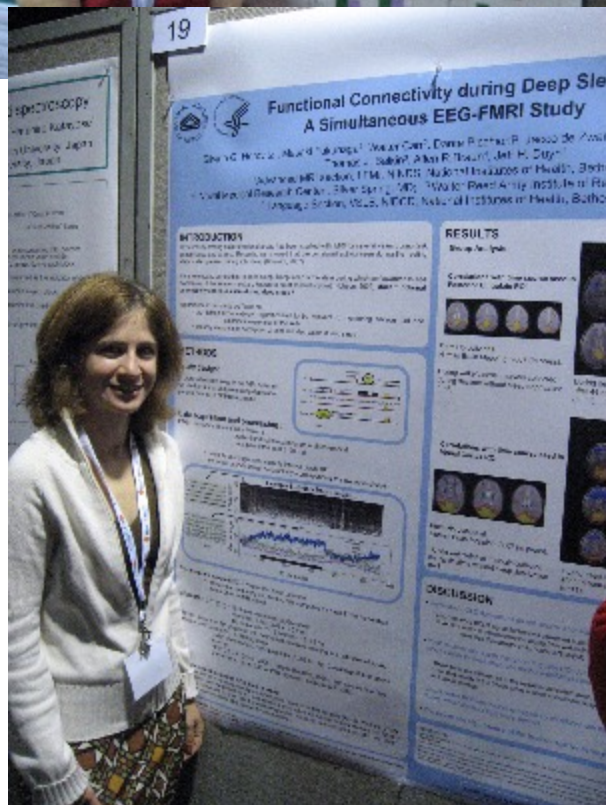
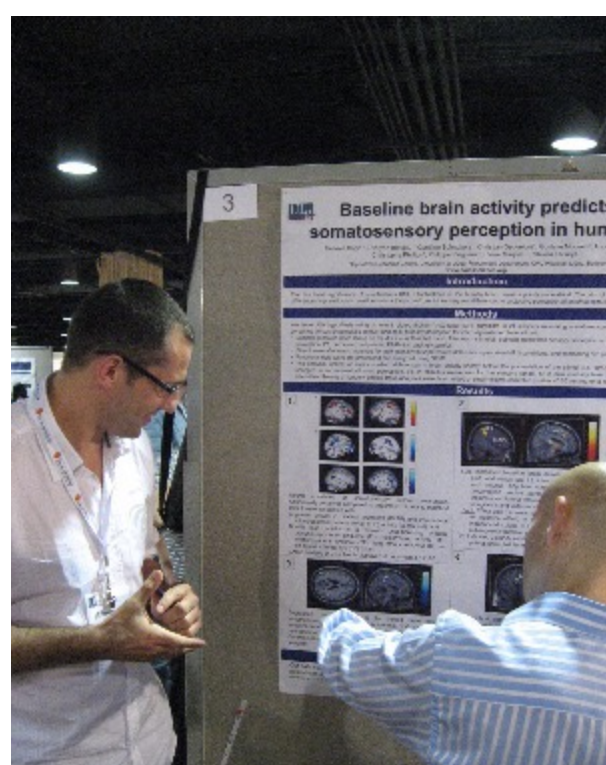
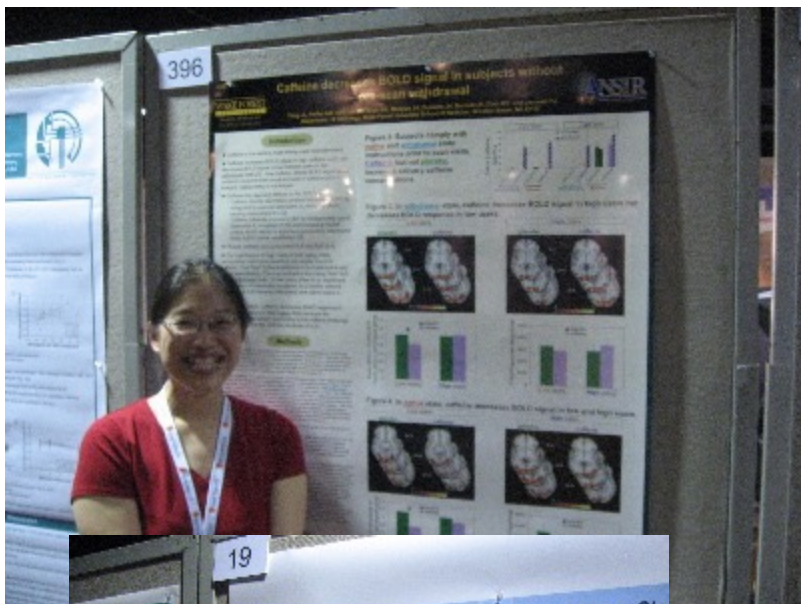





EGI





# Speakers Dinner



# Connor Anthony Bandettini



Thanks to...

Patrick Bellgowan

Rasmus Birn

Jerzy Bodurka

Niko Kriegeskorte

Sean Marrett

Kevin Murphy

Adam Thomas