

A closer look at fMRI

dynamics, fluctuations, and patterns

Peter A. Bandettini, Ph.D.

Section on Functional Imaging Methods
Laboratory of Brain and Cognition, NIMH
&
Functional MRI Facility, NIMH





1991

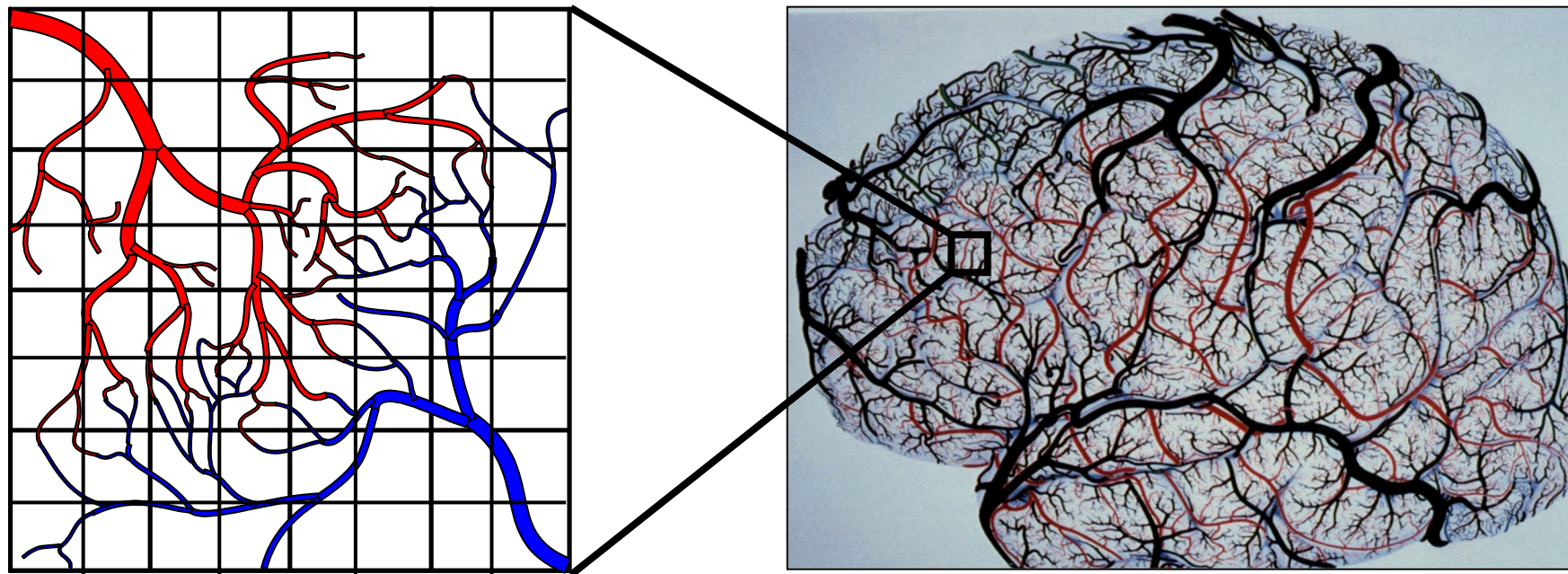
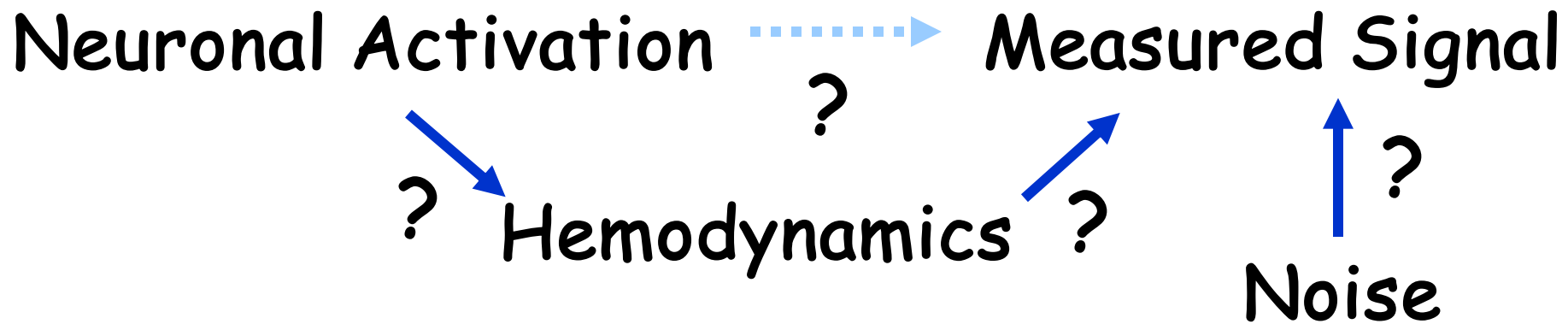

1. Dynamics

2. Fluctuations

3. Experimental Design

4. Pattern Information

5. Neuronal Current MRI

1. Dynamics

Motivation:

- To understand the neuronal and non-neuronal influences on the fMRI signal.

Studies:

- Modulate timing: "on" duration, "off" duration, and duty cycle of visual cortex activation.
- Neuronal and Hemodynamic Modeling.
- MEG and fMRI Comparison.

The BOLD Signal

Blood Oxygenation Level Dependent (BOLD) signal changes

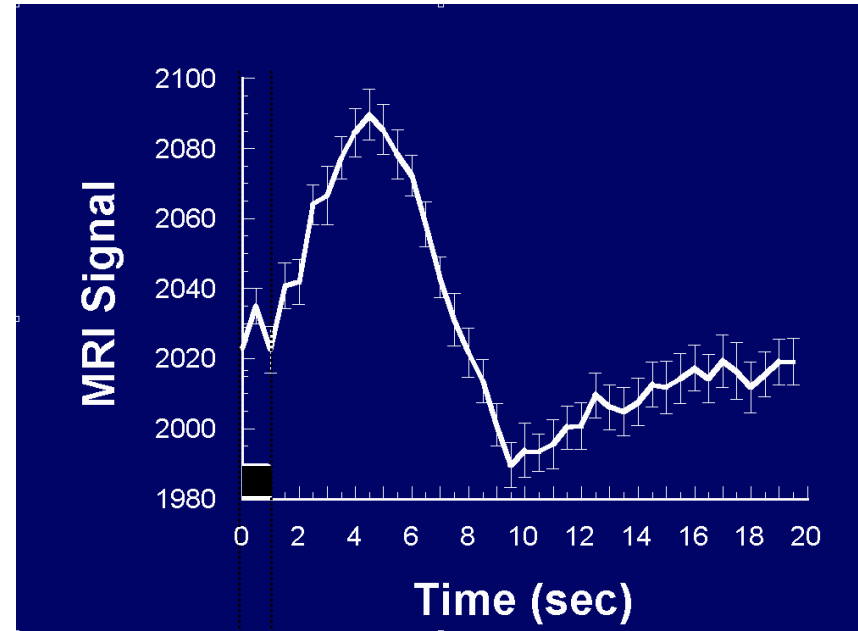
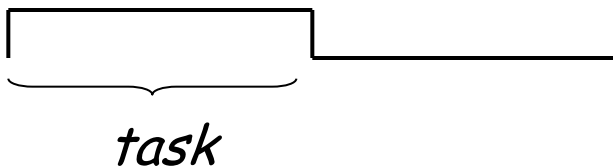
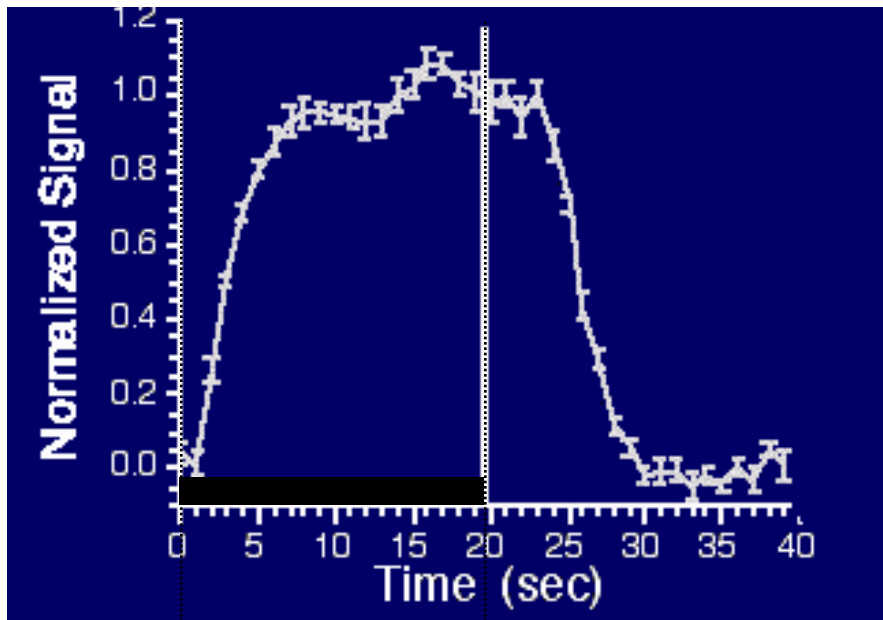

Brief "on" periods produce **larger** increases than expected.

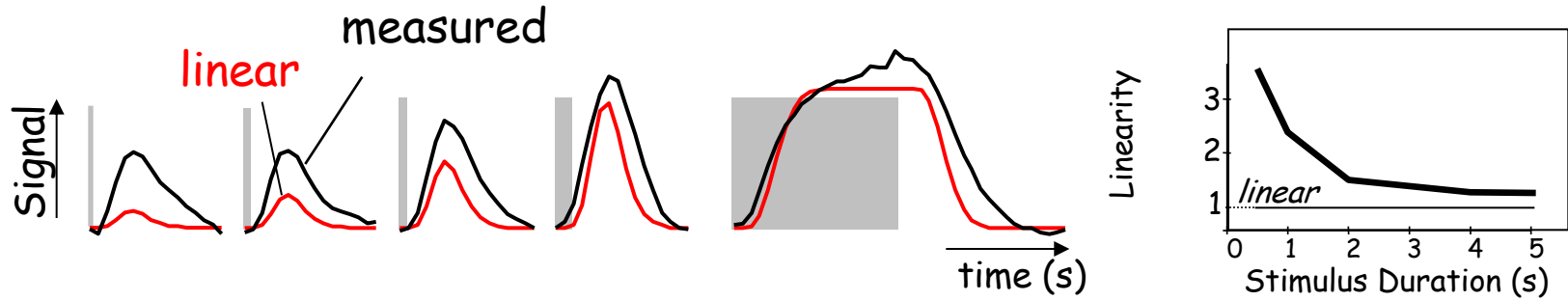

R. M. Birn, Z. Saad, P. A. Bandettini, *NeuroImage*, 14: 817-826, (2001)

Brief "off" periods produce **smaller** decreases than expected.

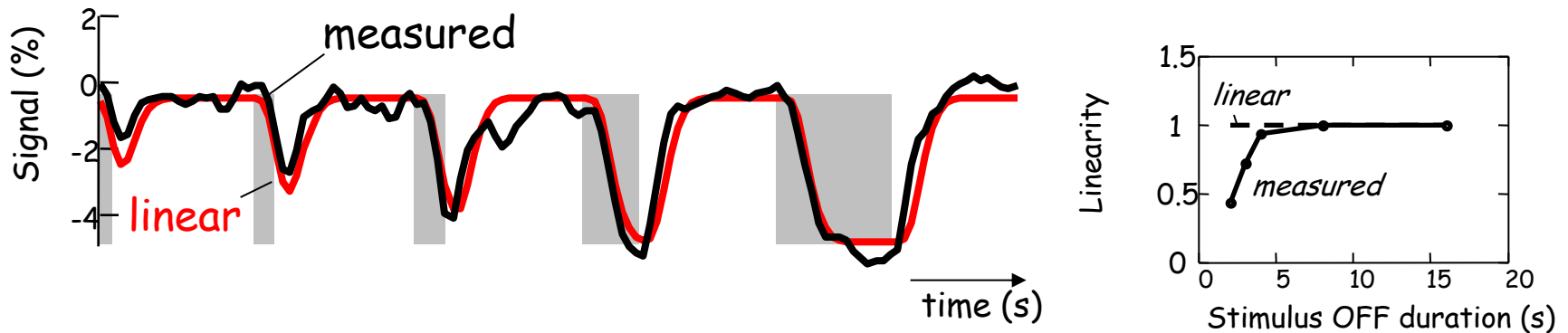

R.M. Birn, P. A. Bandettini, *NeuroImage*, 27, 70-82 (2005)

Varying the Duty Cycle

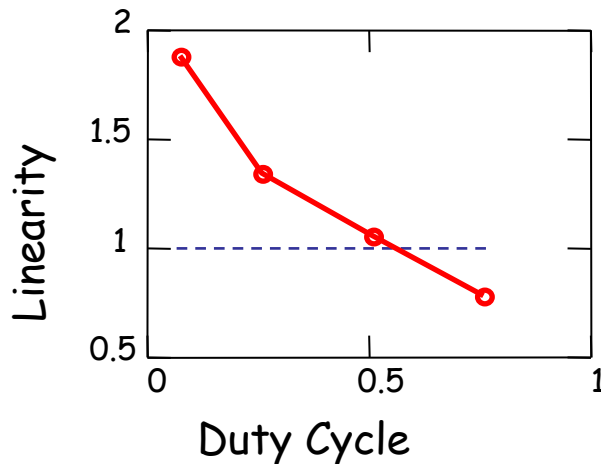
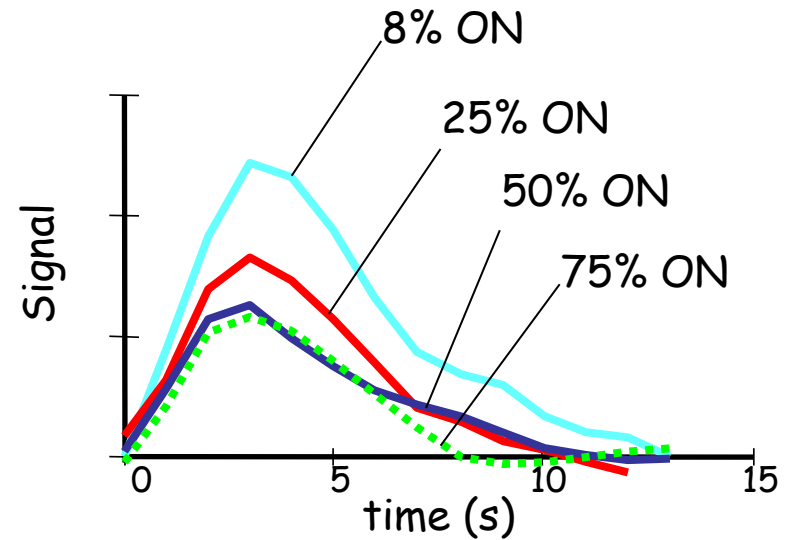
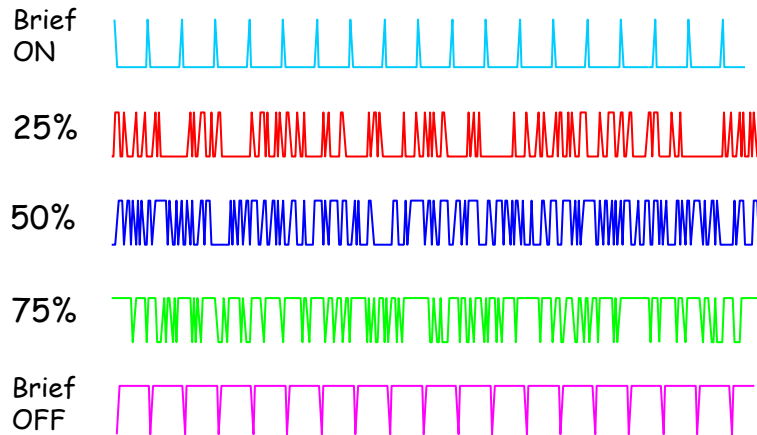

Simulation of Hemodynamic Mechanisms (Balloon model)

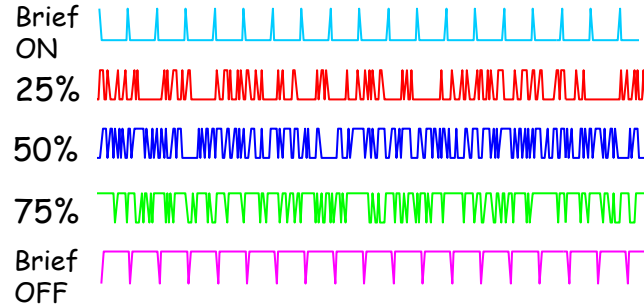
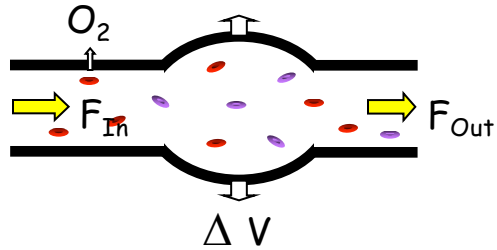

$E(f)$ = oxygen extraction fraction

V = blood volume

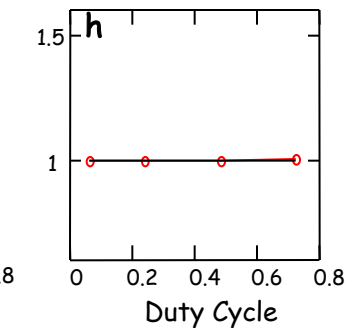
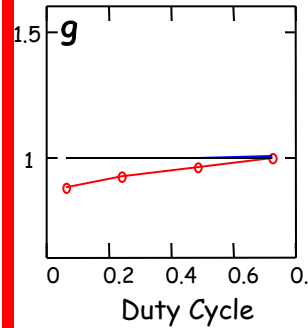
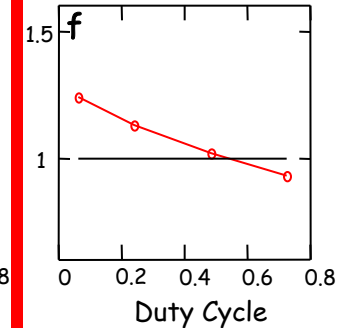
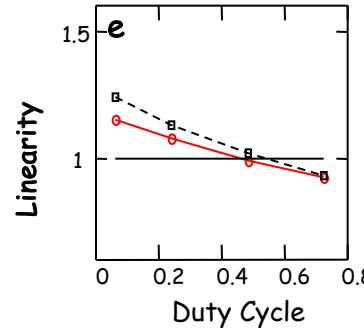
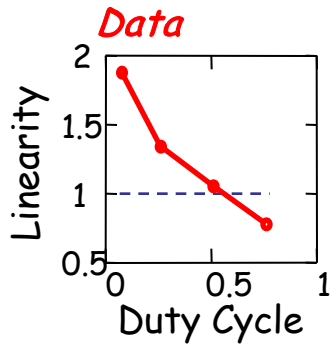
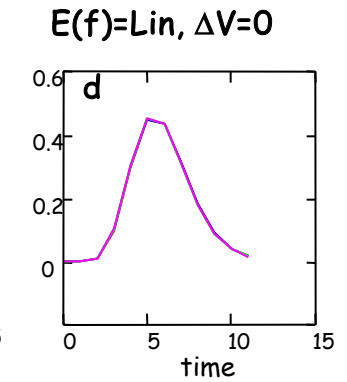
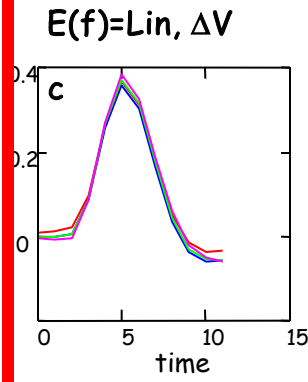
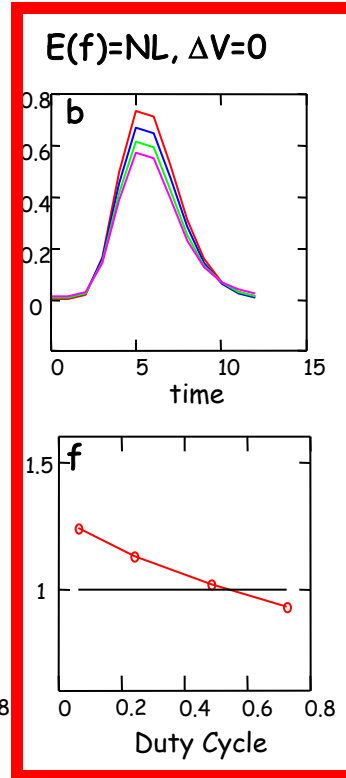
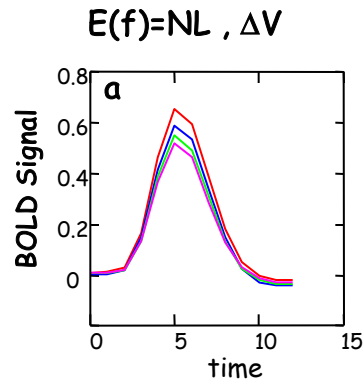

Simulation of Neuronal Mechanisms

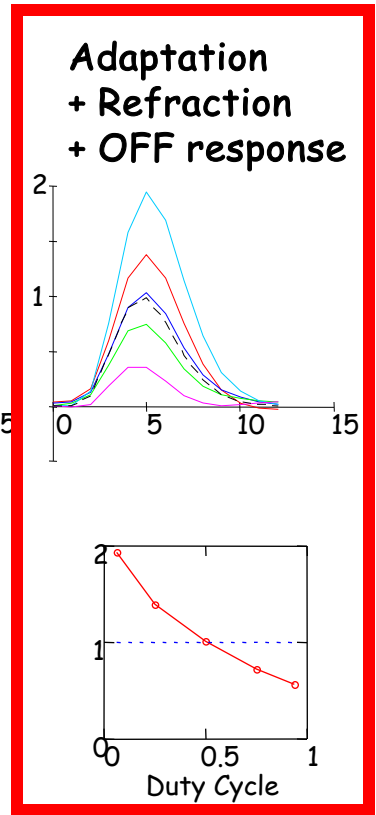
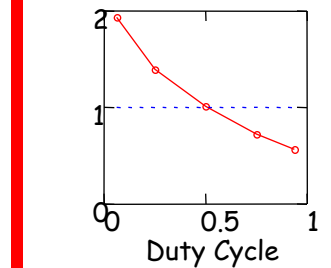
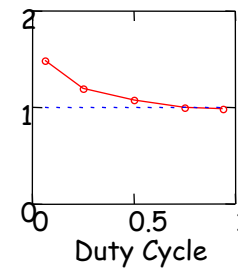
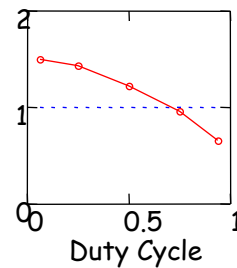
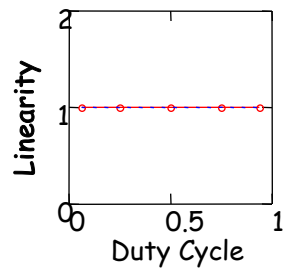
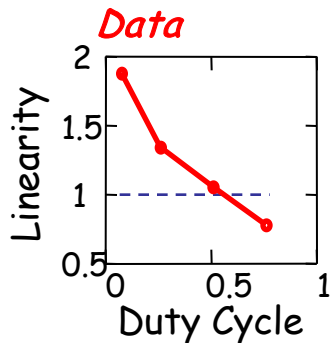
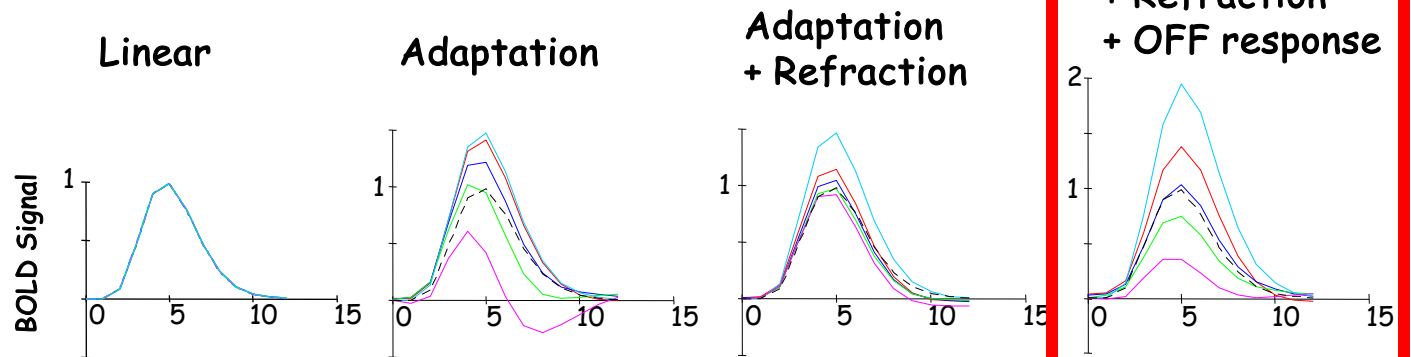
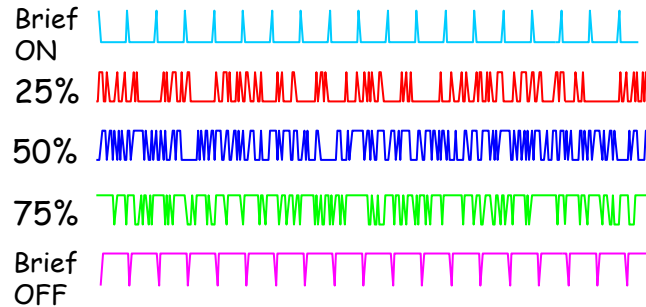
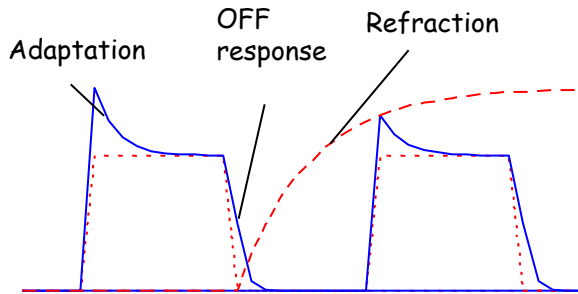

MEG & fMRI Linearity Comparison

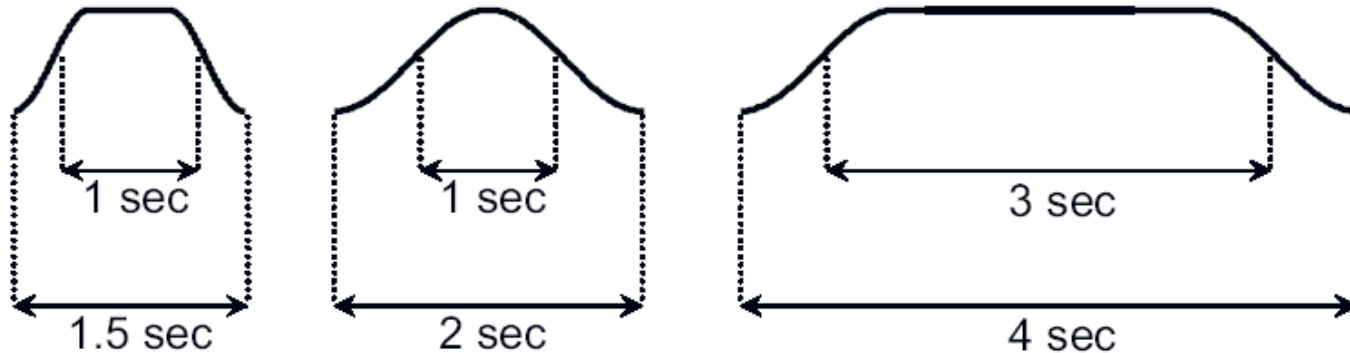
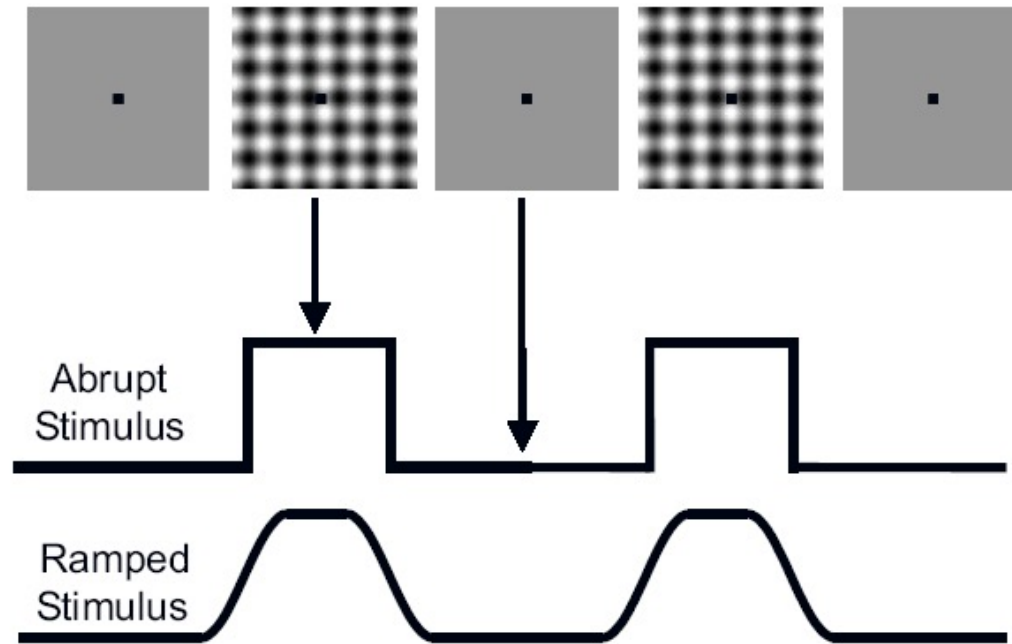

MEG Results

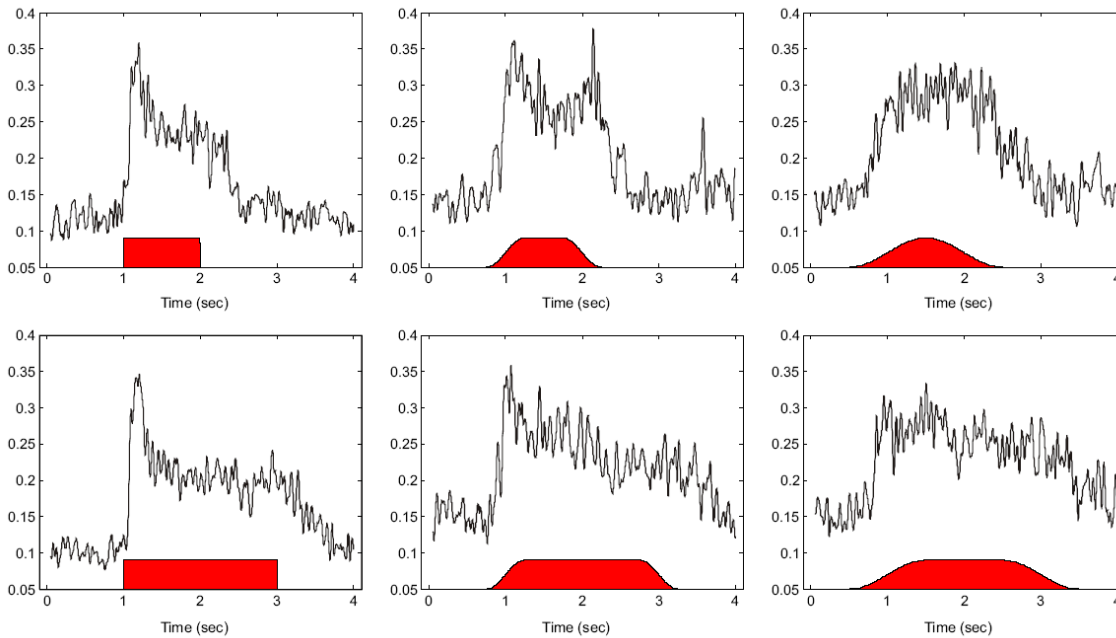
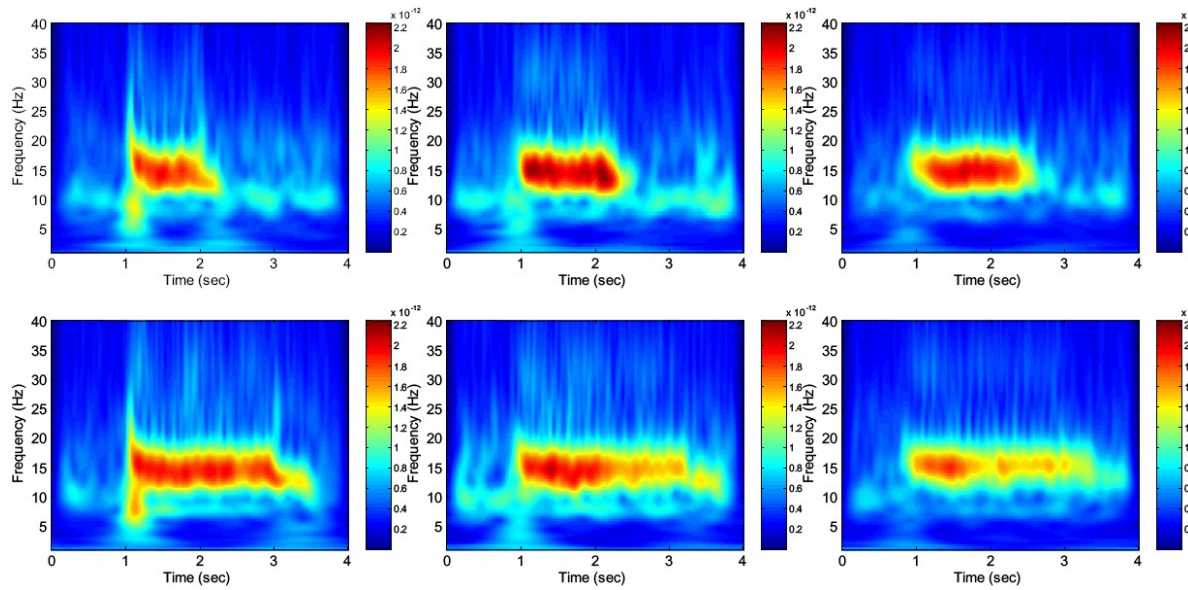

A. Tuan, R. M. Birn, P. A. Bandettini, G. M. Boynton, (submitted)

Measured and Predicted BOLD responses

BOLD

MEG

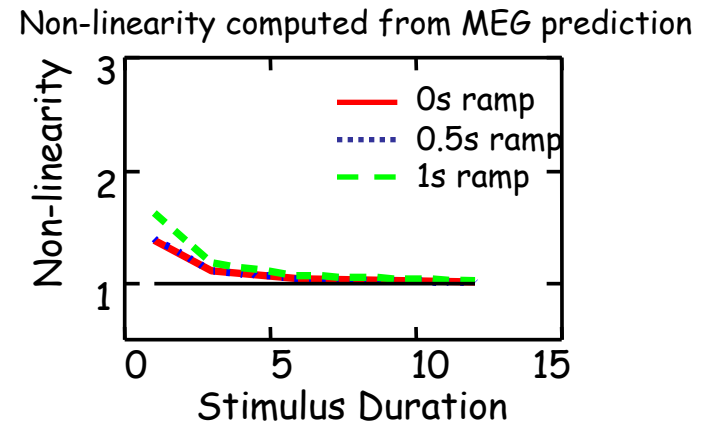
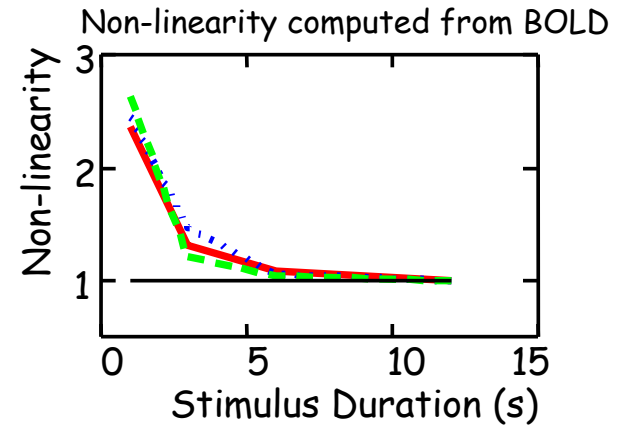
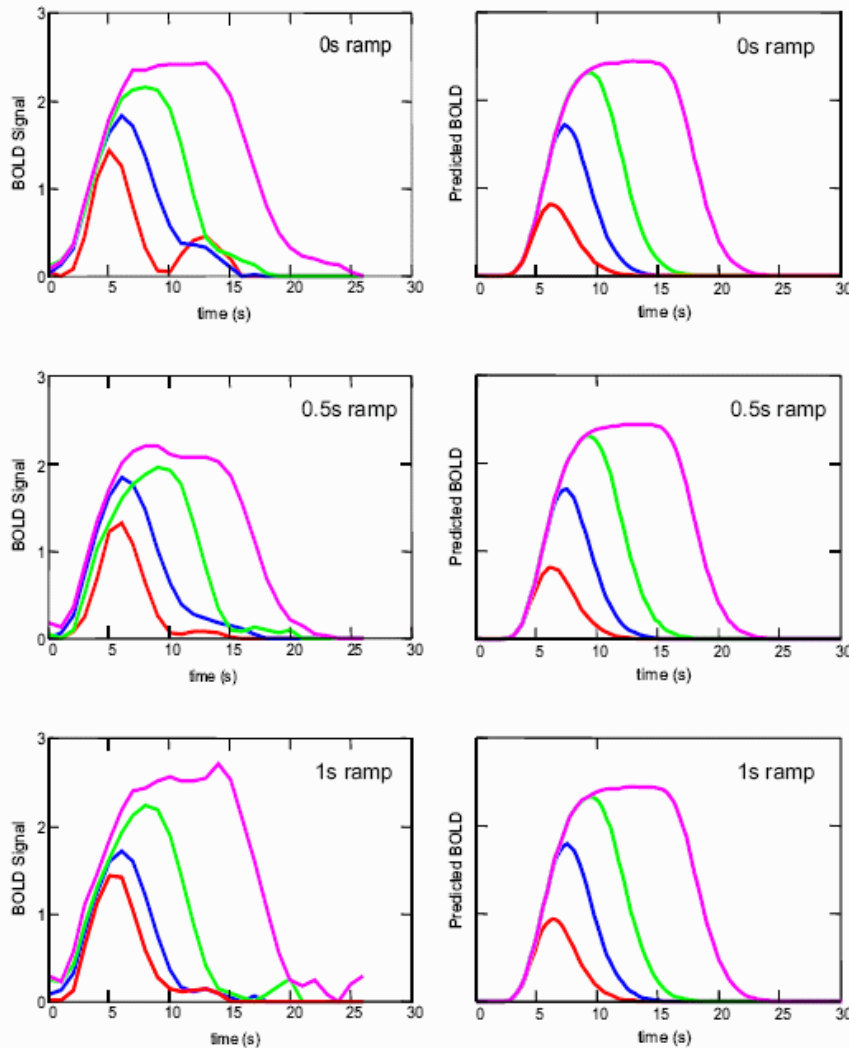

2. Fluctuations

Motivation:

- Applications of connectivity mapping (autism, schizophrenia, Alzheimer's, ADHD) have exploded - need for better interpretation.
- Distinguish neuronal activity-related fluctuations from non-neuronal physiological fluctuations.
 - reduce false positives in resting state connectivity maps*
 - increase functional contrast to noise for activation maps*
- *fMRI activation magnitude* calibration using fluctuations rather than hypercapnic or breath-hold stress.

Studies:

- Time course of respiration volume per unit time (RVT)
- The Respiration Response Function (RRF)
- fMRI Calibration using RRF

Resting State Correlations

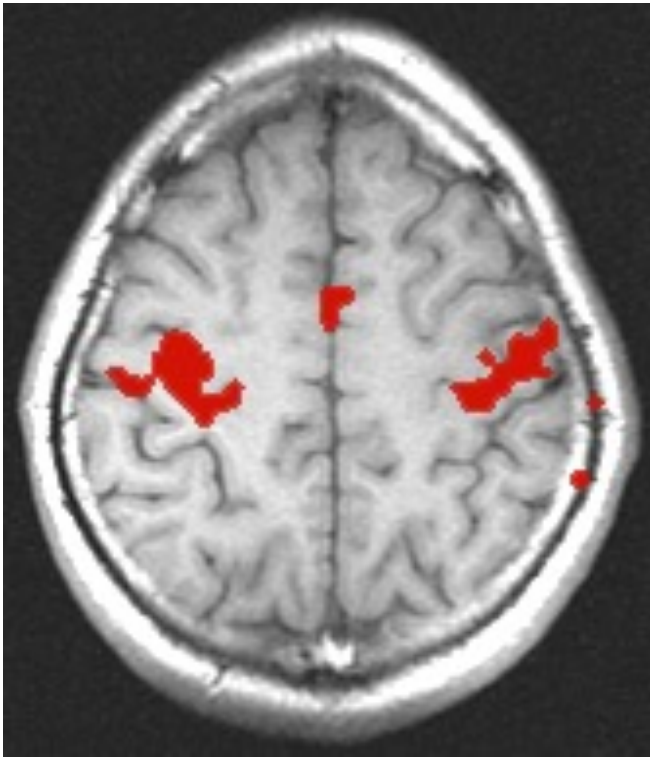

Activation:
correlation with reference function

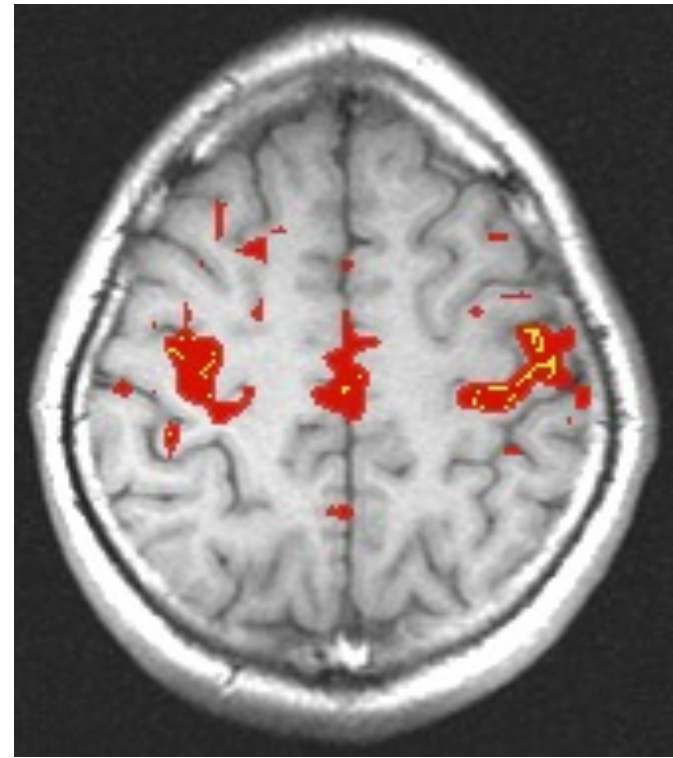

Rest:
seed voxel in motor cortex

BOLD correlated with SCR during "Rest"

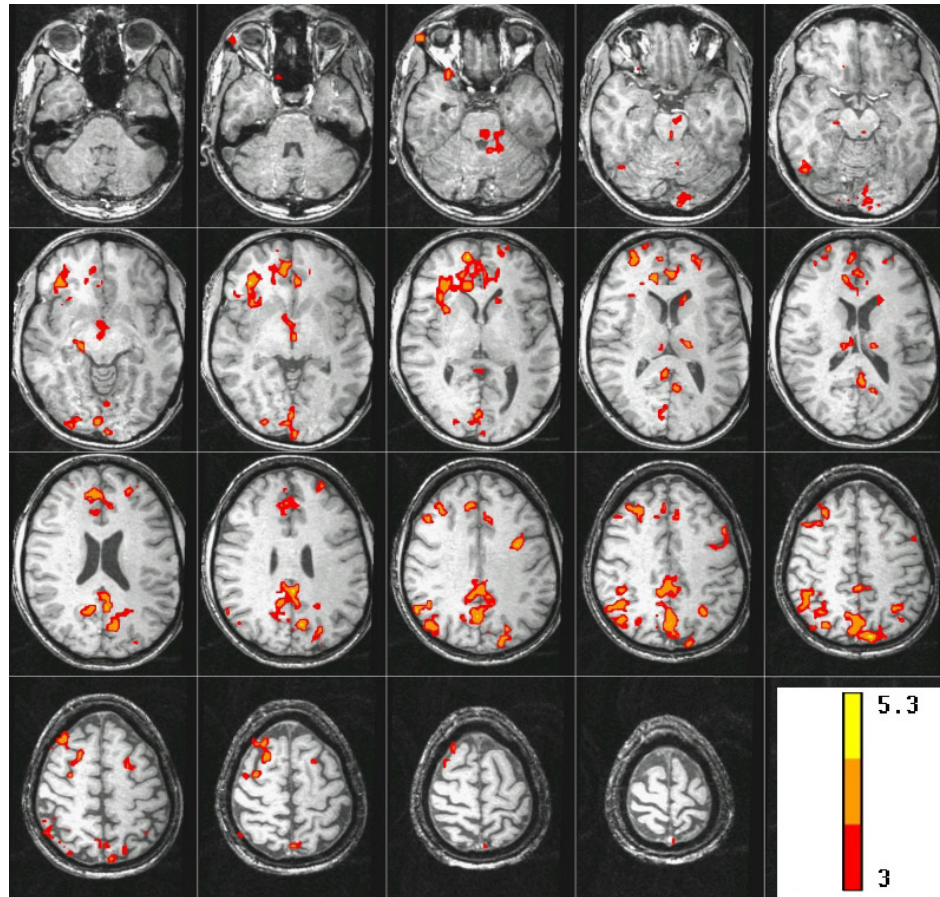

J. C. Patterson II, L. G. Ungerleider, and P. A. Bandettini,
NeuroImage 17: 1787-1806, (2002).

Methodology

Resting state networks identified with ICA

M. DeLuca, C.F. Beckmann, N. De Stefano, P.M. Matthews, S.M. Smith, *fMRI resting state networks define distinct modes of long-distance interactions in the human brain*. *NeuroImage*, 29, 1359-1367

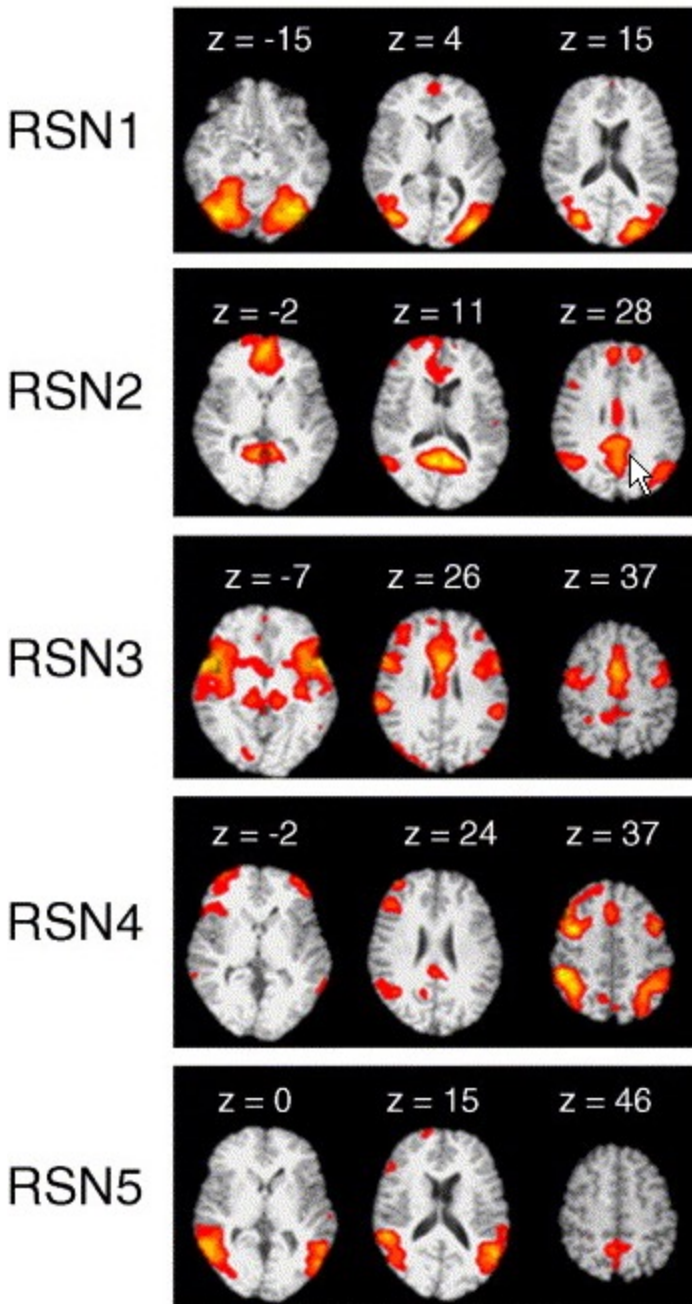
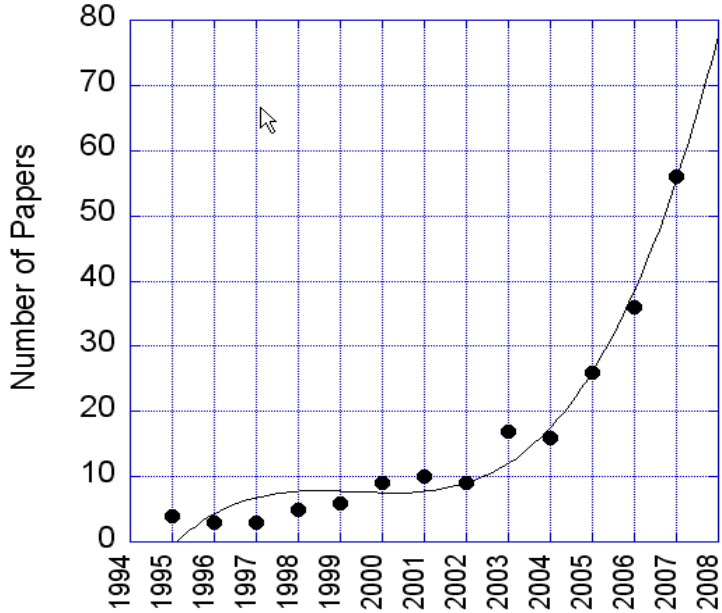

Sources of time series fluctuations:

- Blood, brain and CSF pulsation
- Vasomotion
- Breathing cycle (B_0 shifts with lung expansion)
- Bulk motion
- Scanner instabilities
- Changes in blood CO_2 (changes in breathing)
- Spontaneous neuronal activity

Breath-holding Group Maps (N = 7)

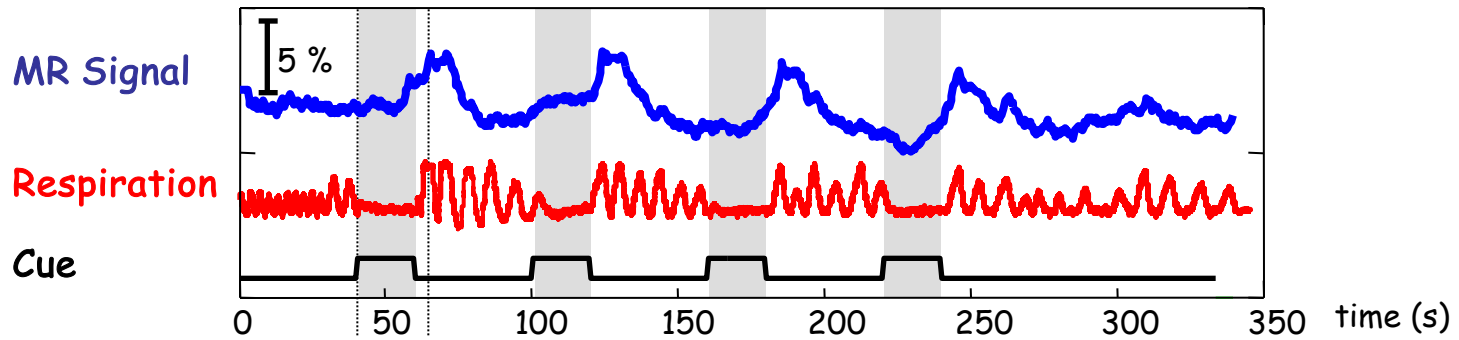

Anatomy

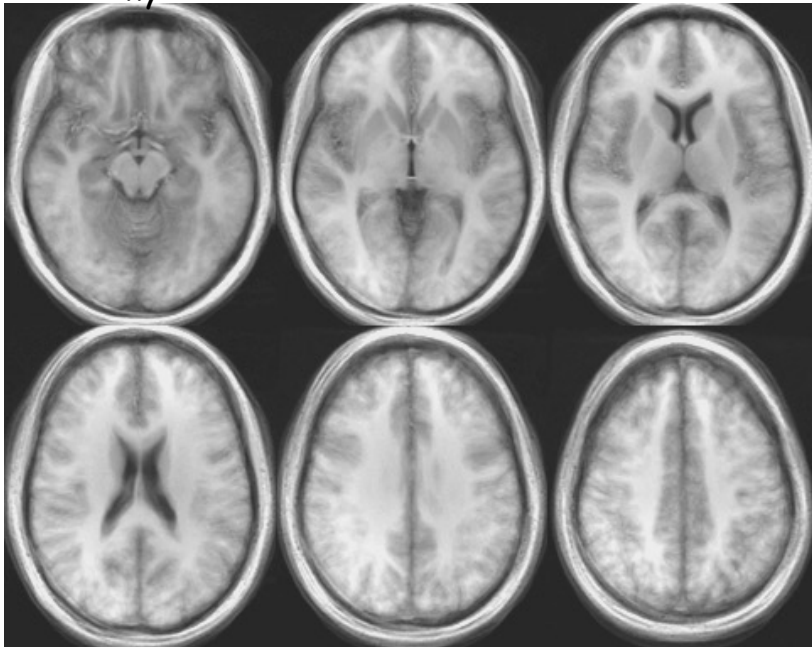

Breath-hold response (average Z-score)

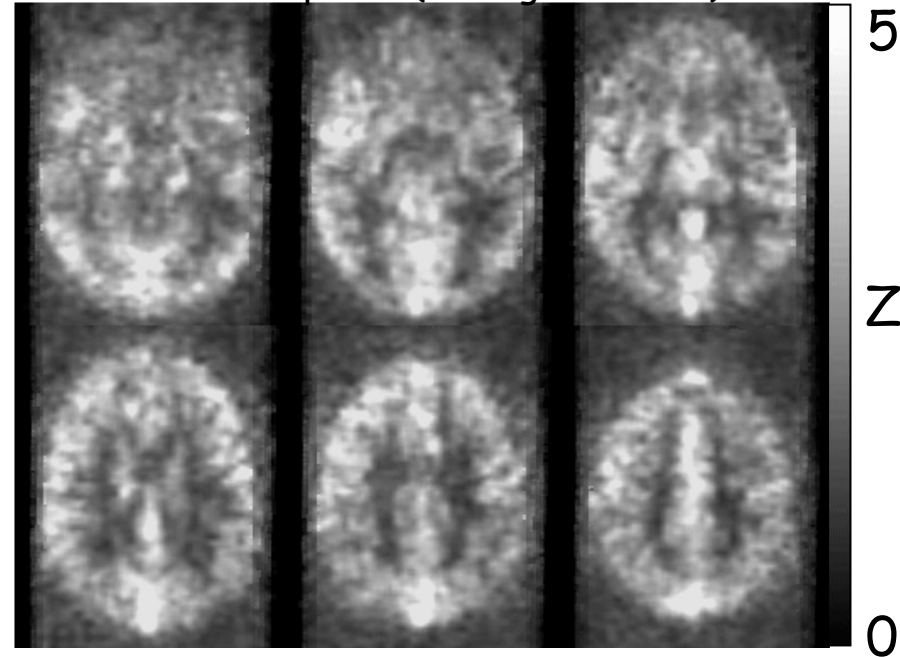

Estimating respiration volume changes

Respiration

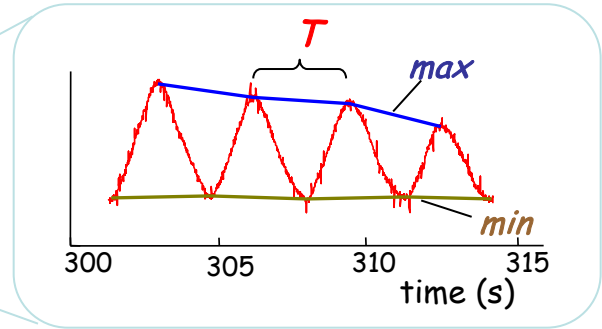
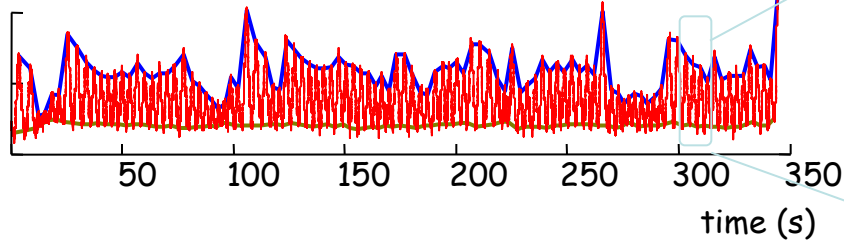

Respiration Volume / Time (RVT)

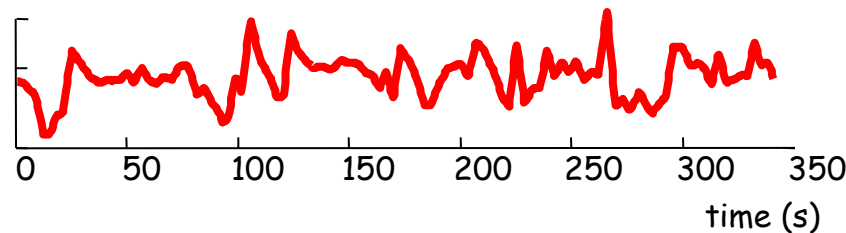

$$RVT = \frac{\text{max} - \text{min}}{T}$$

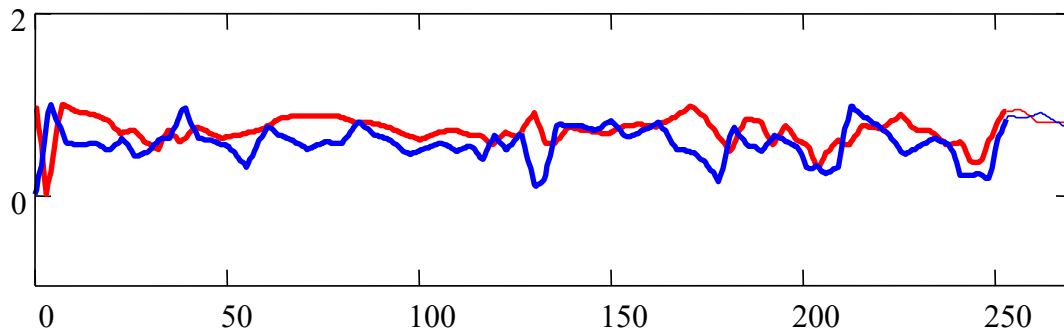

— CO₂
— RVT

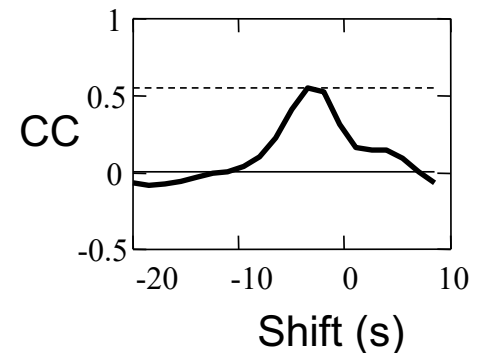

RVT precedes end tidal CO₂ by 5 sec.

Respiration induced signal changes

Rest

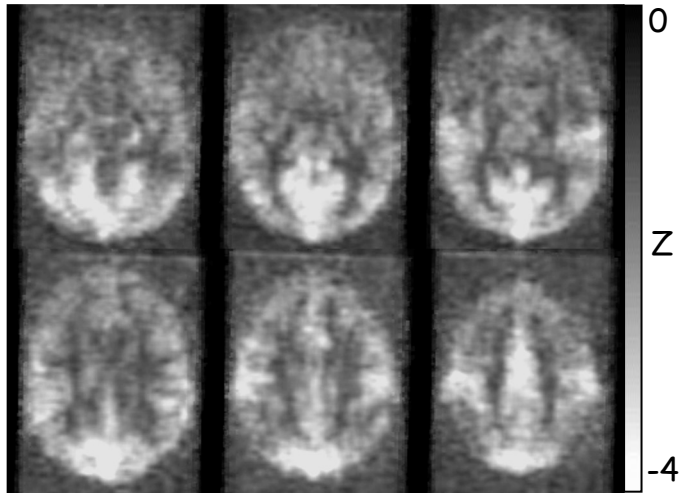

Breath-holding

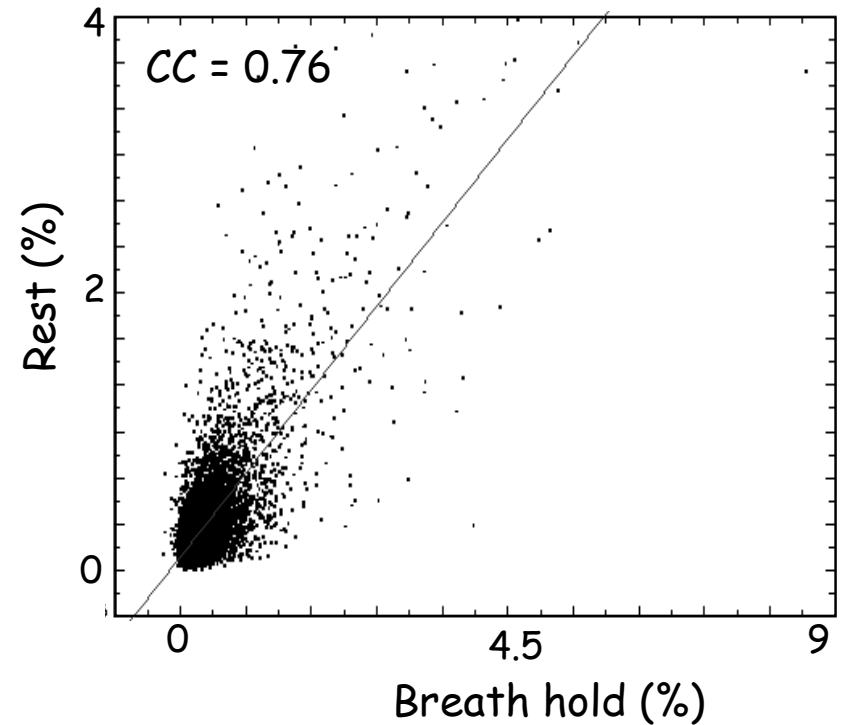
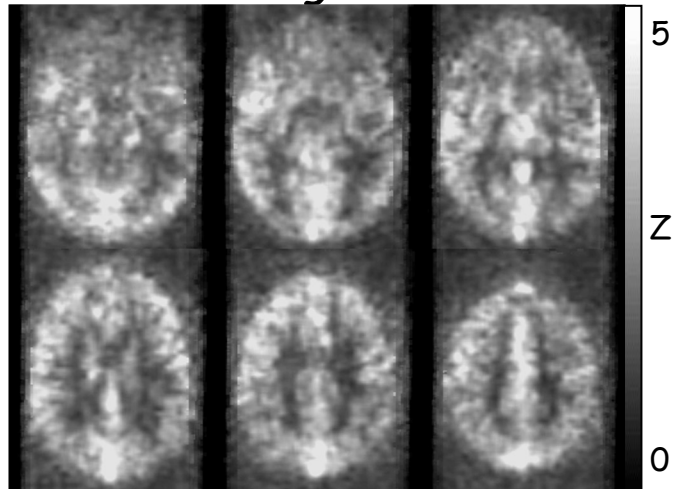

(N=7)

Respiration induced signal changes

Breath-holding

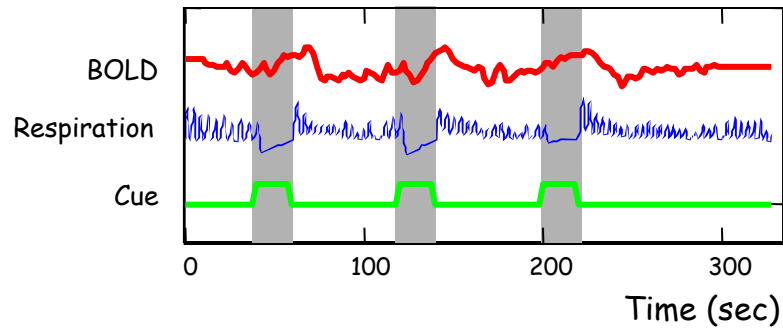

Rest

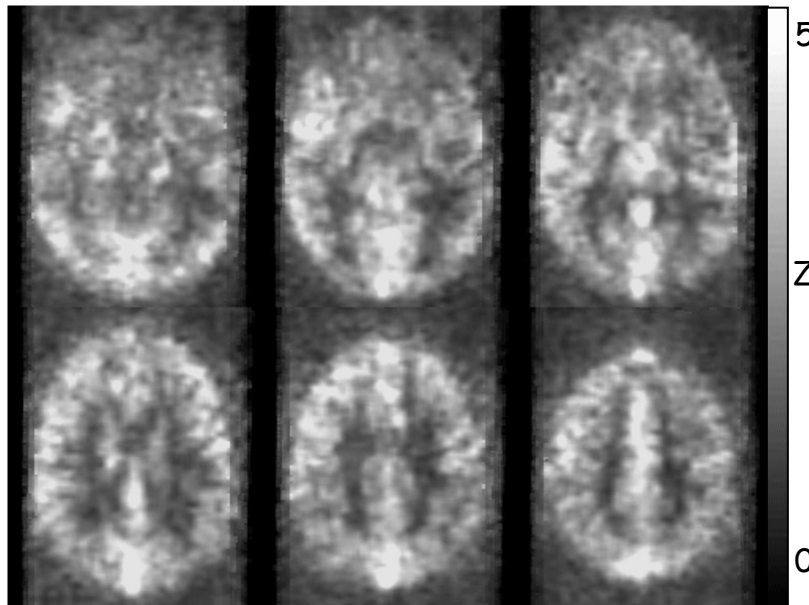
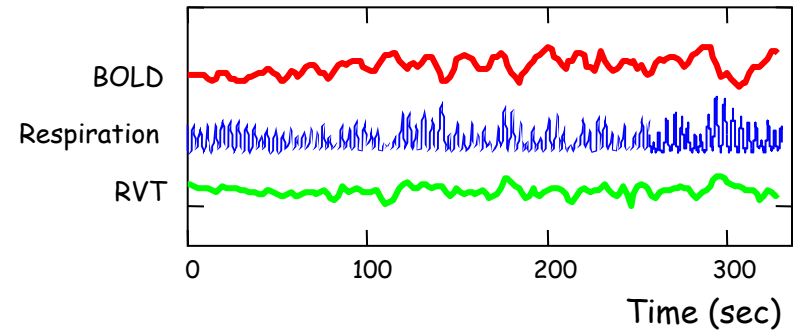

(N=7)

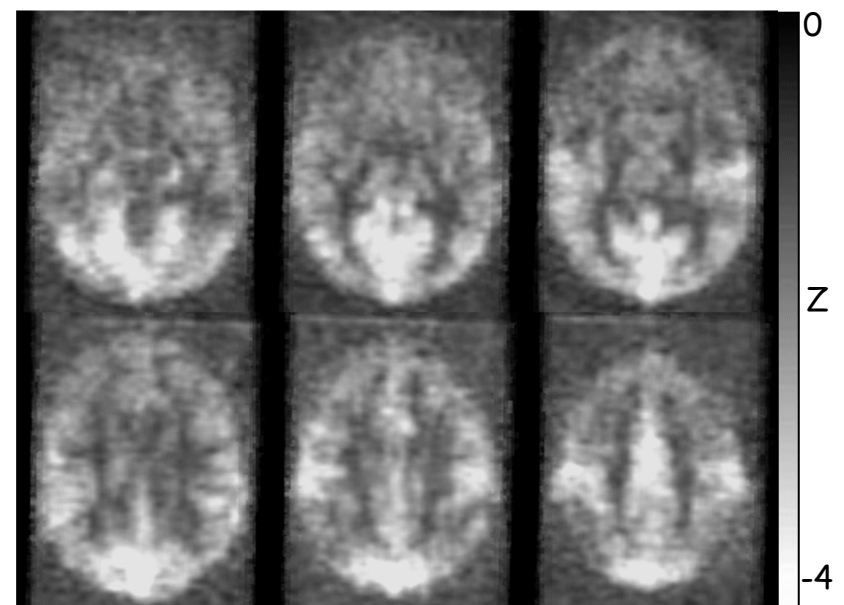

RVT Correlation Maps & Functional Connectivity Maps

Resting state correlation with signal from posterior cingulate

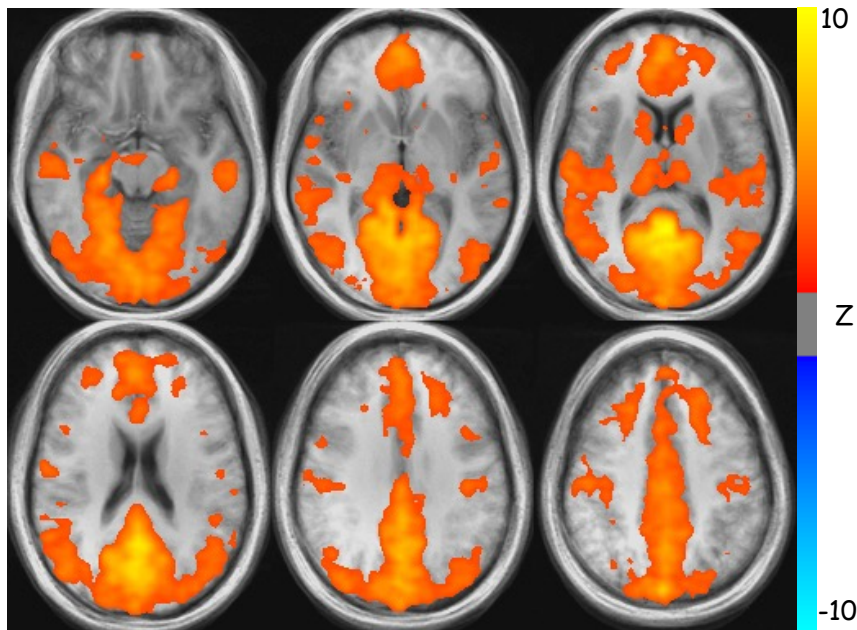

Resting state correlation with RVT signal

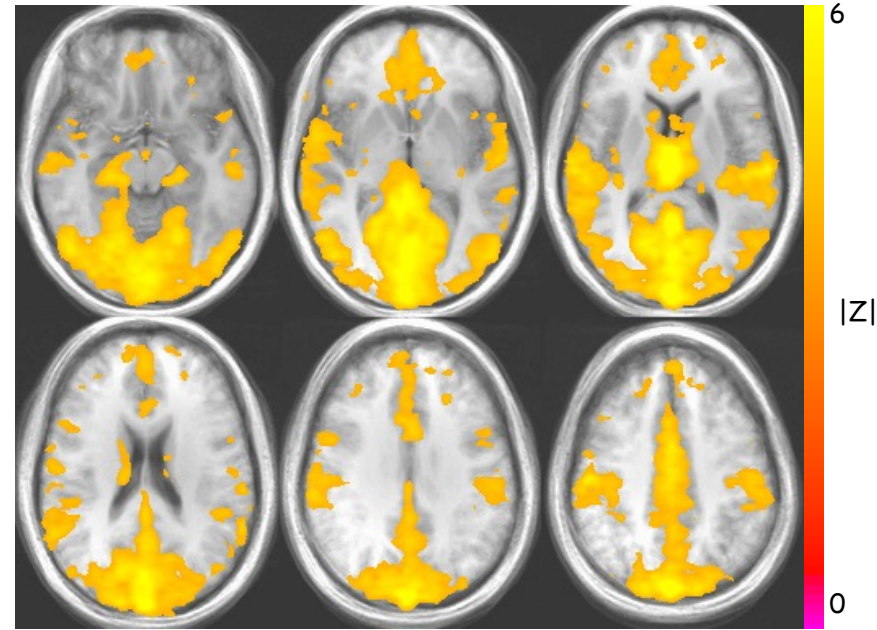

Group (n=10)

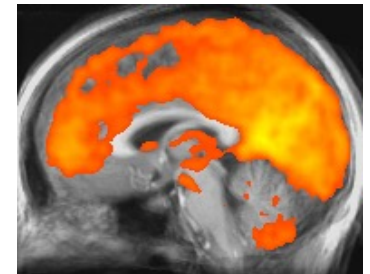

R.M. Birn, J. A. Diamond, M. A. Smith, P. A. Bandettini,
NeuroImage, 31, 1536-1548 (2006)

Effect of Respiration Rate Consistency on Resting Correlation Maps

Spontaneously Varying Respiration Rate

Constant Respiration Rate

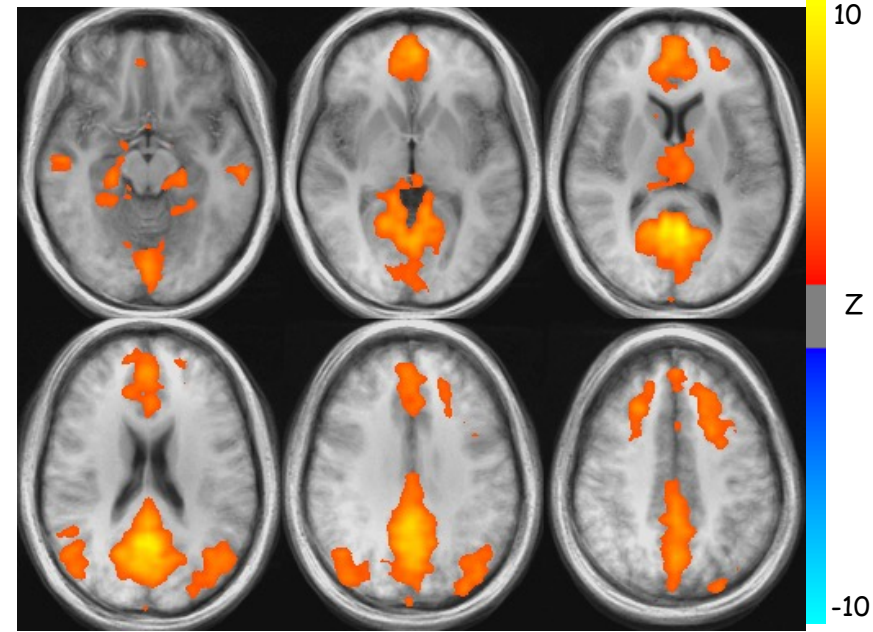
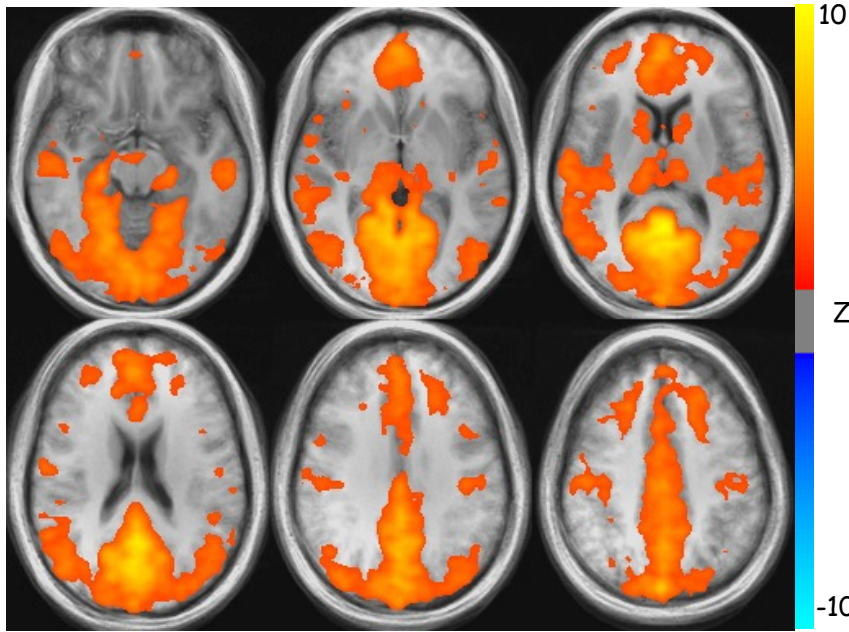

Lexical Decision Making Task

Group (n=10)

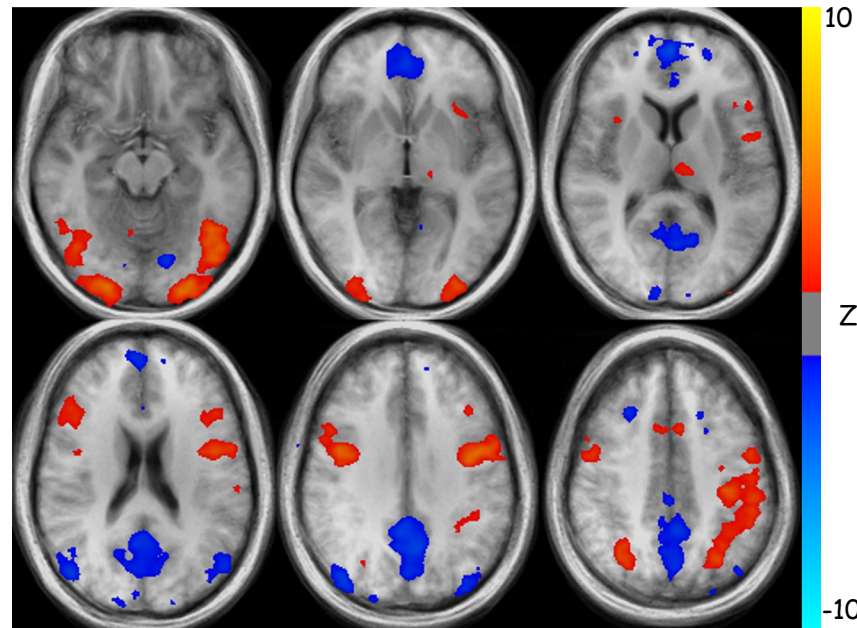

Blue: deactivated network

Respiration Changes vs. BOLD

How are the BOLD changes related to respiration variations?

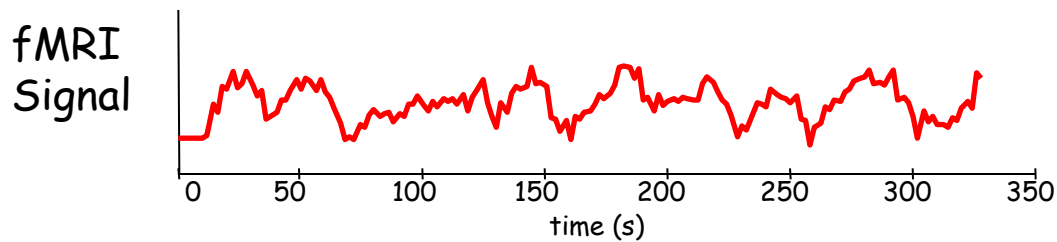
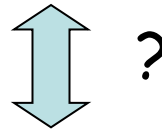
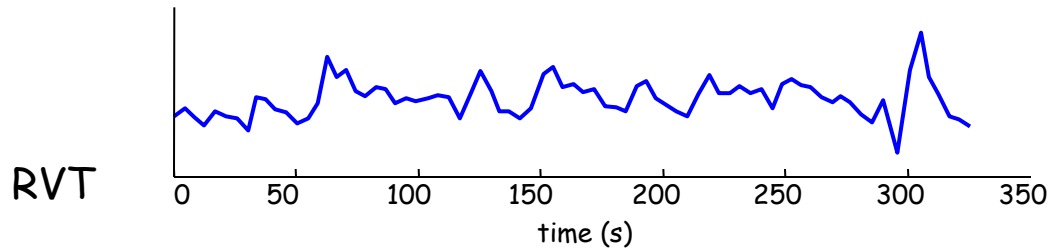

fMRI response to a single Deep Breath

Respiration

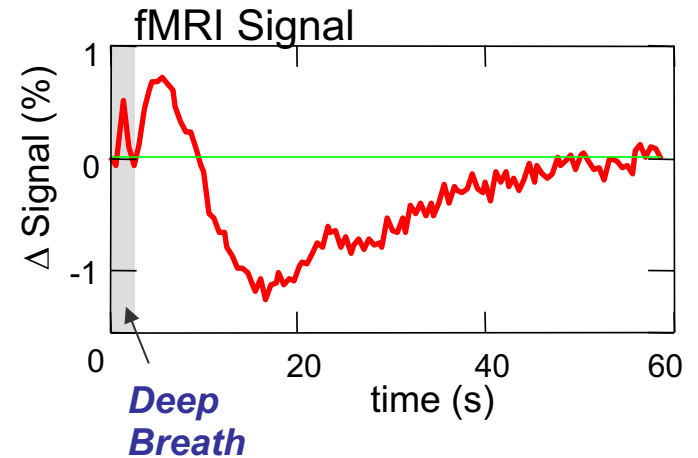
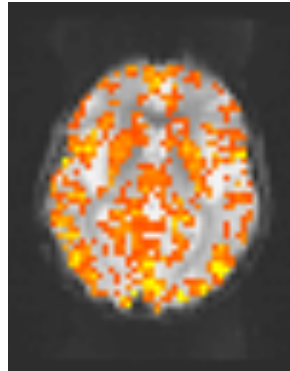
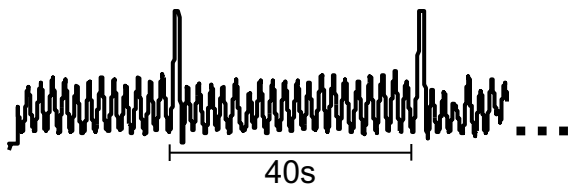

$$\text{RRF}(t) = 0.6 t^{2.1} e^{-1.6 t} - 0.0023 t^{3.54} e^{-4.25 t}$$

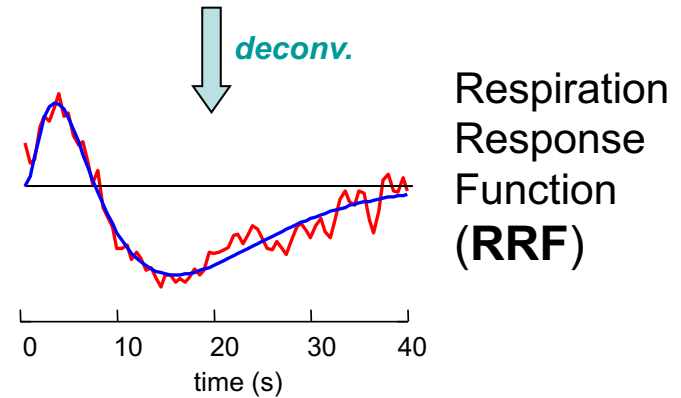

Respiration response function predicts BOLD signal associated with breathing changes better than activation response function.

Breath-holding

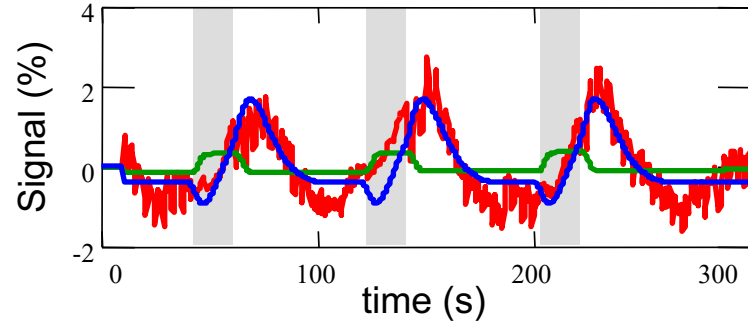
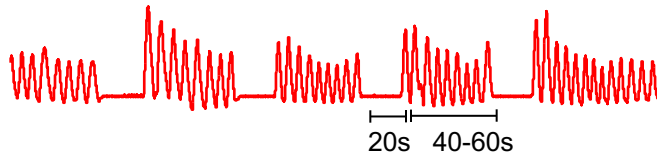

Rate Changes

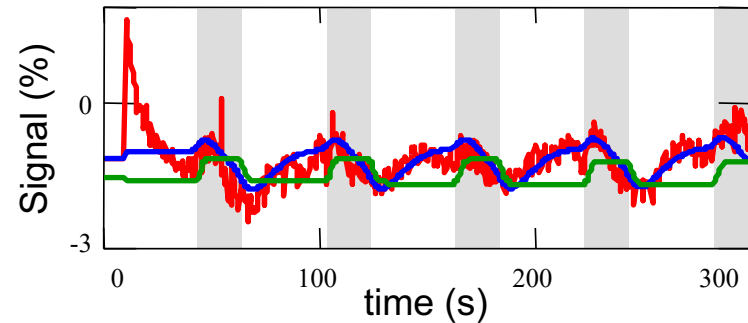
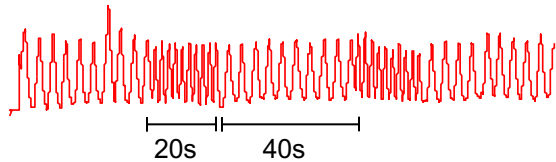

Depth Changes

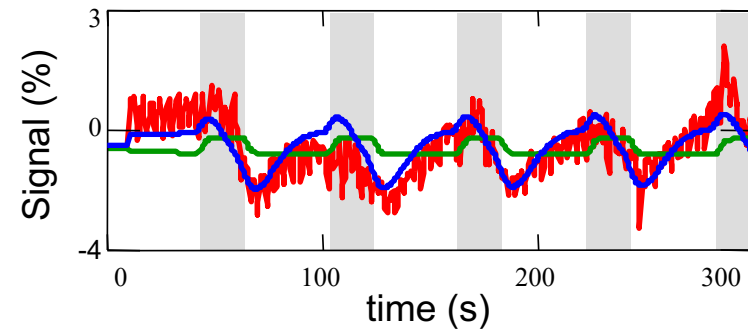
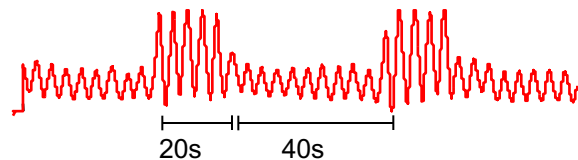

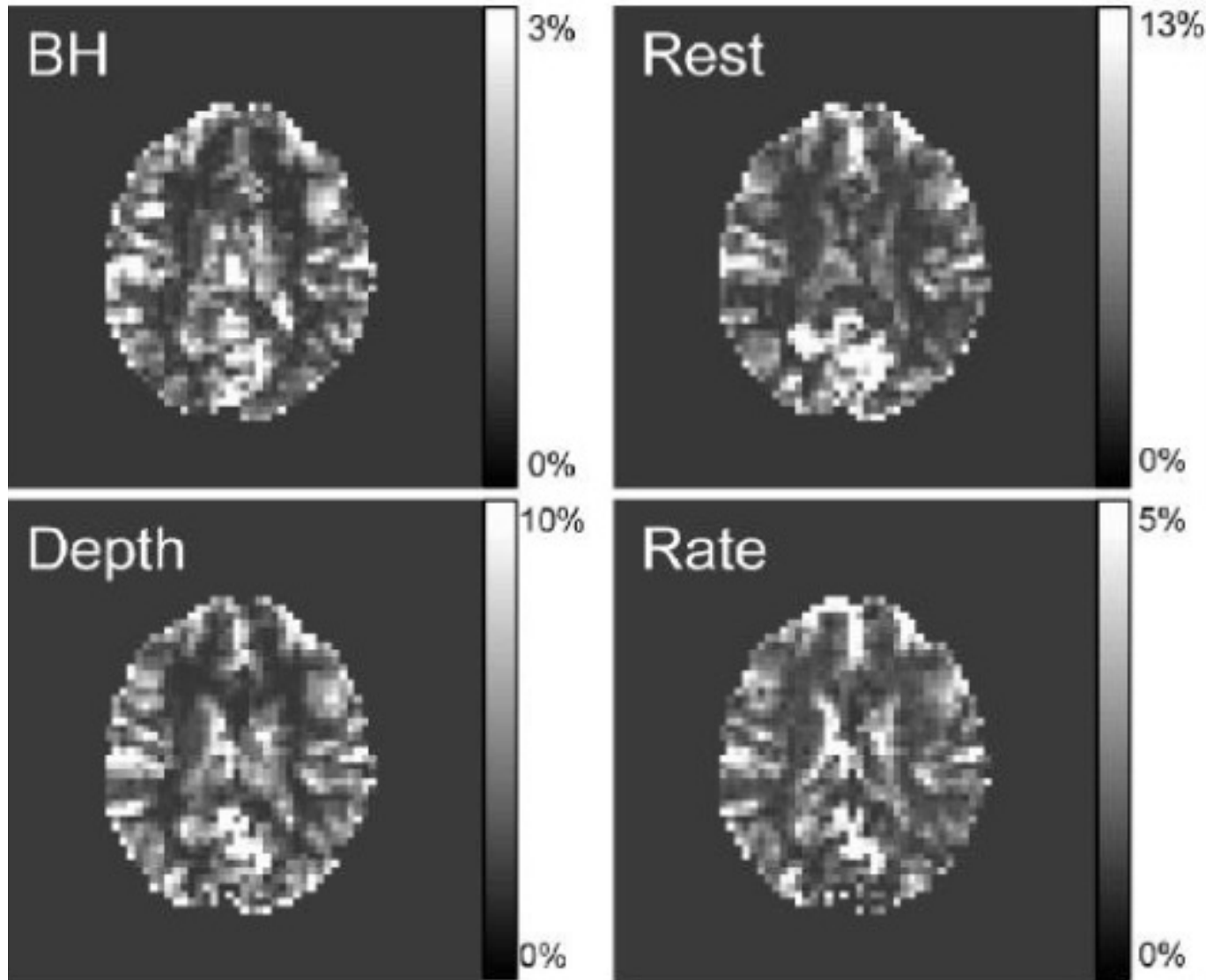

BOLD magnitude calibration

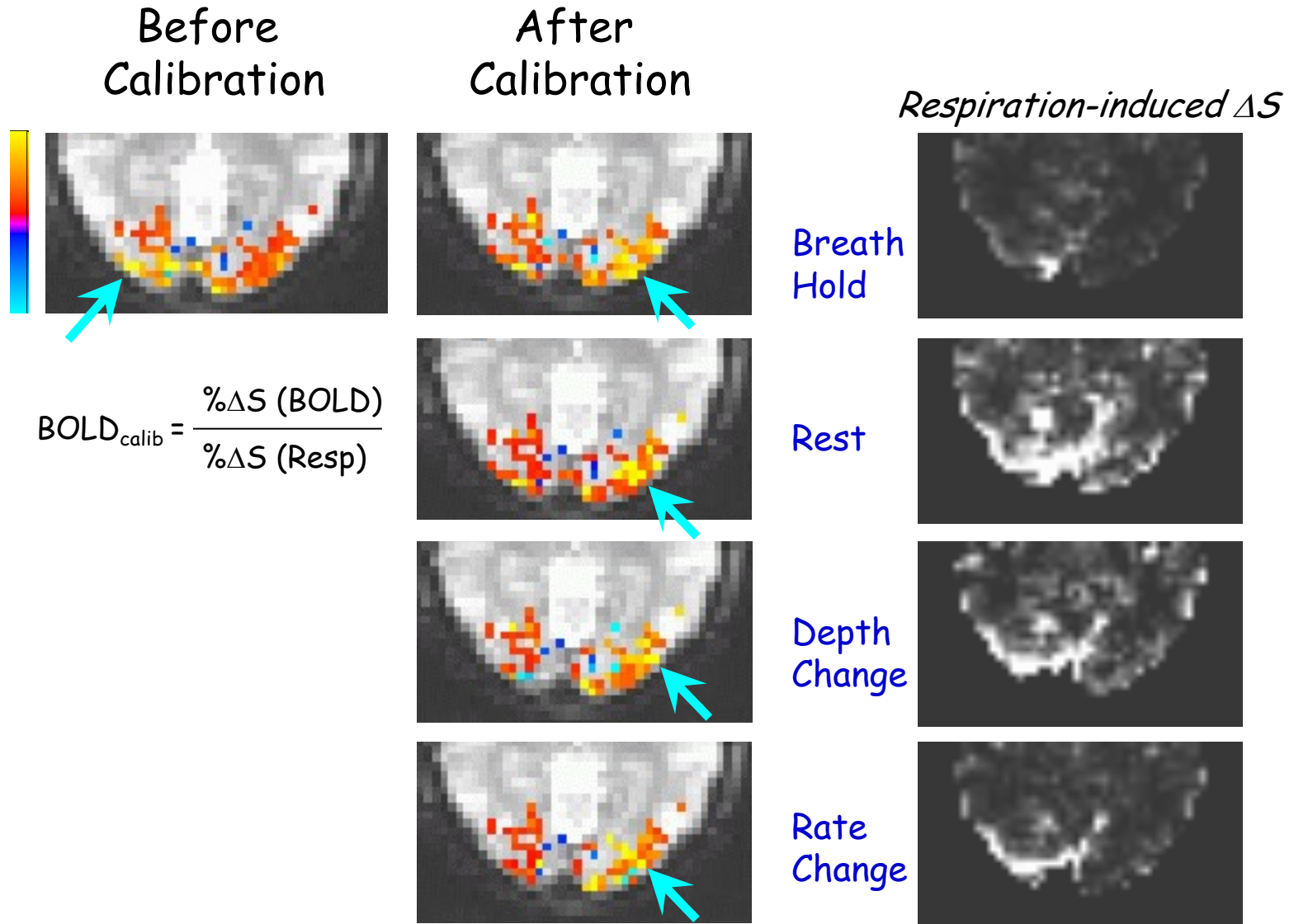

3. Experimental Design

Motivation:

- Guides for *individual* subject scanning at the limits of detectability, resolution, available time, and subject performance.

Studies:

- Overt response timing
- Suggested resolution

fMRI during tasks that involve brief motion

Blocked Design

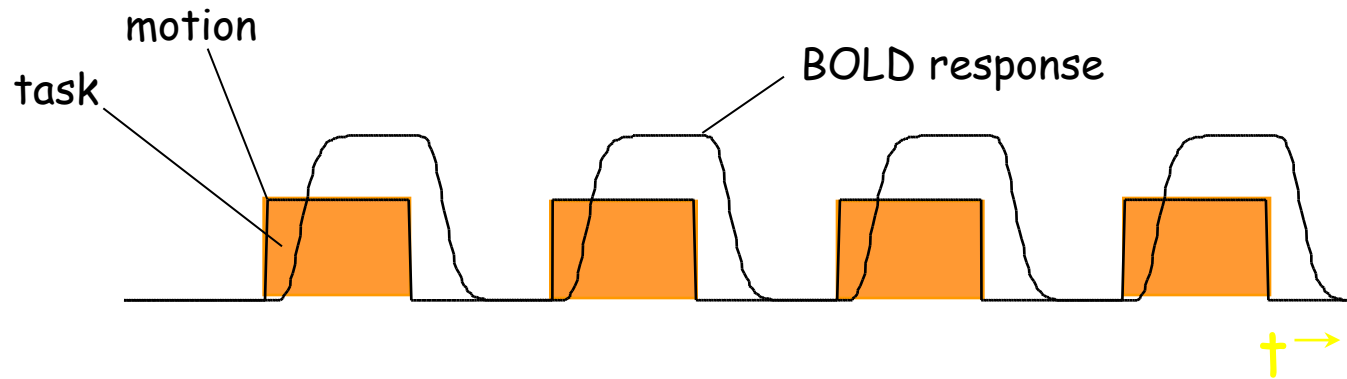

Event-Related Design

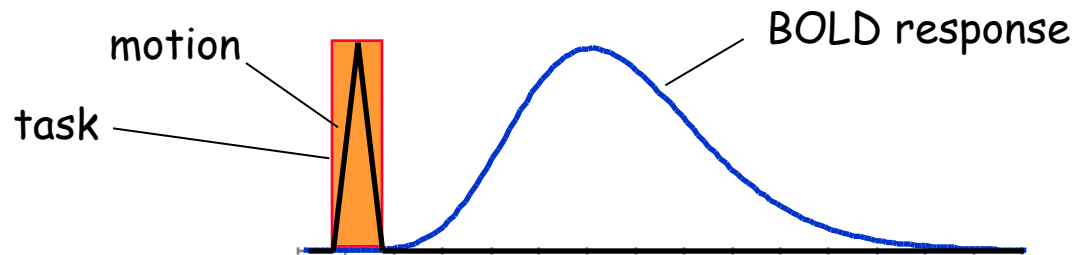

Overt Responses - Simulations

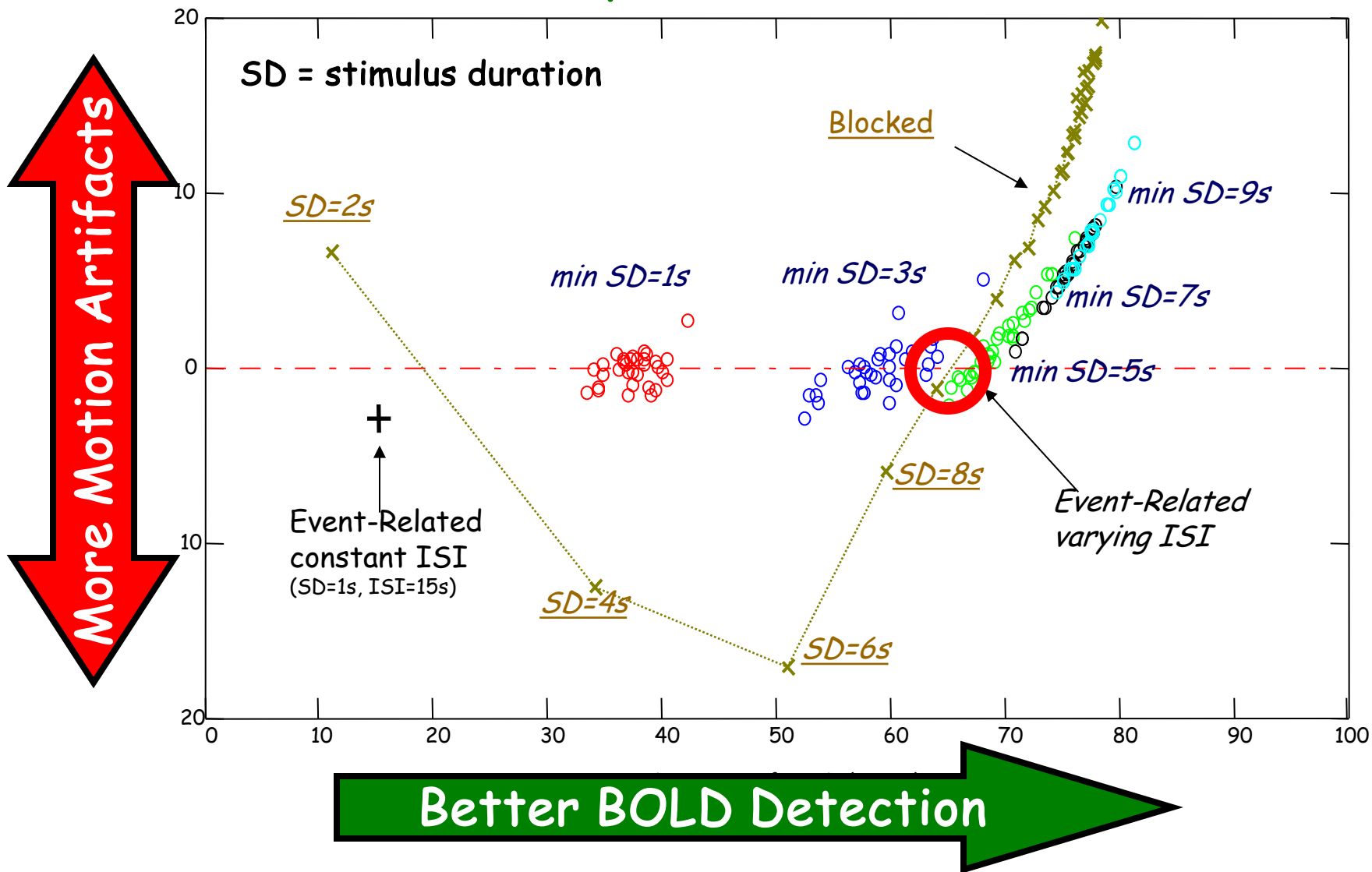

Overt Responses

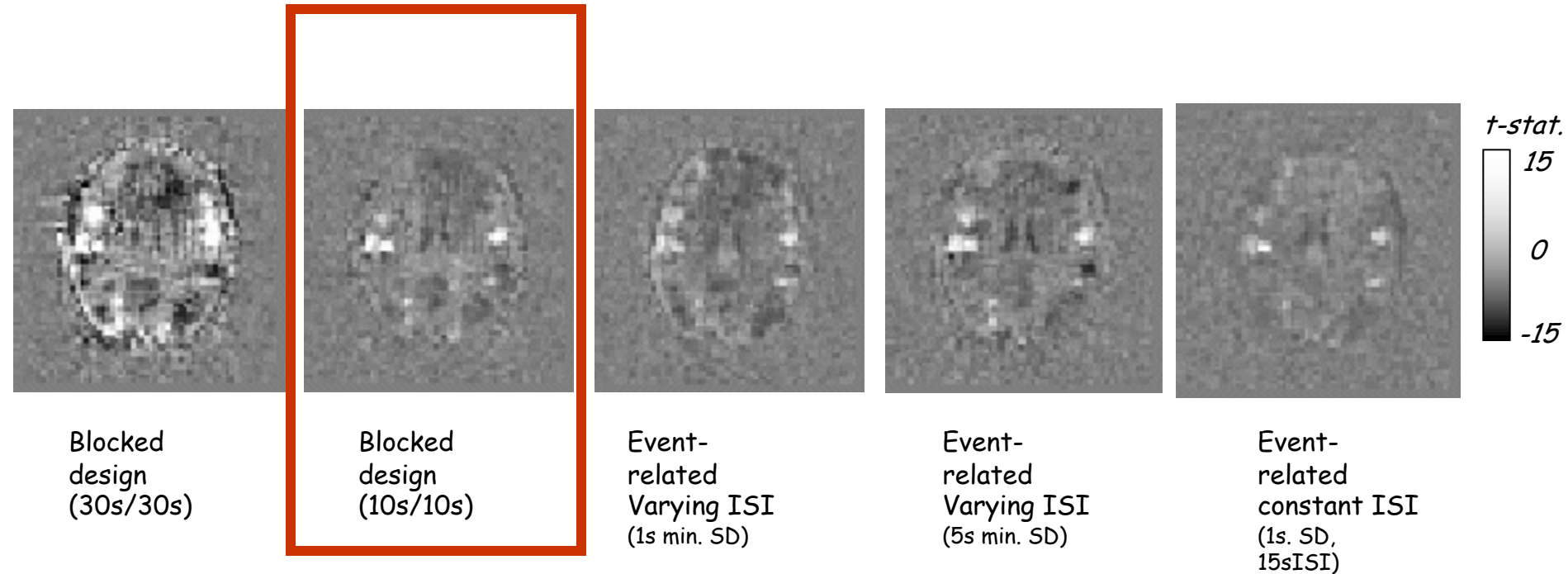

8 channel parallel receiver coil

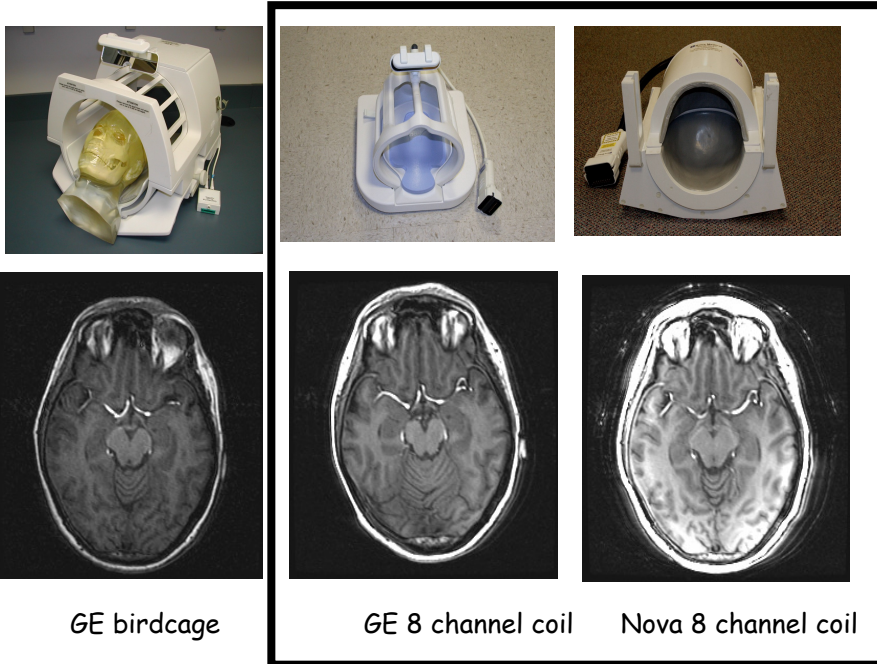

16 channel parallel receiver coil

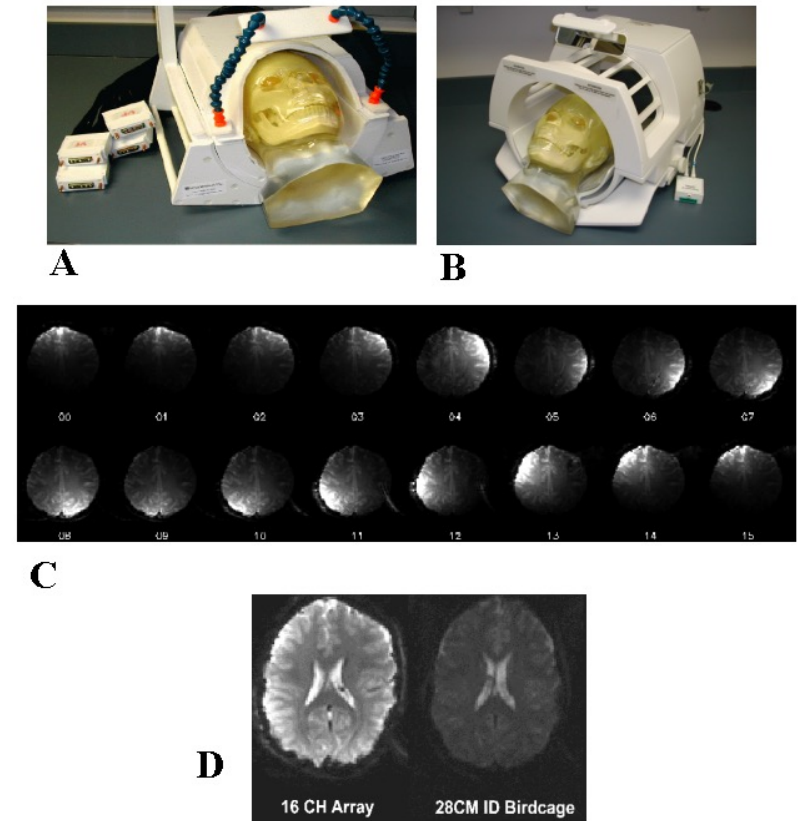

Finding the "suggested voxel volume"

Temporal Signal to Noise Ratio (TSNR) vs. Signal to Noise Ratio (SNR)

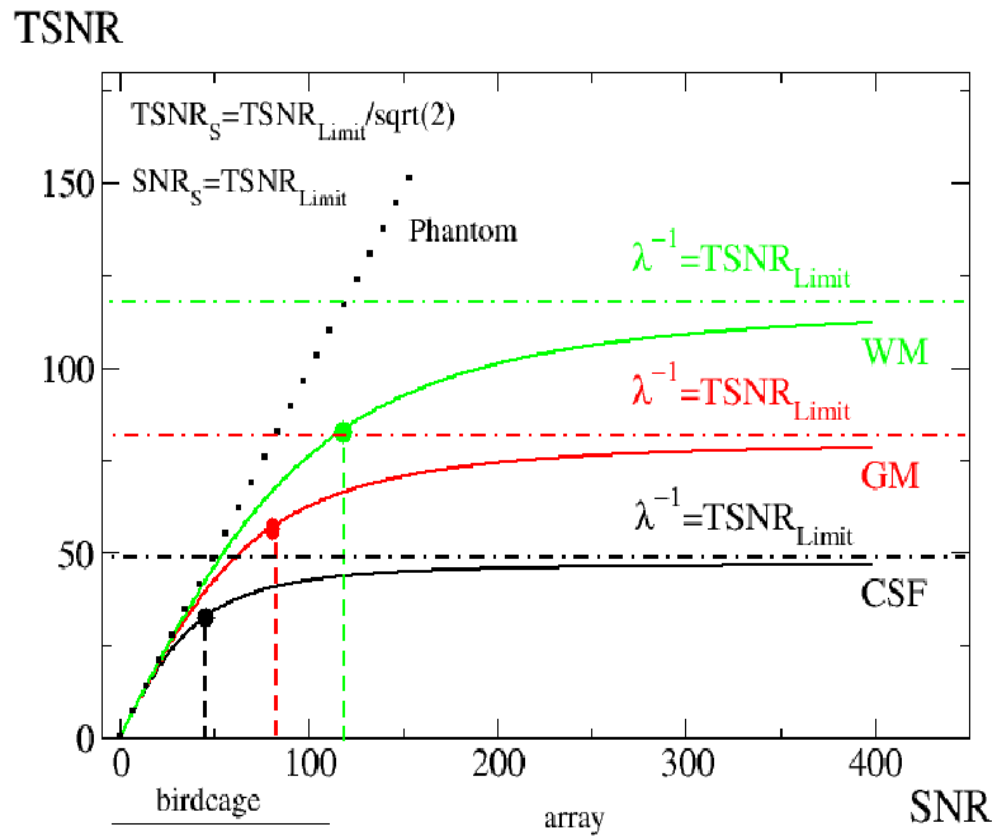

3T, birdcage:	2.5 mm ³
3T, 16 channel:	1.8 mm ³
7T, 16 channel:	1.4 mm ³

Segmentation using EPI Transient

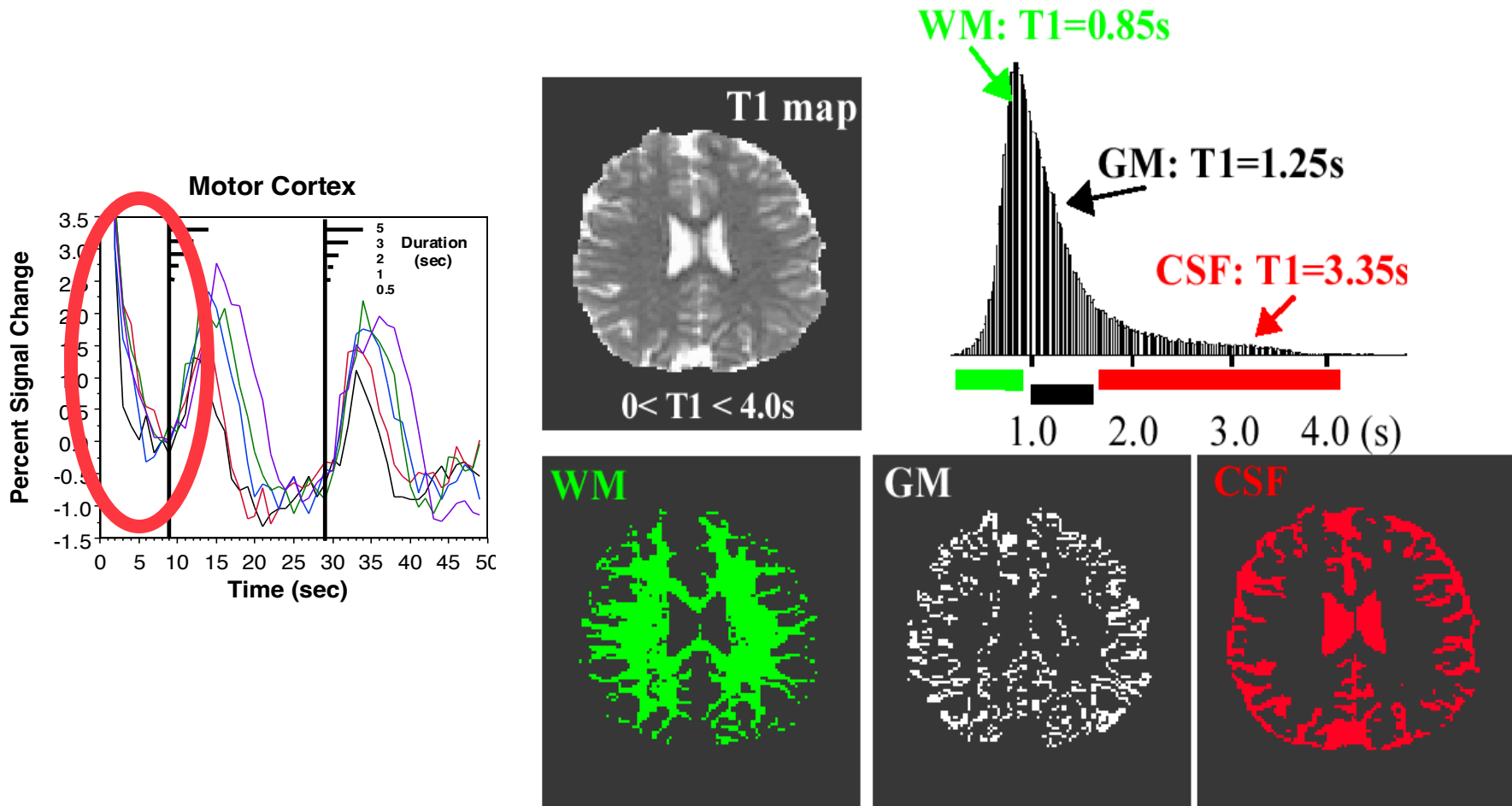

Sensitivity, Scan Time, and Temporal Signal to Noise

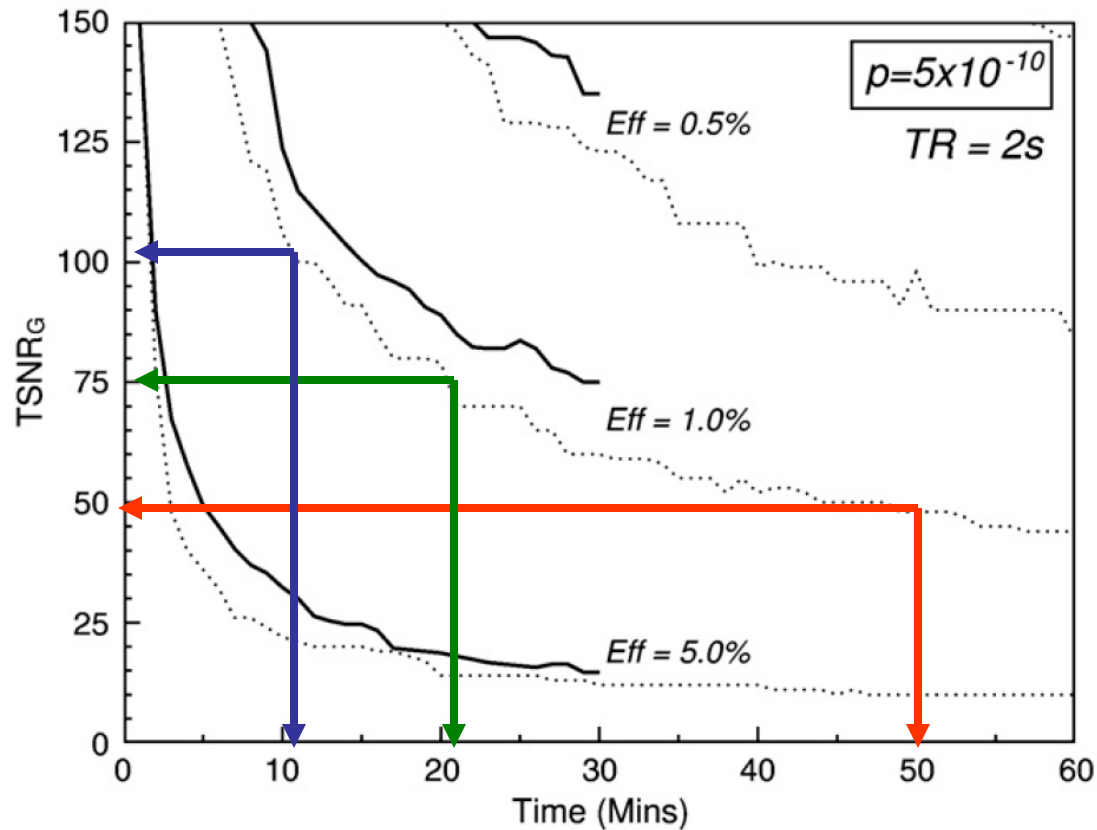

4. Pattern-Information Analysis

Motivation:

- Classical fMRI analysis:
Is a region activated during a task?
- Pattern-information analysis:
Does a region carry a particular kind of information?

Study:

- Pattern-Information Mapping
- Dis-similarity matrix



Pattern Information Mapping

"searchlight" ROI →

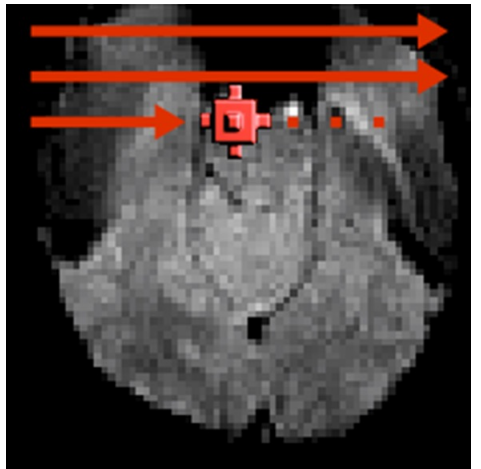
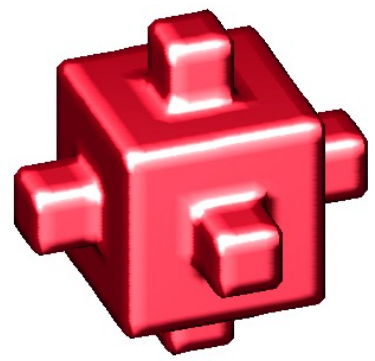

From fixed ROI

event-related spatial response patterns

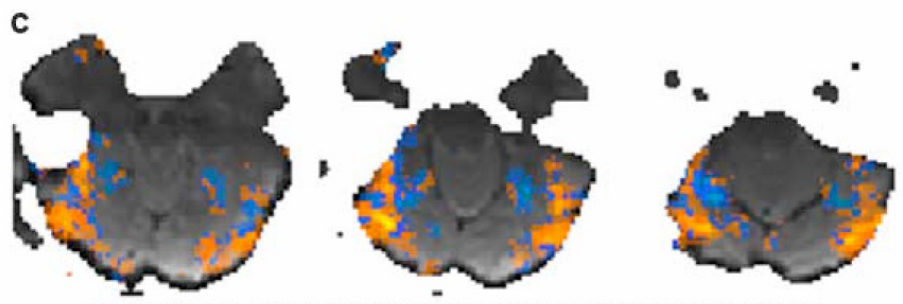
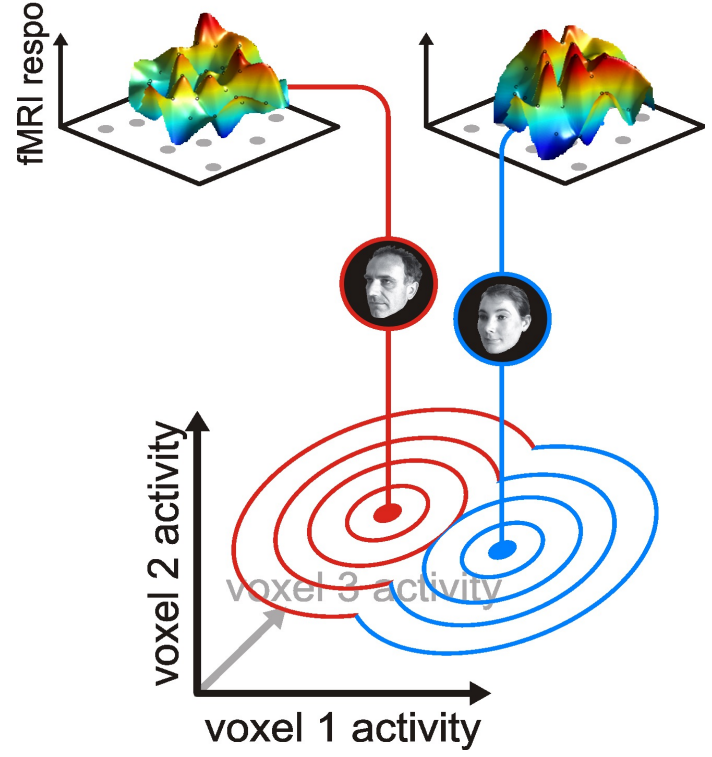

Information-based searchlight map with t-map texture (FDR $q < 0.05$)



Unsmoothed-data t map (same number of voxels marked)

Dissimilarity Matrix Creation

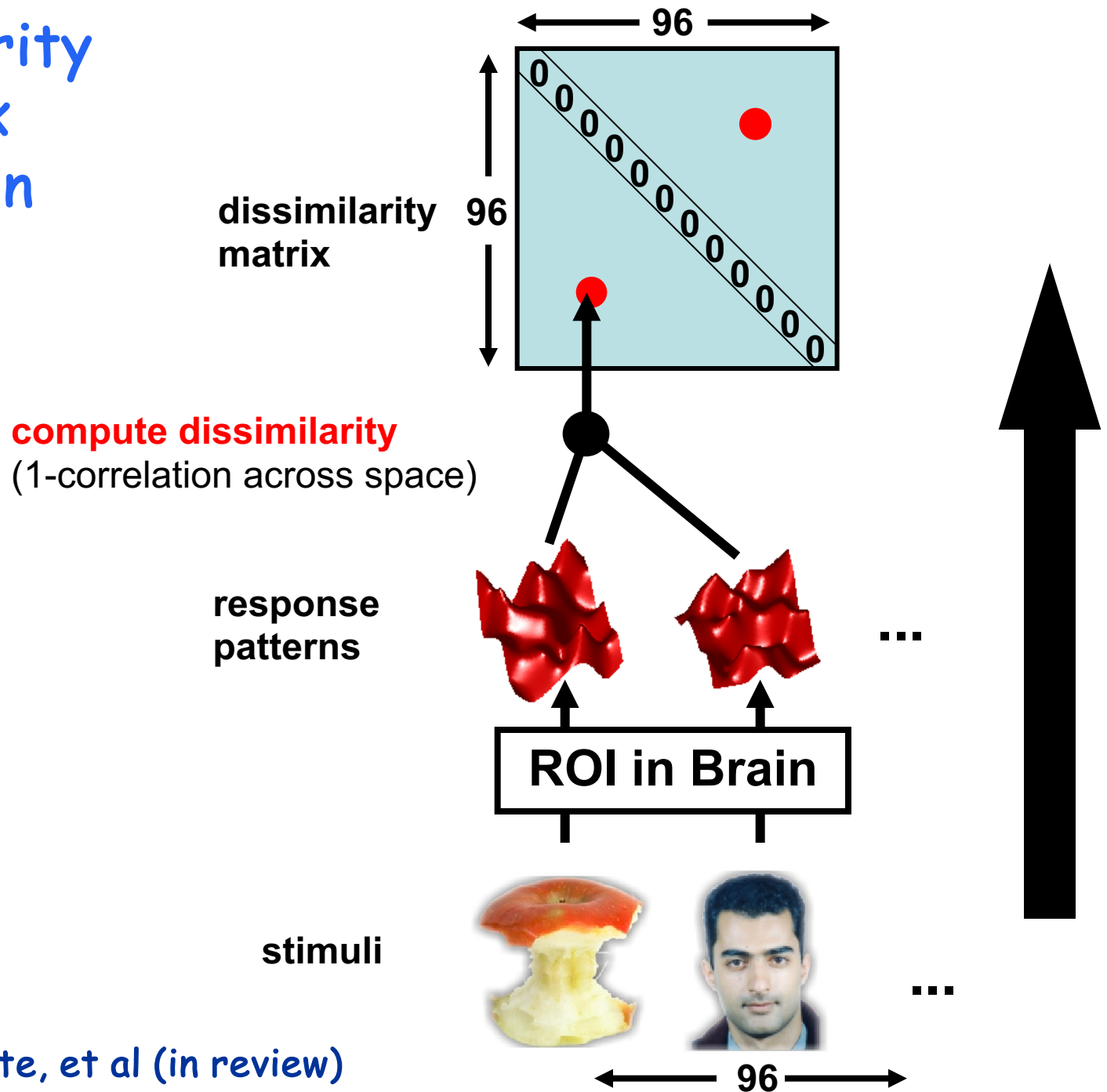

Human IT

(1000 visually most responsive voxels)

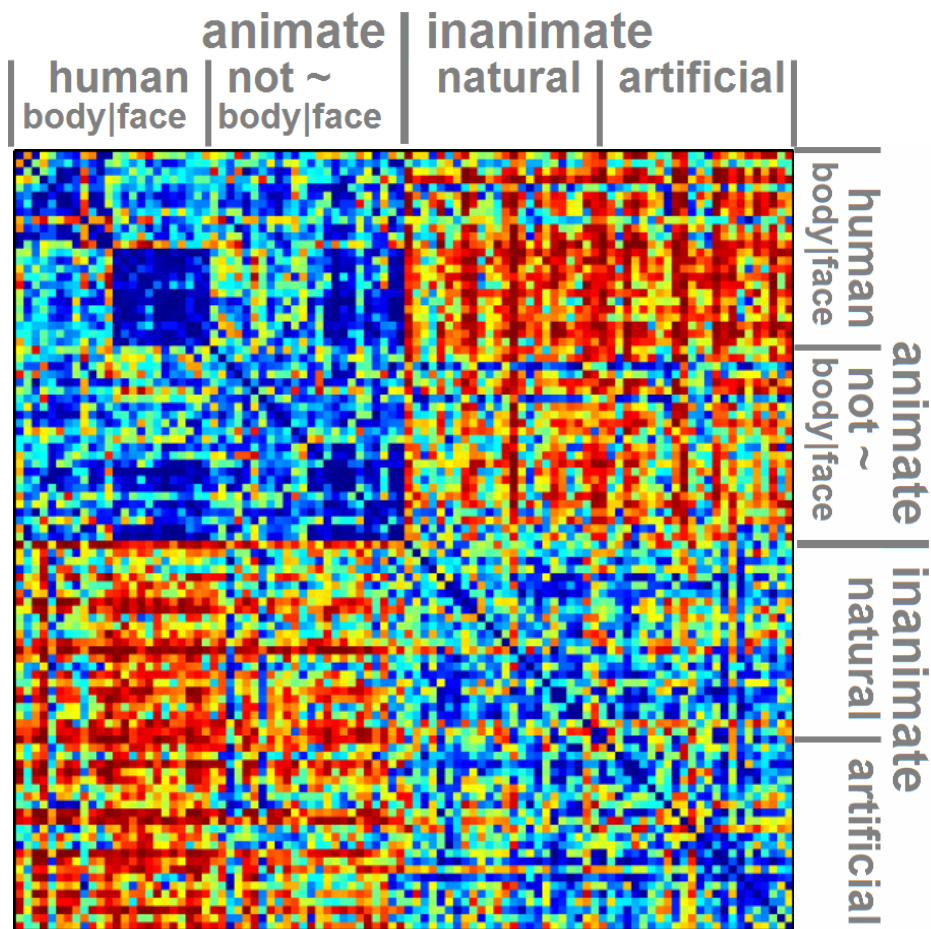

Human Early Visual Cortex

(1057 visually most responsive voxels)

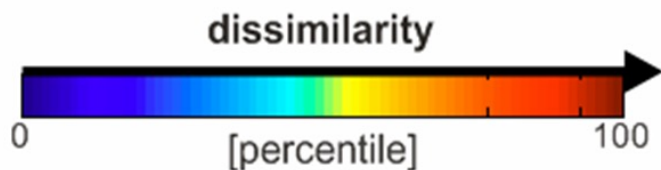
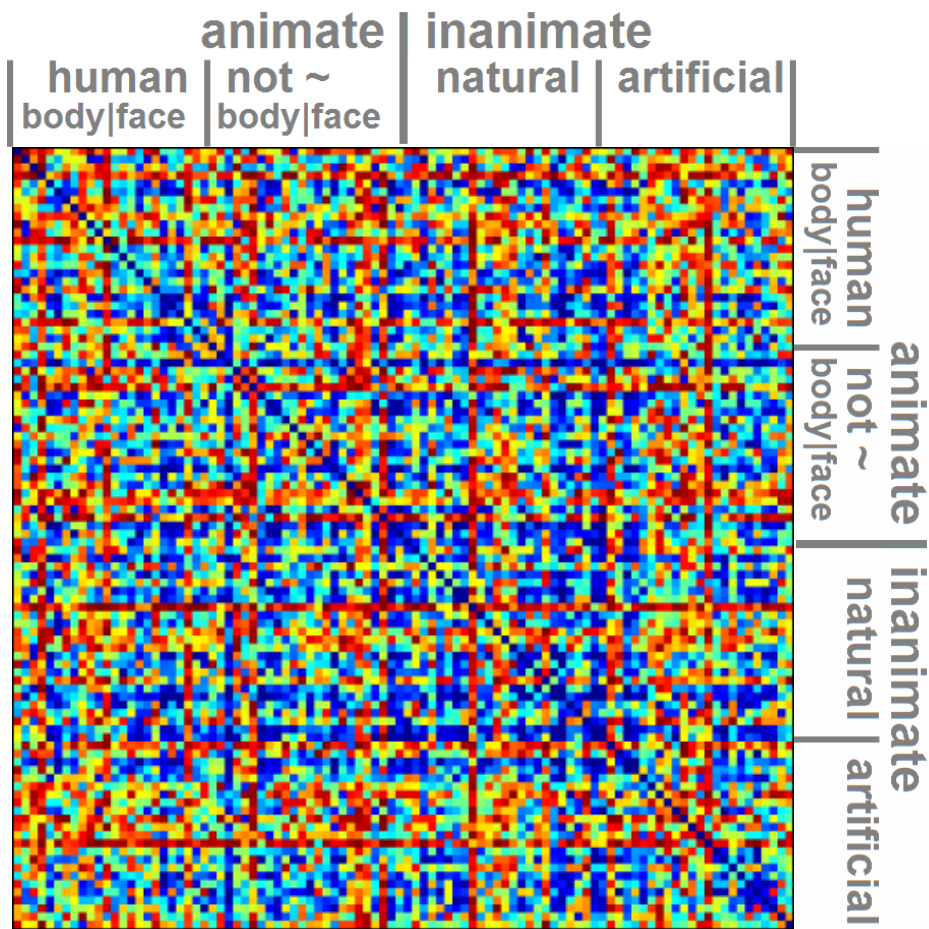

Monkey-Human Comparison Procedure

Human

- fMRI in four subjects
(repeated sessions,
>12 runs per subject)
- "quick" event-related
design
(stimulus duration: 300ms,
stimulus onset asynchrony: 4s)
- fixation task
(with discrimination of fixation-point
color changes)
- occipitotemporal
measurement slab
(5-cm thick)
- small voxels ($1.95 \times 1.95 \times 2 \text{mm}^3$)
- 3T magnet, 16-channel coil
(SENSE, acc. fac. 2)

Monkey (Kiani et al. 2007)

- single-cell recordings
in two monkeys
- rapid serial presentation
(stimulus duration: 105ms)
- fixation task
- electrodes in anterior IT
(left in monkey 1, right in monkey 2)
- 674 cells total
- windowed spike count
(140-ms window starting 71ms after
stimulus onset)

5. Neuronal Current MRI

Motivation:

- Direct fMRI of neuronal activity.

Studies:

- Model
- Phantom Studies
- Cell Cultures at 7T and 3T

Magnetic Field

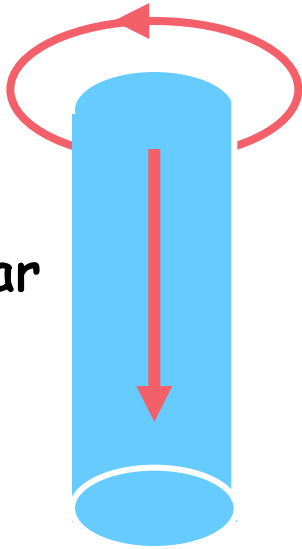

Intracellular
Current

Surface Fields

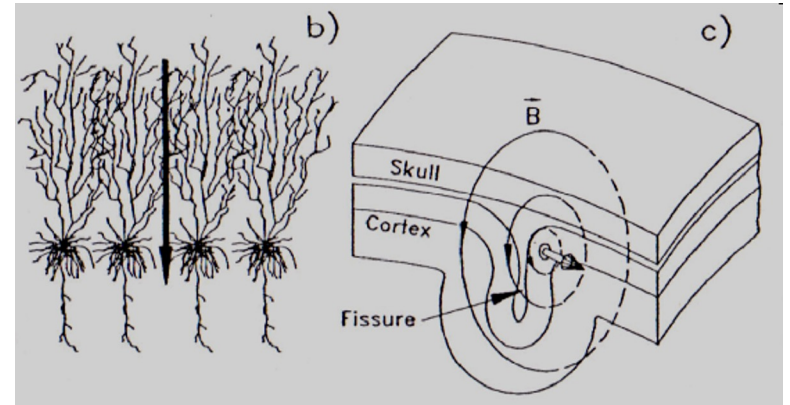
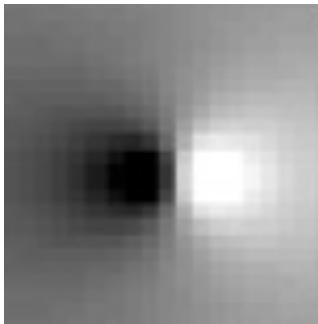

100 fT at on the scalp

J.P. Wikswo Jr et al. *J Clin
Neurophys* 8(2): 170-188, 1991

Magnetic field associated with a bundle of dendrites

Because $B_{MEG} = 100 \text{ fT}$ is measured by MEG on the scalp

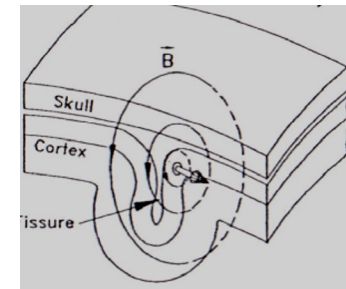

at least 50,000 neurons (0.002 fT (per dendrite) $\times 50,000 = 100 \text{ fT}$), must coherently act to generate such field. These bundles of neurons produce, within a typical voxel, $1 \text{ mm} \times 1 \text{ mm} \times 1 \text{ mm}$, a field of order:

$$B_{MRI} = B_{MEG} \left(\frac{r_{MEG}}{r_{MRI}} \right)^2 = B_{MEG} \left(\frac{4 \text{ cm}}{0.1 \text{ cm}} \right)^2 = 1600 B_{MEG} \quad B_{MRI} \approx 0.2 \text{ nT}$$

Surface Field Distribution Across Spatial Scales

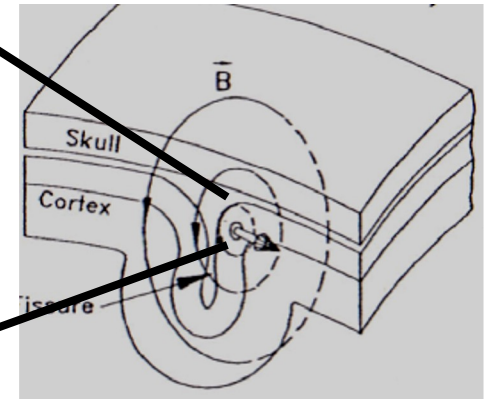
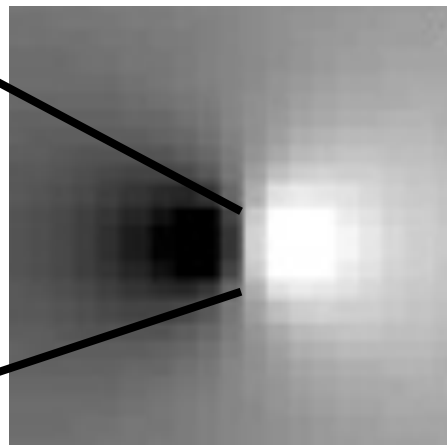
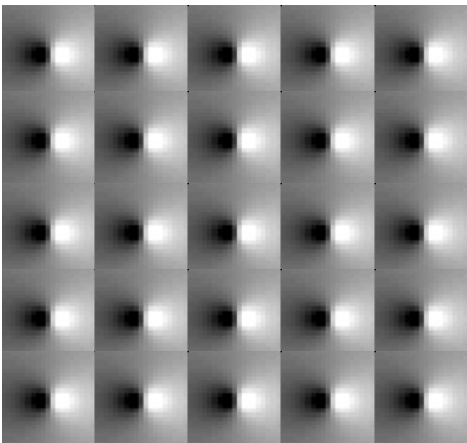
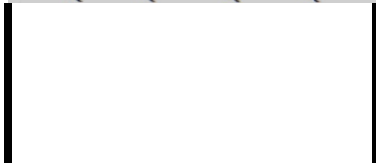
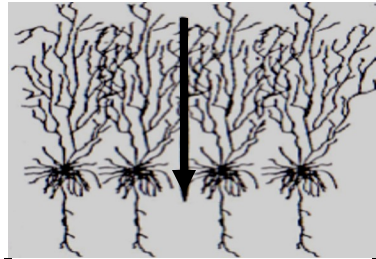

Adapted from: J.P. Wikswo Jr et al.
J Clin Neurophy 8(2): 170-188, 1991

Current Phantom Experiment

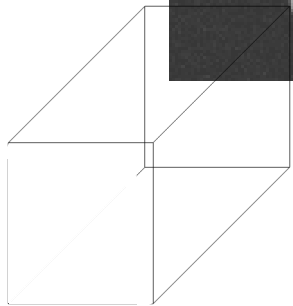
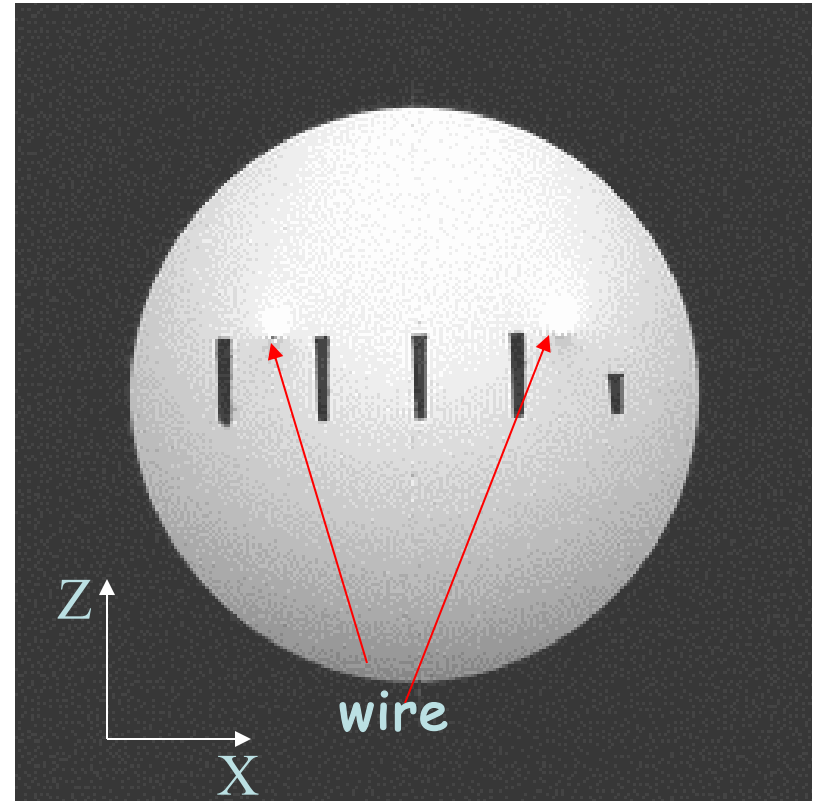
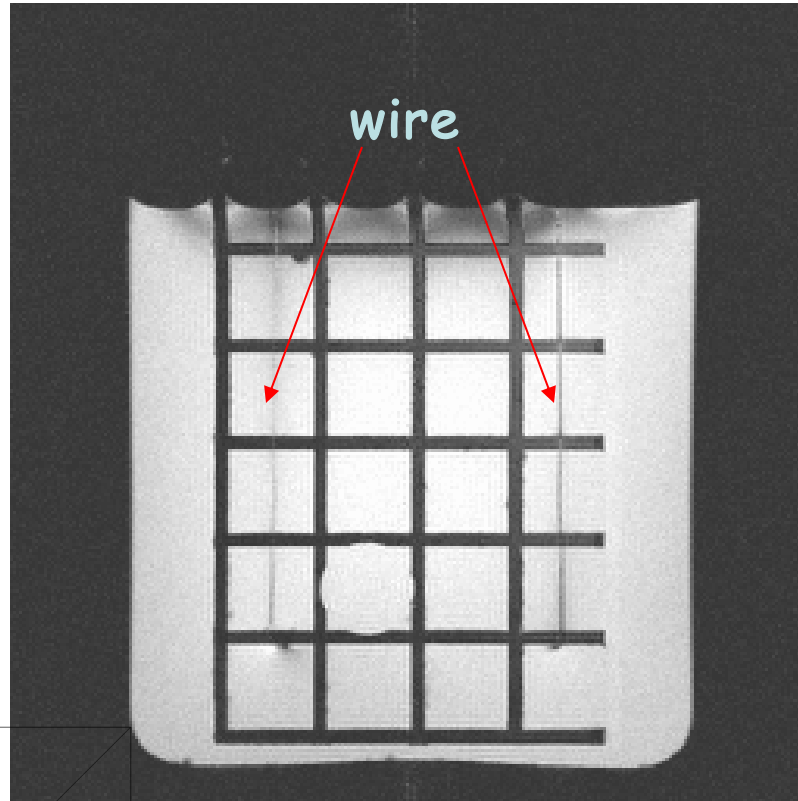

calculated $B_c \parallel B_0$

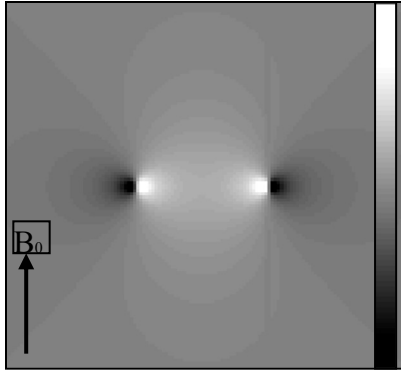

$\Delta\phi \cong 20^\circ$

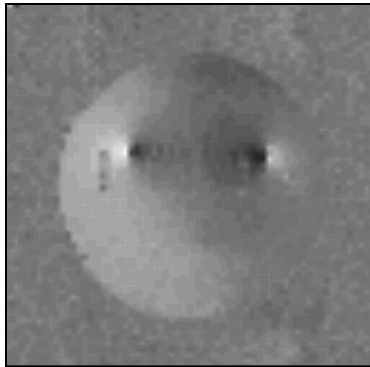

Correlation image

Measurement

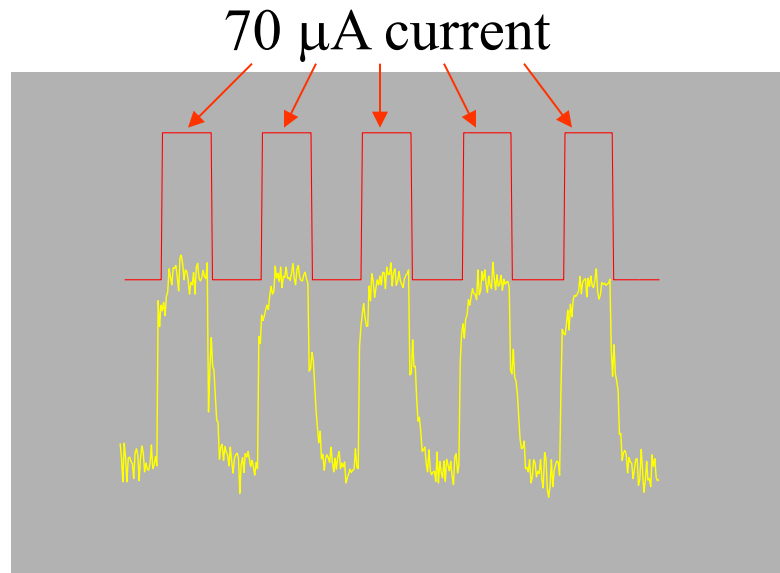

Single shot GE EPI

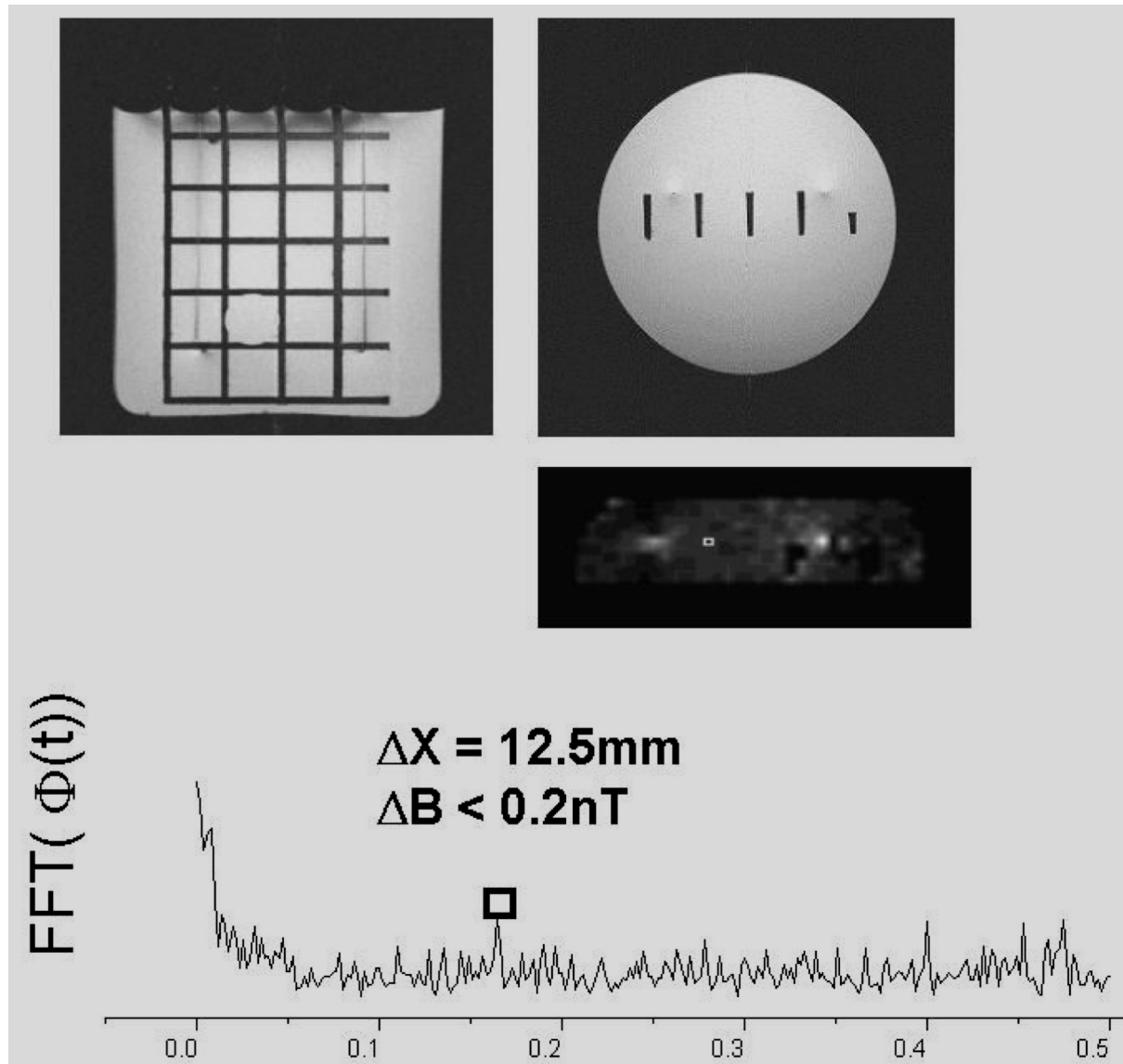

J. Bodurka, P. A. Bandettini. *Magn. Reson. Med.* 47: 1052-1058, (2002).

in vitro model

Organotypic (*no blood supply or hemoglobin traces*) sections of newborn-rat somato-sensory Cortex & Basal Ganglia

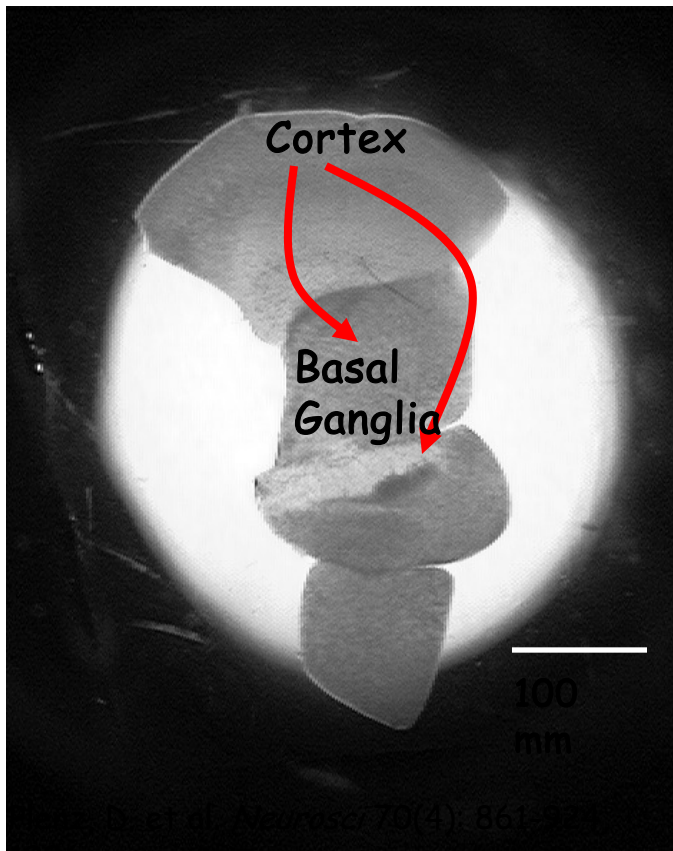

- Size: in-plane: $\sim 1-2\text{mm}^2$, thickness: $60-100\mu\text{m}$
- Neuronal Population: $10,000-100,000$
- Spontaneous synchronized activity $< 2\text{Hz}$
- Epileptiform activity
- Spontaneous beta freq. activity ($20-30\text{Hz}$)
- Network Activity Range: $\sim 0.5-15\mu\text{V}$

Culture Preparation

Multi-Electrode Arrays (MEA)

Multichannelsystems Germany 8x8 electrodes

0.8ml culture medium

Multi-Electrode Array

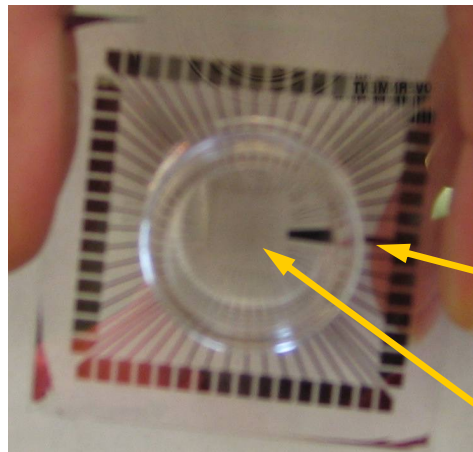

Reference
electrode

Culture site

10mm

Multi-Electrode Array EEG recording

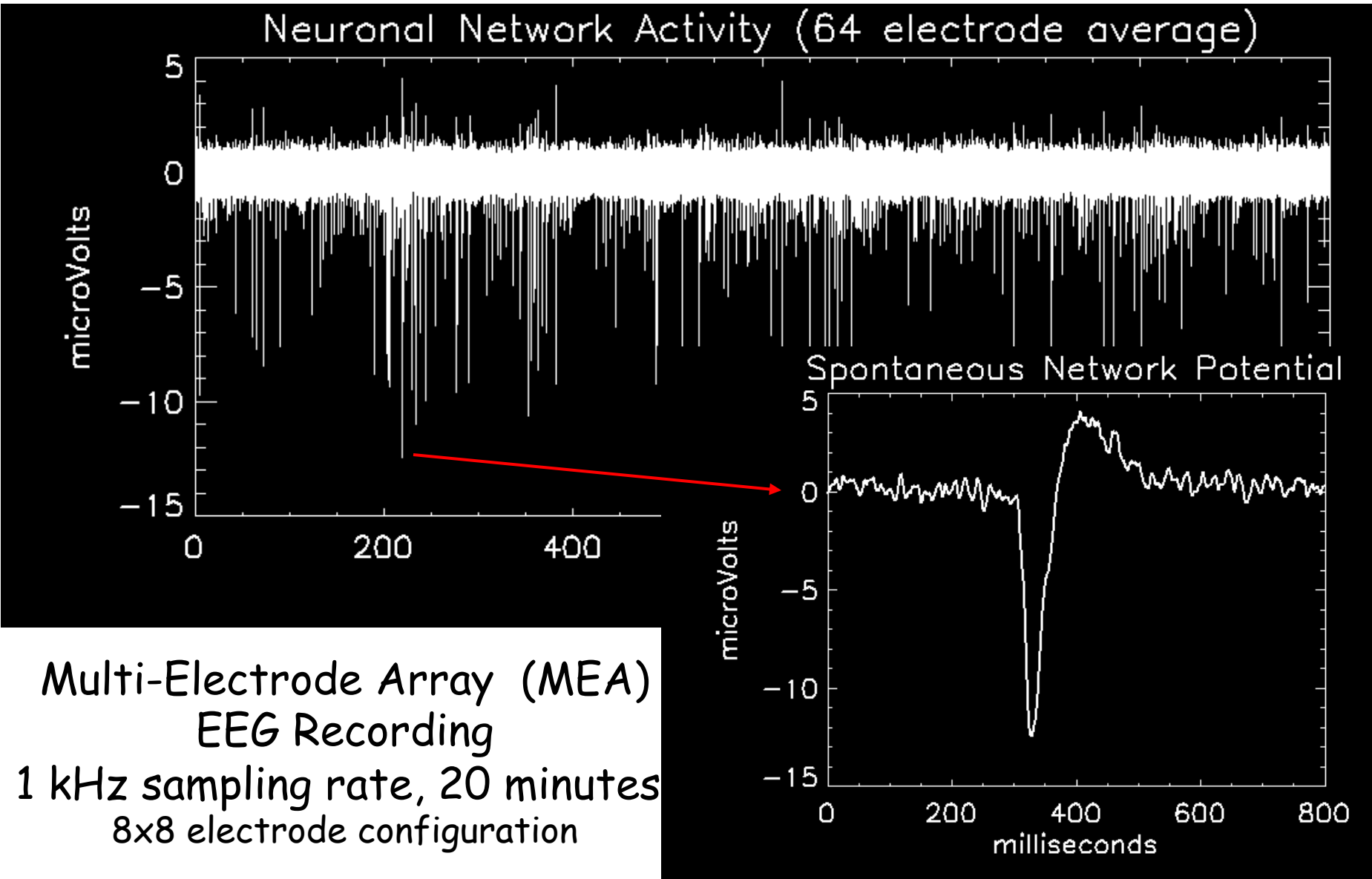

in vitro MR protocol

Imaging (3T)

- Spin-Echo EchoPlanar Imaging

SE EPI
image



- voxel size: $\sim 3 \times 3 \times 3$ mm
- Sampling Rate :1 Hz (TR: 1sec)
- TE: 60 ms
- Readout :44 ms

NMR (7T)

- free induction decay (FID) acquisition

FID

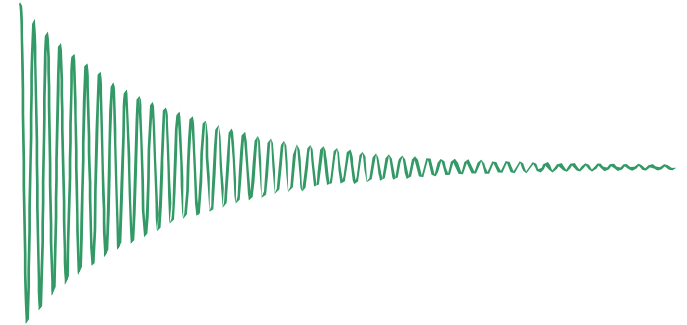

- slab size: $\sim 2 \times 10 \times 1$ mm
- Sampling Rate :10 Hz (TR: 100ms)
- TE : 30 ms
- Readout : 41 ms

in vitro MR experiment design

Imaging (3T)

Six Experiments

Active : 10 min (600 images) neuronal activity present

Inactive : 10 min (600 images) neuronal activity terminated via TTX administration

NMR (7T)

Six Experiments

Active : ~17 min (10,000 images) neuronal activity present

Inactive : ~17 min (10,000 images) neuronal activity terminated via TTX administration

Pre- and Post- MR scan electrical recordings

3 Tesla data

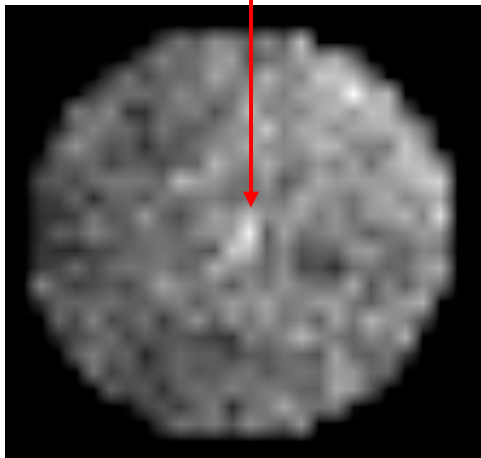
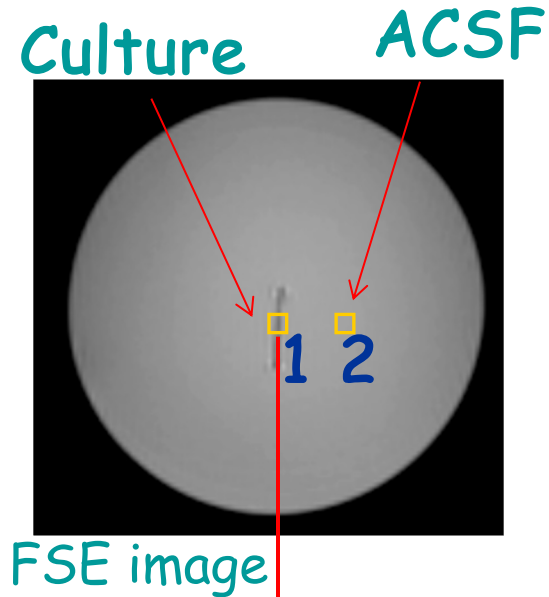

1: culture

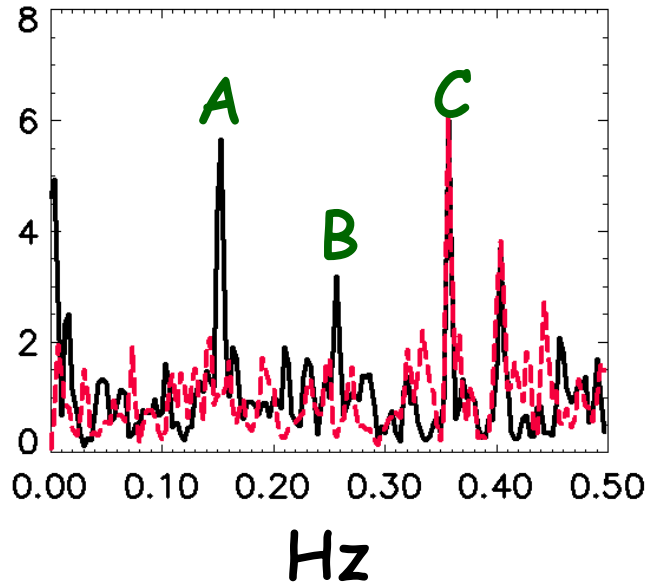

2: ACSF

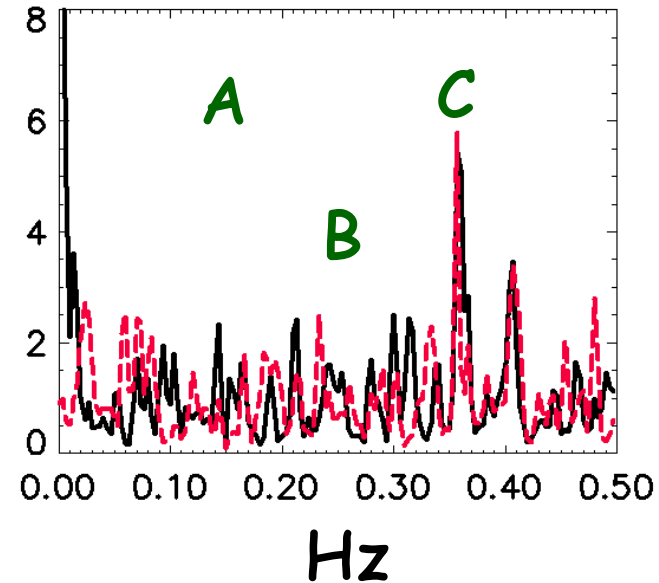

Active condition: black line
Inactive condition: red line

A: 0.15 Hz activity, on/off frequency
B: activity
C: scanner noise (cooling-pump)

7 Tesla data

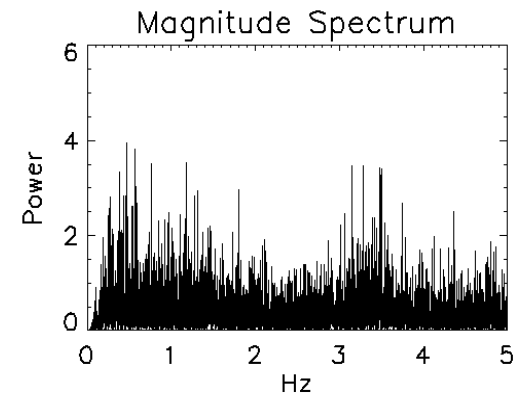
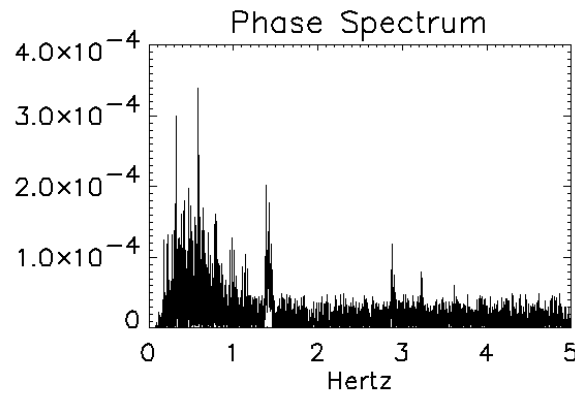
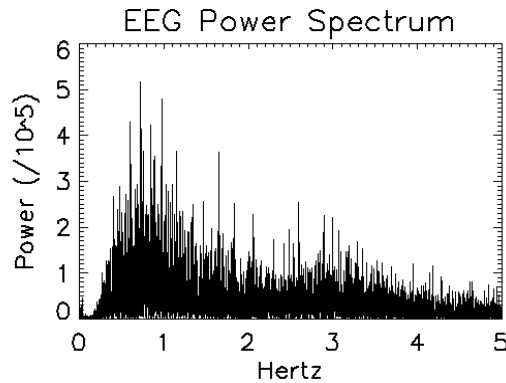

TTX

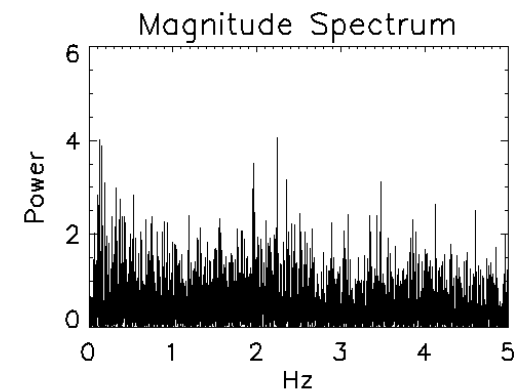
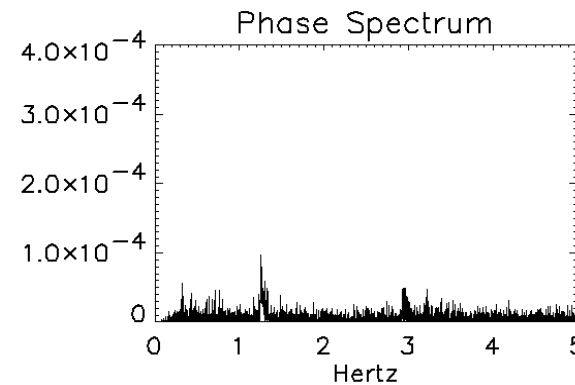
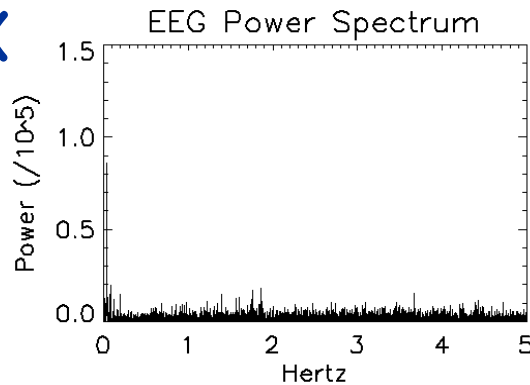

Power decrease between PRE & TTX EEG : ~ 81% Decrease between PRE & TTX MR phase: ~ 70% Decrease between PRE & TTX MR magnitude: ~ 8%

N. Petridou, D. Plenz, A. C. Silva, J. Bodurka, M. Loew, P. A. Bandettini,
Proc. Nat'l. Acad. Sci. USA. 103, 16015-16020 (2006).

1. Dynamics

2. Fluctuations

3. Experimental Design

4. Pattern Information

5. Neuronal Current MRI



September, 1991

Section on Functional Imaging Methods

Rasmus Birn	staff scientist
Anthony Boemio	post doc
Justin Edmands	system admin
Dan Handwerker	post doc
Tyler Jones	post bac IRTA
Youn Kim	post bac IRTA
Niko Kriegeskorte	post doc
Marieke Mur	student IRTA
Kevin Murphy	post doc
Alissa Par	post bac IRTA
Vikas Patel	system admin
Dorian Van Tassell	program assistant

Javier Castillo-Gonzalez	Summer Student
Jason Diamond	Howard Hughes Fellow
Thomas Gallo	Summer Student
Hauke Heekeren	post doc
David Knight	post doc
Ilana Levy	post bac IRTA
Marta Maieron	visiting fellow
Hanh Nguyen	post bac IRTA
Natalia Petridou	student IRTA
Douglass Ruff	post bac IRTA
Monica Smith	post bac IRTA
August Tuan	post bac IRTA
Naja Waters	post bac IRTA

Functional MRI Facility

Jerzy Bodurka	staff scientist
Ellen Condon	technologist
Janet Ebron	technologist
Kenny Kan	technologist
Kay Kuhns	admin. lab manager
Wenming Luh	staff scientist
Sean Marrett	staff scientist
Marcela Montequin	technologist
Sandra Moore	technologist
Sahra Omar	technologist
Alda Ottley	technologist
Paula Rowser	technologist
Adam Thomas	system admin
Karen Bove-Bettis	technologist
James Hoske	technologist

Parameter	Description	Default value	Range evaluated
E_0	Resting oxygen extraction fraction	0.4	0.3–0.6
v_0	Resting blood volume fraction	0.03	0.03–0.18
f_0	Resting relative blood flow	0.01 s^{-1}	0.01 s–0.16 s
Δf	Fractional blood flow change	0.4	–
α	Steady-state flow–volume relationship	0.4	0.25–1.0
τ_{MTT}	Blood mean transit time (v_0/f_0)	3 s	1.1 s–18 s
τ_+	Viscoelastic time constant (inflation)	20 s	10 s–40 s
τ_-	Viscoelastic time constant (deflation)	20 s	10 s–40 s
a_1	Weight for deoxyhemoglobin change	3.7	2.8–5.6
a_2	Weight for blood volume change	1.1	0.7–1.9

ON response amplitude: initial amp:	1.5 times steady state amp
Adaptation time constant:	1.5s
Refractory period:	5s
OFF response amplitude:	initial amp 0.5 times steady state amp
OFF response time constant:	0.5s

The initial overshoot amplitude and decay time were chosen to roughly match the local field potential change measured in macaque visual cortex in response to rotating checkerboard, as measured by Logothetis et al. (2001).

The refractory period was chosen to produce results somewhat consistent with observed BOLD refractory period (Huettel et al., 2000).

